

FOREWORD

Dear Customer,

Thank you for selecting your new Kia vehicle.

As a global car manufacturer focused on building high-quality vehicles with exceptional value, Kia is dedicated to providing you with a customer service experience that exceeds your expectations.

This Owner's Manual will acquaint you with the operation of features and equipment that are either standard or optional on this vehicle, along with the maintenance needs of this vehicle. Therefore, you may find certain descriptions and illustrations not applicable to your vehicle. You are advised to read this publication carefully and follow the instructions and recommendations. Please always keep this manual in the vehicle for your and any subsequent owner's reference.

If you need technical assistance, visit an authorized Kia dealership where factory trained technicians, recommended special tools, and genuine Kia replacement parts can be provided.

All information contained in this Owner's Manual was accurate at the time of publication. However, as Kia continues to make improvements to its products, the company reserves the right to make changes to this manual or any of its vehicles at any time without notice and without incurring any obligations.

Please drive safely, and enjoy your Kia vehicle!

© 2022 Kia Corporation

All rights reserved. May not be reproduced or translated in whole or in part without the written consent of Kia Corporation.

Printed in Korea

How to use this manual

We want to help you get the greatest possible driving pleasure from your vehicle. Your Owner's Manual can assist you in many ways.

We strongly recommend that you read the entire manual. In order to minimize the chance of death or injury, you must read the WARNING and CAUTION sections in the manual.

Illustrations complement the words in this manual to best explain how to enjoy your vehicle. By reading your manual, you learn about features, important safety information, and driving tips under various road conditions.

The general layout of the manual is provided in the Table of Contents. Use the index when looking for a specific area or subject, it has an alphabetical listing of all information in your manual.

Chapters: This manual has nine chapters plus an index. Each chapter begins with a brief list of contents so you can tell at a glance if that chapter has the information you want.

You will find various WARNINGS, CAUTIONS, and NOTICES in this manual. These WARNINGS were prepared to enhance your personal safety. You should carefully read and follow ALL procedures and recommendations provided in these WARNINGS, CAUTIONS and NOTICES.

WARNING

A WARNING indicates a situation in which harm, serious bodily injury or death could result if the warning is ignored.

CAUTION

A CAUTION indicates a situation in which damage to your vehicle could result if the caution is ignored.

NOTICE

A NOTICE indicates interesting or helpful information is being provided.

Table of Contents

Hybrid system overview	①
Introduction	②
Your vehicle at a glance	③
Safety features of your vehicle	④
Features of your vehicle	⑤
Driving your vehicle	⑥
What to do in an emergency	⑦
Maintenance	⑧
Specifications & Consumer information	⑨
Abbreviation	Ⓐ
Appendix	
Index	Ⓛ

Hybrid system overview

1

PHEV (Plug-in Hybrid Electric Vehicle) system	1-2
HEV (Hybrid Electric Vehicle) system.....	1-3
Charging the plug-in hybrid vehicle	1-4
• Charging information.....	1-4
• Charging time.....	1-4
• Charging types.....	1-4
• Charging status.....	1-5
• AC charging connector lock.....	1-7
• Scheduled charging.....	1-7
• Charging precautions.....	1-8
• AC charger.....	1-9
• Trickle charger (portable charging cable).....	1-10
• How to disconnect charging connector in emergency.....	1-15
Driving the hybrid/plug-in hybrid vehicle	1-16
• Starting the vehicle.....	1-16
• EV button.....	1-16
• Special features	1-17
• Hybrid system gauge.....	1-19
• Warning and indicator lights.....	1-19
• LCD display messages.....	1-20
• Energy flow.....	1-26
Components of the hybrid/plug-in hybrid vehicle	1-30
• Plug-in hybrid vehicle components.....	1-30
• Hybrid vehicle components.....	1-33
• High voltage service interlock connector.....	1-36
• If an accident occurs.....	1-36
• When the hybrid vehicle shuts off.....	1-37

Hybrid system overview

PHEV (Plug-in Hybrid Electric Vehicle) system

The Kia Plug-in Hybrid Electric Vehicle (PHEV) shares the characteristics of both a conventional hybrid electric vehicle and an all-electric vehicle.

When used as a conventional hybrid electric vehicle, the HEV computer selectively operates between the engine and the electric motor or even both at the same time.

When it is operating in the electric vehicle mode, the vehicle is driven only using the electric motor over a certain distance until the hybrid battery becomes low. The driving distance in EV mode depends on customer driving style and road conditions.

Aggressive driving maneuvers may at times temporarily enable the engine to operate.

The engine power could be limited during emission reduction control period at cold engine condition.

The hybrid battery can be fully charged by connecting a plug to an external electric power source.

An engine can be turned on due to factors such as heater and a frequent operation of the accelerator pedal by a driver in CD mode.

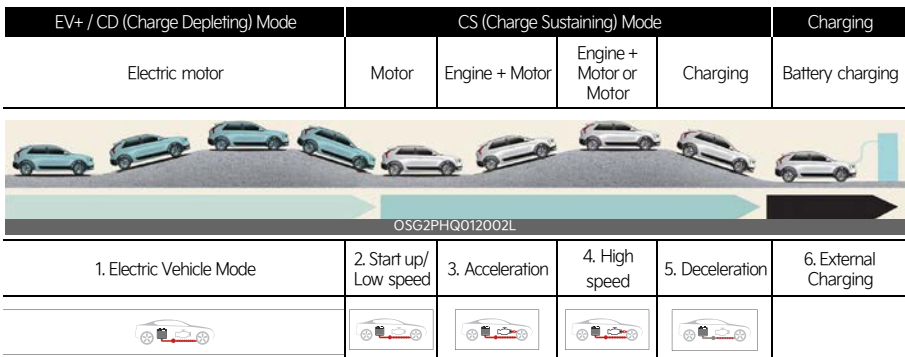

HEV (Hybrid Electric Vehicle) system

The Kia Hybrid Electric Vehicle (HEV) uses both the gasoline engine and the electric motor for power. The electric motor is run by a high-voltage HEV battery.

Depending on the driving conditions, the HEV computer selectively operates between the engine and the electric motor or even both at the same time.

Fuel efficiency increases when the vehicle is driven by the electric motor with the HEV battery.

The HEV battery charge must be maintained, so at times the engine will come on even at idle to act as a generator. Charging also occurs when decelerating or by regenerative braking.

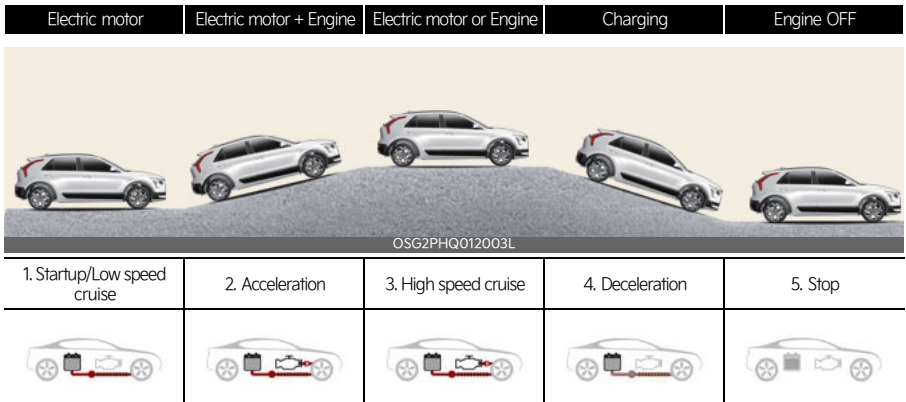

Charging the plug-in hybrid vehicle

Charging information







- AC Charger: The plug-in hybrid vehicle is charged by plugging into a AC charger installed in your home or a public charging station. (For further details, refer to "AC charger" on page 1-9.)
- Trickle Charger: The plug-in hybrid vehicle can be charged by using household electricity.

The electrical outlet in your home must comply with regulations and can safely accommodate the Voltage/Current (Amps)/Power (Watts) ratings specified on the trickle charge. Use only as a backup charger.

Charging time

- AC Charger: Takes about 2 hours 55 minutes at room temperature when charged from 15 to 100%. Depending on the condition and durability of the high-voltage battery, charger specifications, and ambient temperature, the time required for charging the high-voltage battery may vary.
- Trickle Charger: For charging at home. Please note that the Trickle Charger is slower than the AC Charger.

Charging types

Category	Charging Inlet (Vehicle)	Charging Connector	Charging Outlet	Charging Method	Charging Time
AC Charger	 OSG2PHQ012021L	 OCVQ011005L	 OCVQ011007L	AC charger installed in homes or public charging stations	Approximately 2 hours 55 minutes at room temperature when charged from 15 to 100%.
Trickle Charger	 OSG2PHQ012021L	 OCVQ011005L	 OCVQ011009L	Household current	For charging at home. Please note that the Trickle Charger is slower than the AC Charger

- Depending on the condition and durability of the high voltage battery, charger specifications, and ambient temperature, the time required for charging the high voltage battery may vary.
- Actual charger image and charging method may vary in accordance with the charger manufacturer.

Charging status



When charging the high voltage battery, the charge level can be checked from outside the vehicle.

It takes about 2 ~ 3 hours or more to complete charging.

1

Operation of charging indicator lamp				
Status		(1)	(2)	(3)
READY	Non-charging state	OFF	OFF	OFF
Status On	Main Relay ON status ON	OFF	OFF	Blinking
Charging	0~35%	Blinking	OFF	OFF
	35~65%	ON	Blinking	OFF
	65%~	ON	ON	Blinking
Charging complete	Charging completed (turns off in 5 seconds)	ON	ON	ON
Charging failed	Error while charging	Blinking	Blinking	Blinking
Scheduled charging standby	Reserved charging is operating (turns OFF after 3 minutes)	OFF	Blinking	OFF

Checking charging status



You can check the charging status at the outside of vehicle when charging or using (it is not driving status) the high-voltage battery.

It takes about 2 ~ 3 hours or more to complete charging.

For more information about charging status indicator, refer to "Charging status" on page 1-5.

How to disconnect AC charger

1. The vehicle doors must be unlocked in order to be able to disconnect the charging connector. A lock system prevents charger cable disconnection when the vehicle's doors are locked.

* NOTICE

In order to disconnect the charging connector, unlock the doors to unlatch the charging connector lock system. If not, the charging connector and the vehicle's charging inlet may be damaged.

2. Hold the charging connector handle and pull it out.



To prevent charging cable theft, the charging connector cannot be dis-

connected from the inlet when the doors are locked.

However, if the vehicle is in the charging connector AUTO mode, the charging connector automatically unlocks from the inlet when charging is completed.

If the connector is not automatically unlocked after charging is completed in AUTO mode, the connector is unlocked when all of the doors are unlocked.

For more details, refer to "AC charging connector lock" on page 1-7.

* NOTICE

When disconnecting the charging connector, do not try to disconnect it by force while not pressing the release button. This may damage the charging connector and vehicle charging inlet.

3. Close the charging door by pressing the rear center edge of the charging door.



* The charging door does not have a locking system.

* NOTICE

- If you cannot open the charging door due to freezing weather, tap lightly or remove any ice near the charging door. Do not try to forcibly open the charging door. If you open it by force, the charging door may be damaged.
- Do not modify or disassemble the charging cable components. It may

cause a fire or an electric shock with personal injury.

- Keep the charging connector and the charging plug clean and dry. The charging cable should be also kept dry.
- Use an air gun to blow any foreign substances from the charging connector and the charging plug.

AC charging connector lock

This AC charging connector lock function prevents an outsider from removing the charging connector from the charging inlet.

Connector lock

	Always lock	Lock while charging
Before charging	○	X
While charging	○	○
After charging	○	X

Always lock

The connector locks when the charging connector is plugged into the charging inlet. The connector is locked until all doors are unlocked by the driver. This mode can be used to prevent charging cable theft.

- If the charging connector is unlocked when all doors are unlocked, but the charging cable is not disconnected within 15 seconds, the connector will be automatically locked again.
- If the charging connector is unlocked when all doors are unlocked, but all doors are locked again, immediately, the connector will be automatically locked again.

Lock while charging

The connector locks when charging starts. The connector unlocks when charging is complete.

Scheduled charging

- You can set reserved charging using the infotainment system. Refer to the infotainment system for detailed information about setting reserved charging.
- Scheduled charging can only be done when using a AC charger or the portable charging cable (ICCB: In-Cable Control Box).
- When scheduled charging is set and the AC charger or the portable charging cable (ICCB: In-Cable Control Box) is connected for charging, the scheduled charge release button is illuminated (for 3 minutes) to indicate that scheduled charging is set.



- When scheduled charging is set, charging is not initiated immediately when the AC charger or portable charging cable (ICCB: In-Cable Control Box) is connected.
- If charging is required immediately, turn off the scheduled charge using the infotainment system or press the vehicle's scheduled charge release button () more than 2 seconds.
- When the scheduled charge is set, the charge start time is calculated by itself. In some cases, charging may

start immediately after connecting the charger.

- If you press the scheduled charging deactivation () button to immediately charge the battery, charging must be initiated 3 minutes after the charging cable has been connected.



When you press the scheduled charging deactivation () button for immediate charging, the scheduled charge setting is not completely deactivated. If you need to completely deactivate the scheduled charge setting, use the infotainment system to finalize the deactivation. Refer to "AC charger" on page 1-9 or "Trickle charger (portable charging cable)" on page 1-10 for details about connecting the AC charger and the portable charger (ICCB: In-Cable Control Box).

Charging precautions

AC Charger



⚠ WARNING

Fires caused by dust or water

Do not connect the charging cable connector plug to the vehicle if there is water or dust on the charging inlet. Connecting while there is water or dust on the charging cable connector and plug may cause a fire or electric shock. There may be a risk of fire and injury when using old worn out public electrical outlets.

⚠ WARNING

Interference with electronic medical devices

When using medical electric devices such as an implantable cardiac pacemaker, make sure to ask the medical team and manufacturer whether charging your electric vehicle will impact the operation of the medical devices. In some instances, electromagnetic waves that are generated from the charger can seriously impact medical electric devices such as an implantable cardiac pacemaker.

⚠ WARNING

Touching the charging connector

Do not touch the charging connector, charging plug, and the charging inlet when connecting the cable to the charger and the charging inlet on the vehicle. Doing so may result in electrocution.

- Comply with the following in order to prevent electrical shock when charging:
 - Use a waterproof charger
 - Make sure to not touch the charging connector and charging plug when your hand is wet

- Do not charge when there is lightning
- Do not charge when the charging connector and plug is wet

⚠ WARNING

Charging cable

- Immediately stop charging when you find abnormal symptoms (smell, smoke, etc.).
- Replace the charging cable if the cable coating is damaged to prevent electrical shock.
- When connecting or removing the charging cable, make sure to hold the charging connector handle and charging plug.

If you pull the cable itself (without using the handle), the internal wires may disconnect or get damaged. This may lead to electric shock or fire.

⚠ WARNING

Cooling fan

Do not touch the cooling fan while vehicle is charging. When the vehicle is switched OFF while charging, the cooling fan inside the motor compartment may automatically operate.

- Always keep the charging connector and charging plug in clean and dry condition. Be sure to keep the charging cable in a condition where there is no water or moisture.
- Make sure to use the designated charger for charging the vehicle. Using any other charger may cause failure.
- Before charging the battery, turn the vehicle OFF.

- Be careful not to drop the charging connector. The charging connector can be damaged.

AC charger

AC Charger



OCVQ011007L

AC charger cable



ONQ5EPQ011025L

You can charge your vehicle by plugging into a public charger at a charging station.

How to connect AC charger



OSG2PHQ012027L

1. Depress the brake pedal and apply the parking brake.
2. Turn OFF all switches, move the shift dial to P (Park), and turn OFF the vehicle.
3. Open the charging inlet door by pressing edge of the charging inlet door.
4. Remove any dust on the charging connector and charging inlet.
5. Hold the charging connector handle.



Then, insert the charger into the charging inlet, until you hear a click sound. If it is not fully connected, a bad connection between the charging connector and the charging terminals may cause a fire.

6. Check if the charging cable connection indicator (S) of the high voltage battery in the instrument cluster is turned ON.

Charging does not occur when the indicator is OFF. When the charging connector is not connected properly, reconnect the charging cable to charge.

*** NOTICE**

- The charging is in progress only with the shift dial is in P (Park). Charging the battery with the ENGINE START/STOP button in the ACC position is possible. However, it may discharge the 12V battery. Thus, if possible, charge the battery with the ENGINE START/STOP button in the OFF position.
- Moving the shift dial from P (Park) to R (Reverse)/N (Neutral)/D (Drive) stops the charging process. To restart the charging process, move the shift dial to P (Park), press the ENGINE START/STOP button to the OFF position, and disconnect the charging cable. Then, connect the charging cable.

Charging connector: lock mode

When the charging connector is plugged into the charging inlet, the connector lock timing varies with the modes selected by the user settings menu or the infotainment screen menu.

- Always lock: The connector locks when the charging connector is plugged into the charging inlet.
- Lock while charging: The connector locks when charging starts. The connector unlocks when charging is completed.

For more details, refer to "AC charging connector lock" on page 1-7.

Trickle charger (portable charging cable)



Trickle charger can be used if AC Charger is unavailable.

1. Plug and cable
2. Control box (ICCB)
3. Charging connector/cable

How to connect portable charger (ICCB: In-Cable Control Box)

1. Connect the plug to a household electric outlet.

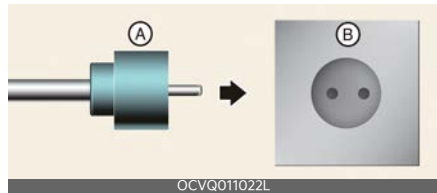

A: Plug

B: Electric Outlet

2. Check if the power lamp (green) illuminates on the control box.



3. Depress the brake pedal and apply the parking brake.
4. Turn OFF all switches, shift to P (Park), and turn OFF the vehicle. If charging is initiated without the gear in P (Park), the charging will start after the gear is automatically shifted to P (Park).
5. Open the charging door.
For more details, refer to "Fuel filler door" on page 5-35.
6. Open the protection caps of the charging connector and the charging plug. Check if there are any foreign substances or dust.
7. Hold the charging connector handle and connect it to the vehicle charging inlet. Push the connector all the way in. If the charging connector and charging terminal are not connected properly, this may cause a fire.
8. Charging starts automatically (charging lamp illuminates).



9. Check if the charging indicator light (⚡) of the high voltage battery in the instrument cluster is turned ON.

Charging is not active when the charging indicator light (⚡) is OFF. When the charging connector is not connected properly, reconnect the charging cable to charge it again.

10. After charging has started, the estimated charging time is displayed on the instrument cluster for about 1 minute.



A: Remaining Time

If you open the driver seat door while charging, the estimated charging time is also displayed on the instrument cluster for about 1 minute. When scheduled charging or scheduled air conditioner/heater is set, the estimated charging time is displayed as "-".

Charging cable storage (if equipped)



We recommend that the trickle charger cable should be put in the storage box after use.

Charging status indicator lamp for portable charger



Indicator		Details
POWER		On: Power on
CHARGE		On: Charging Blink: Current limit due to high plug temperature or high internal temperature
FAULT		Blink: Charging interrupted
CHARGE LEVEL	12	12 A
	10	10 A
	08	8 A
	06	6 A
	<p>The charging current changes whenever the button (1) is pressed for less than 1 sec with the charger plugged into an electrical outlet but not the vehicle.</p> <p style="text-align: center;">Control box</p>	

Status/Diagnosis/Countermeasure



- Charging connector plugged into vehicle (**POWER** Green ON)
- Plug connected to an electric outlet (**POWER** Green ON)

While charging



- Charge indicator (**POWER** Green ON/**CHARGE** Blue ON)
- Charging current

Before plugging charging connector into vehicle (**POWER** Green ON, **FAULT** Red blink)



- Abnormal temperature
- ICCB (In-Cable Control Box) failure

Plugged into vehicle (**POWER** Green ON, **FAULT** Red Blink)



- Diagnostic device failure
- Current leakage
- Abnormal temperature

Leakage current failure (**POWER** Green ON, **FAULT** Red Blink)



- After disconnecting and reconnecting the power plug, press and release the button for 2 seconds or longer to clear the error.

Power saving mode



- Charge level indicator is turned off if there is no status change for more than 1 minute.

How to disconnect portable charging cable (ICCB: In-Cable Control Box)

1. Before disconnecting the charging connector, make sure the doors are unlocked. When the door is locked, the charging connector lock system will not allow disconnection. To prevent charging cable theft, the charging connector cannot be disconnected from the inlet when the doors are locked. However, if the vehicle is in the charging connector AUTO mode, the charging connector automatically unlocks from the inlet when charging is completed.

*** NOTICE**

In order to disconnect the charging connector, unlock the doors to unlatch the charging connector lock system. If not, the charging connector and the vehicle's charging inlet may be damaged.

2. Hold the charging connector handle and pull it out.



3. Make sure to securely close the charging door.
4. Disconnect the plug from the household electric outlet. Do not pull the cable when disconnecting the plug.

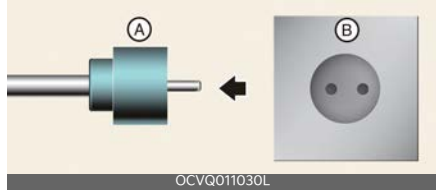

- A: Plug
- B: Electric Outlet

5. Close the protective cover for the charging connector so that foreign material cannot get into the terminal.
6. Put the charging cable inside the cable compartment to protect it.

Precautions for portable charging cable (ICCB: In-Cable Control Box)

- Use the portable charging cable that is certified by Kia.
- Do not try to repair, disassemble, or adjust the portable charging cable.
- Do not use an extension cord or adapter.
- Stop using immediately if failure warning light occurs.
- Do not touch the plug and charging connector with wet hands.
- Do not touch the terminal part of the AC charging connector and the AC charging inlet on the vehicle.
- Do not connect the charging connector to voltage that does not comply with regulations.
- Do not use the portable charging cable if it is worn out, exposed, or there exists any type of damage on the portable charging cable.
- If the ICCB case and AC charging connector is damaged, cracked, or the wires are exposed in any way, do not use the portable charging cable.

- Do not let children operate or touch the portable charging cable.
- Keep the control box free of water.
- Keep the AC charging connector or plug terminal free of foreign substances.
- Do not step on the cable or cord. Do not pull the cable or cord and do not twist or bend it.
- Do not charge when there is lightning.
- Do not drop the control box or place a heavy object on the control box.
- Do not place an object that can generate high temperatures near the charger when charging.
- Charging with the worn out or damaged household electric outlet can result in a risk of electric shock. If you are in doubt to the household electric outlet condition, have it checked by a licensed electrician.
- Stop using the portable charging cable immediately if the household electric outlet or any components is overheated or you notice burnt odors.

Actions to be taken for electric vehicle charging issues

When you cannot charge the high voltage battery after connecting the charger, check the following:

1. Check the charging settings for the vehicle.
(e.g. when scheduled charging is set, charging is not initiated immediately when the AC charger or portable charger is connected.)
2. Check the operation status of the AC charger, portable charger.
(Status of portable charger)
* Actual method for indicating the charging status may vary in accordance with the charger manufacturer.

dance with the charger manufacturer.

3. When the vehicle does not charge and a warning message appears on the instrument cluster, check the corresponding message.
4. If the vehicle is properly charged when charged with another normally working charger, contact the charger manufacturer.
5. If the vehicle does not charge when charged with another normally working charger, we recommend that you contact an authorized Kia dealer/service partner for inspection.

How to disconnect charging connector in emergency



If the charging connector does not unlock for some reason, open the hood and slightly pull the emergency cable as shown above. The charging door will then open.

If a charging door is not opened immediately with emergency cable in operation, press a charging door lightly and pull emergency cable again. The charging cable lock may not work properly when foreign materials such as dust enter the cable or the cable is encrusted with ice. In that case, the charging cable may not be disconnected or locked, or the vehicle may not be charged. If this happens, open the hood and pull the emergency cable lightly 2 to 3 times and then try to disconnect the charging cable or start recharging.

Driving the hybrid/plug-in hybrid vehicle

Starting the vehicle

Vehicles with smart key system

1. Carry the smart key or leave it inside the vehicle.
2. Make sure the parking brake is firmly applied.
3. Place the shift dial in P (Park). With the shift dial in N (Neutral), you cannot start the vehicle.
4. Depress the brake pedal.
5. Press the ENGINE START/STOP button. If the hybrid system starts, the **READY** indicator will come on.

Whether the engine is cold or warm, it should be started without depressing the accelerator.

After following the start procedures, READY indicator on the instrument cluster will turn on. For more details, please refer to "**Starting the vehicle**" on page 6-9.

Economical and safe operation of Hybrid system

- Drive smoothly. Accelerate at a moderate rate and maintain a steady cruising speed. Do not make "jackrabbit" starts. Do not race between stop-lights.
Avoid heavy traffic whenever possible. Always maintain a safe distance from other vehicles so you can avoid unnecessary braking. This also reduces brake wear out.
- The regenerative brake generates energy when the vehicle decelerates.
- When the hybrid battery power is low, the hybrid system automatically recharges the hybrid battery.

- When the engine is running with the shift dial in N (Neutral), the hybrid system cannot generate electricity. The hybrid battery cannot recharge with the shift dial in N (Neutral).

* NOTICE

In the hybrid system, the engine automatically runs and stops. When the hybrid system operates, the **READY** indicator is appeared.

In the following situation, the engine may operate automatically.

- When the engine is ready to run.
- When the hybrid battery is being charged.
- Depending on the temperature condition of the hybrid battery.

EV button



Whenever you press the EV button, Plug-in hybrid system drive mode will be changed in sequential as:

Automatic (AUTO) mode - Hybrid (CS) mode - Electric (CD) mode.

Press and hold the EV button to change to EV+ mode.

Each time the mode is changed a corresponding LED is displayed on the instrument cluster as follows.

Automatic (AUTO) mode

Type A

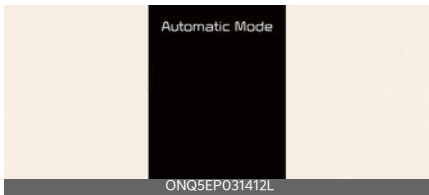

Type B



Hybrid (CS) mode

Type A

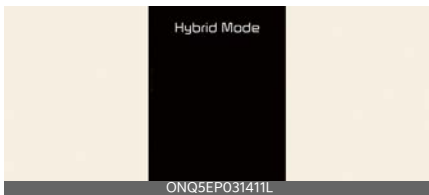

Type B

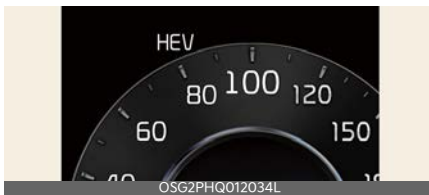

Electric (CD) mode

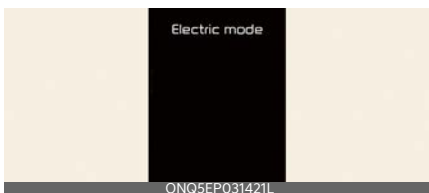

EV + mode

Type A

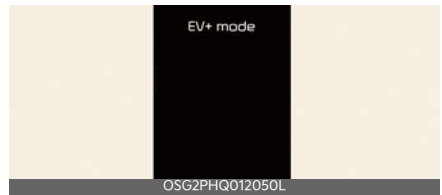

Type B



Special features

Hybrid vehicles sound different than gasoline engine vehicles. When the hybrid system operates, you may hear a sound from the hybrid battery system behind the rear seat. If you apply the accelerator pedal rapidly, you may hear an unconventional sound. When you apply the brake pedal, you may hear a sound from the regenerative brake system. When the hybrid system is turned off or on, you may hear a sound in the engine compartment. If you depress the brake pedal repeatedly when the hybrid system is turned on, you may hear a sound in the engine compartment. None of these sounds indicate a problem. These are normal characteristics of hybrid vehicles.

It is a normal condition if you hear a motor sound in the engine compartment in any of the following situations:

- The brake pedal is released after turning off the hybrid system.
- The brake pedal is applied when the hybrid system is turned off.
- When the driver door is opened.

When the hybrid system is turned ON, the gasoline engine may run or may not. In this situation, you may feel a vibration. This does not indicate a malfunction. When the **READY** indicator appears, the hybrid system is ready to begin driving. Even if the engine is off, you can operate the vehicle as long as the **READY** indicator is appeared.

* NOTICE

The hybrid system contains many electronic components. High voltage components, such as cables and other parts, may emit electromagnetic waves. Even when the electromagnetic cover blocks electromagnetic emissions, electromagnetic waves may have an effect on electronic devices. When your vehicle is not used for a long period of time, the hybrid system will discharge. You need to drive the vehicle several times a month. We recommend driving at least for 1 hour or 16 km. When the hybrid battery is discharged, or when it is impossible to jump start the vehicle, we recommend that you contact your authorized Kia dealer/partner.

⚠ WARNING

- When you start the hybrid system with the shift dial in P (Parking), the **READY** indicator appears on the instrument cluster. The driver can

drive the vehicle, even when the gasoline engine is off.

- When you leave the vehicle, you should turn OFF the hybrid system or locate the shift dial in P (Park). When you depress the accelerator pedal by mistake, or when the shift dial is not in P (Park), the vehicle will abruptly move, possibly resulting in serious injury or death.

Virtual Engine Sound System (V ESS)

Virtual Engine Sound System generates engine sound for pedestrians to hear vehicle sound because there is limited sound while motor power is used.

- If the vehicle is moving at low speed, the VESS will operate.
- When the gear is shifted to R (Reverse), an additional warning sound will be heard.

What does regenerative braking do?

It uses an electric motor when decelerating and when braking and transforms kinetic energy to electrical energy in order to charge the high voltage battery.

Battery

- The vehicle is composed of a high voltage battery that drives the motor and air conditioner, and an integrated 12V lead battery with the HEV battery that drives the lamps, wipers, and audio system.
- The integrated 12V battery is automatically charged when the vehicle is in the ready (**READY**) mode.

Hybrid system gauge

Power gauge

Type A



Type B



The hybrid system gauge indicates whether the current driving condition is fuel efficient or not.

- **CHARGE:**
Shows that the energy made by the vehicle is being converted to electrical energy. (Regenerated energy)
- **ECO:**
Shows that the vehicle is being driven in an Eco-friendly manner.
- **POWER:**
Shows that the vehicle is exceeding the Eco-friendly range.

Hybrid battery SOC (State of Charge) gauge

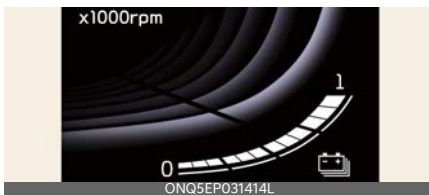

Type A



Type B



This gauge indicates the remaining hybrid battery power. If the SOC is near the "0 (Low)" level, the vehicle automatically operates the engine to charge the battery.

However, if the Service Indicator () and Malfunction Indicator Lamp (MIL) () turn on when the SOC gauge is near the "0 (Low)" level, we recommend the vehicle to be checked by an authorized Kia dealer/service partner.

Warning and indicator lights

Ready indicator READY

This indicator appears:

When the vehicle is ready to be driven.

- **ON:** Normal driving is possible.
- **OFF:** Normal driving is not possible, or a problem has occurred.
- **Blinking:** Emergency driving.

When the ready indicator goes OFF or blinks, there is a problem with the system. If this occurs, we recommend that you have your vehicle inspected by an authorized Kia dealer/service partner.

Service warning light

This warning light appears:

- When you set the ENGINE START/ STOP button to the ON position.

- The service warning light appears for approximately 3 seconds and then turns off when all checks have been performed.
- When there is a problem with the hybrid vehicle control system or hardware.

When the warning light appears while driving, or does not go OFF after starting the vehicle, we recommend that you have the vehicle inspected by an authorized Kia dealer/service partner.

EV mode indicator EV

This indicator appears:

When the vehicle is driven by the electric motor.

- "EV" indicator ON: Vehicle is driven using the electric motor or the gasoline engine is stopped.
- "EV" indicator OFF: Vehicle is driven using the gasoline engine.

Regenerative brake warning light (⚠)(red color) (⚠)(yellow color)

This warning light appears:

When the regenerative brake does not operate and the brake does not perform well. This causes the brake warning light (red) and regenerative brake warning light (yellow) to appear simultaneously. If this occurs, drive safely and have your vehicle inspected by an authorized Kia dealer/service partner. The operation of the brake pedal may be more difficult than normal and the braking distance may increase.

Charging cable connection indicator (⚡) (Plug-in hybrid vehicle)

This indicator appears in red when the charging cable is connected.

LCD display messages

Ready to drive



A: Ready to start driving

This message is displayed when the vehicle is ready to be driven.

Check regenerative brakes

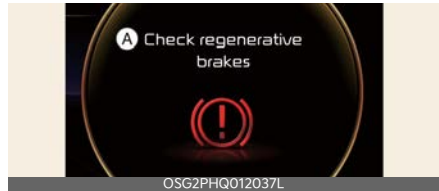

A: Check regenerative brakes

This message is displayed when the brake performance is low or the regenerative brake does not work properly due to a failure in the brake system. If this occurs, it may take longer for the brake pedal to operate and the braking distance may become longer.

Stop vehicle and check regenerative brakes



A: Stop vehicle and check brakes

This message is displayed when a failure occurs in the brake system.

If this occurs, park the vehicle in a safe location and we recommend that you tow your vehicle to the nearest authorized Kia dealer/service partner and have the vehicle inspected.

Check Hybrid system

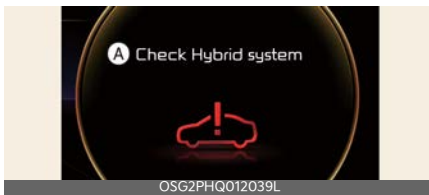

A: Check Hybrid system

This message is displayed when there is a problem with the hybrid control system. Refrain from driving when the warning message is displayed.

If this occurs, we recommend that you have the vehicle inspected by an authorized Kia dealer/service partner.

Check Hybrid system. Stop safely



A: Stop safely and check Hybrid system

This message is displayed when there is a problem with the hybrid control system. The **READY** indicator will blink and a warning chime will sound until the problem is solved. Refrain from driving when the warning message is displayed.

If this occurs, we recommend that you have the vehicle inspected by an authorized Kia dealer/service partner.

Check Hybrid system. Do not start engine

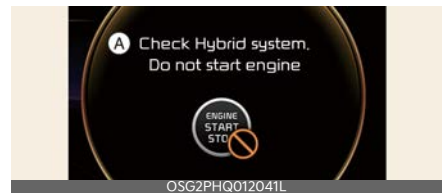

A: Check Hybrid system. Do not start engine

This message is displayed when the hybrid battery power (SOC) level is low. A warning chime will sound until the problem is solved. Refrain from driving when the warning message is displayed.

If this occurs, we recommend that you have the vehicle inspected by an authorized Kia dealer/service partner.

Stop vehicle and check power supply



A: Stop safely and check power supply

This message is displayed when a failure occurs in the power supply system. If this occurs, park the vehicle in a safe location and tow your vehicle to the nearest authorized Kia dealer/service partner and have the vehicle inspected.

Check Virtual Engine Sound System



A: Check virtual engine sound system

This message is displayed when there is a problem with the Virtual Engine Sound System (VESS).

If this occurs, we recommend that you have the vehicle inspected by an authorized Kia dealer/service partner.

Refill inverter coolant



A: Refill inverter coolant

This message is displayed when the inverter coolant is nearly empty. You should refill the inverter coolant.

Park with engine On to charge battery

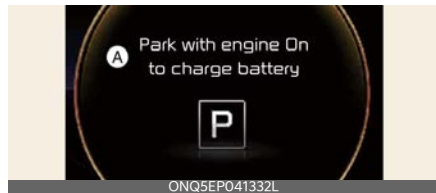

A: Park with engine On to charge battery

This message is displayed when the hybrid battery power (SOC) level is low. If this occurs, park the vehicle in a safe location and wait until the hybrid battery is charged.

Start engine to avoid battery discharge

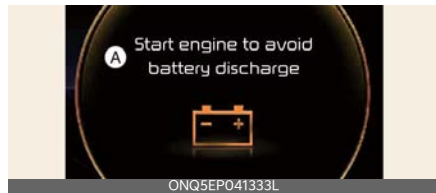

A: Start engine to avoid battery discharge

This message is displayed to inform the driver the 12V battery may be discharged if the ENGINE START/STOP button is in ON position (without the **READY** indicator ON).

Set the vehicle to the ready (**READY**) mode to prevent the 12V battery from being discharged.

CD (Charge Depleting, Electric) mode (Plug-in hybrid vehicle)



A: Electric Mode

The high-voltage (hybrid) battery is used to drive the vehicle.

EV+ (Electric +) mode (Plug-in hybrid vehicle)



A: EV + Mode

The high-voltage (hybrid) battery is only used to drive the vehicle. (Except completely depressing the accelerator pedal)

AUTO (Automatic) mode (Plug-in hybrid vehicle)



A: Automatic mode

The drive mode will be automatically selected from either Electric (CD) mode or Hybrid (CS) mode by the system according to the driving condition.

CS (Charge Sustaining, Hybrid) mode (Plug-in hybrid vehicle)

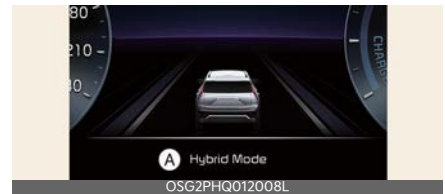

A: Hybrid mode

The high-voltage (hybrid) battery and gasoline engine is used to drive the vehicle.

Remaining charge time (Plug-in hybrid vehicle)

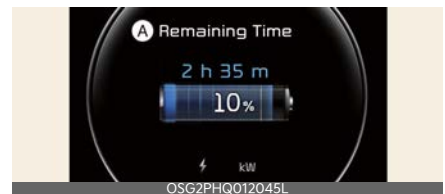

A: Remaining Time

The message is displayed to notify the remaining time to fully charge the battery.

Charging stopped. Check the AC charger (Plug-in hybrid vehicle)

This message is displayed when the charging failed by external charger error.

The purpose of this message is to let you know the error has occurred in the charger itself, not in the vehicle.

Charging stopped. Check the cable connection (Plug-in hybrid vehicle)

This message is displayed when charging is stopped because the charging connector is not correctly connected to the charging inlet. If this occurs, separate the charging connector and reconnect it and check whether there is any problem (external damage, foreign substances, etc.) with the charging connector and charging inlet. If the same problem occurs when charging the vehicle with a replaced charging cable or genuine Kia portable charger, have the vehicle inspected by a professional workshop. Kia recommends to visit an authorized Kia dealer/service partner.

Low/High System Temp. Maintaining Hybrid mode (Plug-in hybrid vehicle)

This message is displayed when the temperature of the high-voltage (hybrid) battery is too low or too high.

This warning message is to protect the battery and the hybrid system.

Low/High System Temp. Switching to Hybrid mode (Plug-in hybrid vehicle)

This message is displayed when the temperature of the high-voltage (hybrid) battery is too low or high. This warning message is to protect the battery and the hybrid system.

Switching to Hybrid mode to allow heating (Plug-in hybrid vehicle)

- When the outdoor temperature is lower than $-13\text{ }^{\circ}\text{C}$ ($9\text{ }^{\circ}\text{F}$) and the coolant temperature is lower than $40\text{ }^{\circ}\text{C}$ ($104\text{ }^{\circ}\text{F}$), you turn the climate control On for heating, the above message will be displayed in the cluster. Then, the vehicle will automatically switch to HEV mode and EV mode will not be activated (although EV/HEV button is pressed)
- When the outdoor temperature is higher than $-10\text{ }^{\circ}\text{C}$ ($14\text{ }^{\circ}\text{F}$), or the coolant temperature is higher than $80\text{ }^{\circ}\text{C}$ ($176\text{ }^{\circ}\text{F}$) or you turn the climate control Off, the vehicle will automatically return to EV mode.
- If high-voltage PTC is equipped in the vehicle, the vehicle will not switch to hybrid mode to allow heating.

Wait until fuel door unlocks (Plug-in hybrid vehicle)

The message is displayed when you attempt to unlock the fuel filler door with the fuel tank pressurized. Wait until the fuel tank is depressurized.

* NOTICE

- It may take up to 20 seconds to unlock fuel filler door.
- If the fuel filler door does not open because ice has formed around it, tap lightly or push on the door to break the ice and release the door.
- Do not pry on the door. If necessary, spray around the door with an approved de-icer fluid (do not use radiator anti-freeze) or move the vehicle to a warm place and allow the ice to melt.

Fuel door unlocked (Plug-in hybrid vehicle)

This message is displayed when the fuel filler door is unlocked.

Also means "Ready to refuel".

Please press the rear center edge of fuel filler door to open.

Check fuel door (Plug-in hybrid vehicle)

This message is displayed when the fuel filler door is open while driving or an abnormality has occurred.

Charging door open (Plug-in hybrid vehicle)

This message indicates that the charging door is open while in driving ready state to encourage you to inspect and close the door.

(Driving with the charging door open may result in moisture inflow or damage. This message is used to prevent such occurrences.)

Unplug vehicle to start (Plug-in hybrid vehicle)

The message is displayed when you start the engine without unplugging the charging cable. Unplug the charging cable, and then start the vehicle.

Maintaining Hybrid mode to continue heating (Plug-in hybrid vehicle)

A message is displayed when heating is in operation and the HEV mode is maintained to meet the heating operating conditions when attempting to switch to EV mode by pressing the EV/HEV button.

EV modes (Plug-in hybrid vehicle)

A corresponding message is displayed when a mode is selected by pressing the EV button.

PHEV infotainment system (Plug-in hybrid vehicle)

Press [PHEV] on the [Home screen].

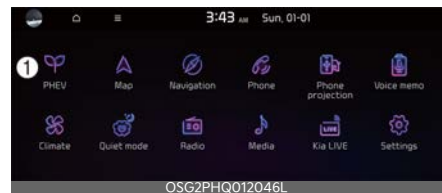

1 PHEV

The Plug-in Hybrid menu consists of five sections: [EV range], [Energy informa-

tion], [Charge management], [ECO driving], [Energy flow].



- 1 EV range
- 2 Energy information
- 3 Charge management
- 4 ECO driving
- 5 Energy flow

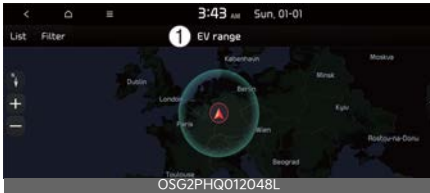

- 1 EV range

*** INFORMATION**

The infotainment system may change after software updates. For more information, refer to the manual provided in the infotainment system and the quick reference guide.

Energy flow

The hybrid system informs the drivers its energy flow in various operating modes. While driving, the current energy flow is specified in 11 modes.

Vehicle stop



A: Idle Mode

The vehicle is stopped.
(No energy flow)

EV propulsion



A: Electric Mode

Only the motor power is used to drive the vehicle.
(Battery → Wheel)

Power assist



A: Hybrid Mode

Both the motor and the engine power are used to drive the vehicle.
(Battery & Engine → Wheel)

Engine only propulsion



A: Engine Mode

Only the engine power is used to drive the vehicle.
(Engine → Wheel)

Engine brake



A: Engine Braking

The engine braking is used to decelerate the vehicle.
(Wheel → Engine)

Engine generation



A: Charging

When the vehicle is stopped, the high-voltage battery is charged up by the engine.
(Engine → Battery)

Power reserve



A: Charging

The engine is simultaneously used to drive the vehicle and to charge up the high-voltage battery.
(Engine → Wheel & Battery)

Regeneration



A: Charging

The high-voltage battery is charged up by the regenerative brake system.
(Wheel → Battery)

Engine generation/motor drive

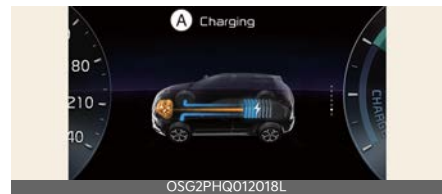

A: Charging

The engine charges up the high-voltage battery. The motor power is used to drive the vehicle.
(Engine → Battery → Wheel)

Engine generation/regeneration



A: Charging

The engine and regenerative brake system charges up the high-voltage battery. (Engine & Wheel → Battery)

Engine brake/regeneration



A: Charging

The engine braking is simultaneously used to decelerate the vehicle and to charge up the high-voltage battery. (Wheel → Engine & Battery)

Start engine to avoid battery discharge

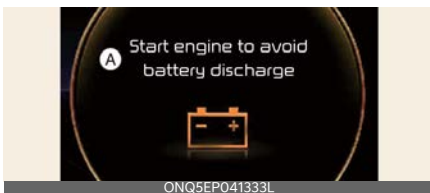

A: Start engine to avoid battery discharge

If the engine is not turned on with the ENGINE START/STOP button in ACC or ON for a while, the battery can be dis-

charged. Please turn on the engine to prevent 12V battery from discharge.

Aux. Battery Saver+

The Aux. Battery Saver+ is a function that monitors the charging status of the 12V auxiliary battery. If the auxiliary battery level is low, the main high voltage battery charges the auxiliary battery.

* NOTICE

The Aux. Battery Saver+ function will be ON when the vehicle is delivered.

Mode

- Cycle Mode: When the vehicle is OFF with all doors, hood and tailgate closed, the Aux. Battery Saver+ periodically activates according to the auxiliary battery status.
- Automatic Mode: When the ENGINE START/STOP button is in the ON position with the charging connector plugged in, the function activates according to the auxiliary battery status to prevent over-discharge of the auxiliary battery.

⚠ CAUTION

- The Aux. Battery Saver+ activates for a maximum of 20 minutes. If the Aux. Battery Saver+ function activates more than 10 times consecutively, in the Automatic Mode the function will stop activating, judging that there is a problem with the auxiliary battery. In this case, drive the vehicle for some period of time. The function will start activating if the auxiliary battery returns to normal.
- The Aux. Battery Saver+ function cannot prevent battery discharge if the auxiliary battery is damaged, worn

out, used as a power supply or unauthorized electronic devices are used.

System setting

The driver can activate the Aux. Battery Saver+ function by placing the ENGINE START/STOP button to the ON position.

WARNING

When the function is activating the charging indicator lamp will quickly blink and high voltage electricity will be flowing in the vehicle. Do not touch the high voltage electric wire (orange), connector, and all electric components and devices. This may cause electric shock and lead to injuries. Also, do not modify your vehicle in any way. This may affect your vehicle performance and lead to an accident.

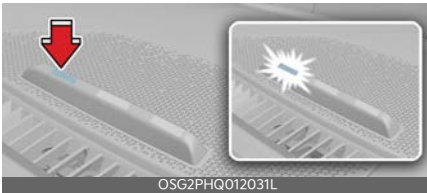

Components of the hybrid/plug-in hybrid vehicle

Plug-in hybrid vehicle components

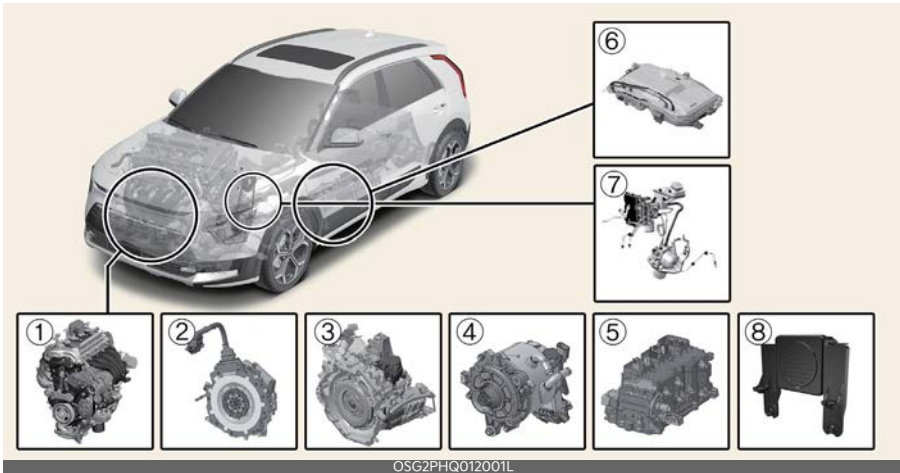

* The actual shape may differ from the illustration.

- 1 Engine: 1.6L
- 2 Motor: 32 kW (HEV) / 62 kW (PHEV)
- 3 Transmission: 6DCT
- 4 Hybrid starter generator (HSG)
- 5 HPCU (Hybrid Power Control Unit)
- 6 High voltage battery system
- 7 Regenerative brake system
- 8 Virtual Engine Sound System (VESS)

The Hybrid battery uses high voltage to operate the electric motor and other components. High voltage is dangerous if touched.

Your vehicle is equipped with orange colored insulation and covers over the high voltage components to protect people from electric shock. High voltage warning labels are attached to some system components as additional warnings. Have your vehicle serviced by a professional workshop. Kia recommends to visit an authorized Kia dealer/service partner.

HPCU (Hybrid Power Control Unit) *1

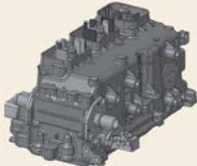

OSG2HQ011019

High voltage battery system *2



OSG2PHQ012053L

* 1: Located in the engine compartment

* 2: Located underfloor

⚠ WARNING

Never touch orange colored or high voltage labeled components, including wires, cables, and connections. When the insulators or covers are damaged or removed, severe injury or death from electrocution may occur.

⚠ WARNING

While replacing the fuses in the engine compartment, never touch the HPCU. The HPCU carries high voltage. Touching the HPCU may result in electrocution, serious injury, or death.

⚠ WARNING

In the hybrid system, the hybrid battery uses high voltage to operate the motor and other components. This high voltage hybrid battery system can be very dangerous.

Never touch the hybrid system. When you touch the hybrid battery system, serious injury or death may occur.

⚠ CAUTION

- Do not pile up any items in an area behind the high voltage battery. In a crash, the battery may become unstable, or its performance may degrade.
- Do not apply strong force or pile up any items above the luggage compartment. Such an attempt may distort the high voltage battery case, causing a safety problem or degrading the performance.
- Be careful when loading flammable liquid in the passenger compartment. It could cause operational and safety degradation if the liquid leaks and flows in the high voltage battery.

Drive motor *3



* 3: Located in the engine compartment

⚠ WARNING

As with all batteries, avoid fluid contact with the hybrid battery. If the battery is damaged and if electrolyte comes in contact with your body, clothes or eyes, immediately flush with a large quantity of fresh water.

⚠ WARNING

Do not use an after-market battery charger to charge the hybrid battery. Doing so may result in death or serious injury.

⚠ WARNING

High waters

- Avoid high waters as this may result in your vehicle becoming saturated with water and could compromise the high voltage components.
- Do not touch the any of the high voltage components within your vehicle if your vehicle has been submerged in water equal to half of the vehicle height. Touching high voltage components once submerged in water could result in severe burns or electric shock that could result in death or serious injury.

⚠ WARNING

Carrying liquids in tailgate

Do not load large amounts of water in open containers into the vehicle. If the water spills onto the HEV battery, it may cause a short and damage the battery.

⚠ CAUTION

Cleaning engine

When you clean the engine compartment, do not wash using water. Water may cause electric arcing to occur and damage electronic parts and components.

⚠ WARNING

Exposure to high voltage

- High voltage in the hybrid battery system is very dangerous and can cause severe burns and electric shock. This may result in serious injury or death.
- For your safety, never touch, replace, dismantle or remove any portion of the hybrid battery system including components, cables and connectors.

⚠ WARNING

Use of water or liquids

If water or liquids come into contact with the hybrid system components, and you are also in contact with the water, severe injury or death due to electrocution may occur.

⚠ WARNING

Hot components

When the hybrid battery system operates, the HEV battery system can be hot. Heat burns may result from touching even insulated components of the HEV system.

⚠ CAUTION

Prolonged parking

Prolonged parking might cause battery discharge and operation failure due to natural discharge. Driving the vehicle approximately once every 2 months, more than 15 km (9 miles) is recommended. The battery will be charged automatically when driving the vehicle.

Hybrid vehicle components

High voltage battery system

HPCU (Hybrid Power Control Unit) *1

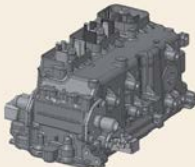

OSG2HQ011019

High voltage battery system *2



OSG2HQ011018

* 1: Located in the engine compartment

* 2: Located under the 2nd row seats

⚠ WARNING

Never touch orange colored or high voltage labeled components, including wires, cables, and connections. When the insulators or covers are damaged or removed, severe injury or death from electrocution may occur.

⚠ WARNING

While replacing the fuses in the engine compartment, never touch the HPCU. The HPCU carries high voltage. Touching the HPCU may result in electrocution, serious injury, or death.

⚠ WARNING

In the hybrid system, the hybrid battery uses high voltage to operate the motor and other components. This high voltage hybrid battery system can be very dangerous.

Never touch the hybrid system. When you touch the hybrid battery system, serious injury or death may occur.

⚠ CAUTION

- Do not pile up any items in an area behind the high voltage battery. In a crash, the battery may become unstable, or its performance may degrade.
- Do not apply strong force nor pile up any items above the luggage compartment. Such an attempt may distort the high voltage battery case, causing a safety problem or degrading the performance.
- Be careful when loading flammable liquid in the luggage compartment. It could cause operational and safety

degradation if the liquid leaks and flows in the high voltage battery.

Drive motor *3



* 3: Located in the engine compartment

⚠ WARNING

- Do not disassemble the high voltage motor connector. The high voltage motor connector may contain residual high voltage. Coming in contact with high voltage may result in death or serious injury.
- Your vehicle's hybrid system should only be inspected or repaired by an authorized Kia dealer/service partner.

⚠ WARNING

- Do not disassemble or assemble the high voltage battery system. Doing so may result in electric shock, causing death or serious injury.
- If you disassemble or assemble hybrid system components improperly, it may damage the performance and reliability of your vehicle.
- If electrolyte comes in contact with your body, clothes or eyes, immediately flush with a large quantity of fresh tap water. Have your eyes examined by a doctor as soon as possible.

⚠ WARNING

Never assemble or disassemble the high voltage battery system.

- If you assemble or disassemble the high voltage battery system, the durability and performance of the vehicle may be damaged.
- When you want to check the high voltage battery system, we recommend that you contact your authorized Kia dealer/service partner.
- Do not touch the high voltage battery and high voltage cable connected to motor (orange color). Severe burns and electric shock may occur. For your safety, do not touch the cover of electronic components and electronic cable. Do not remove the cover of electronic components and electronic cable. In particular, never touch the high voltage battery system when the hybrid system in operation. It may result in death or serious injury.

⚠ WARNING

- Never use the package modules (high voltage battery, inverter and converter) for any other purpose.
- Do not use an unauthorized battery charger to charge the high voltage battery. Doing so may result in death or serious injury.
- Never locate the high voltage system near or in a fire.
- Never drill into or strike the package module. Otherwise, it may be damaged. An electric shock may occur, resulting in serious injury or death.

*** NOTICE**

- When the vehicle is paint baked, do not bake over 30 minutes in 70°C (158°F) or 20 minutes in 80°C (176°F) degree.
- Do not wash the engine compartment, using water. Water may cause an electric shock and damage the electronic components.

⚠ WARNING

This hybrid vehicle uses the hybrid battery system inverter and converter to generate high voltage. High voltage in the hybrid battery system is very dangerous and may cause severe burns and electric shock. This may result in serious injury or death.

- For your safety, never touch, replace, disassemble or remove the hybrid battery system including components, cables and connectors. Severe burns or electric shock may result in serious injury or death when you fail to follow this warning.
- When the hybrid battery system operates, the hybrid battery system can be hot. Always be careful because burns or electric shock may be caused by high voltage.
- Do not spill liquid on the HPCU, HSG, motor and fuses. If the hybrid system components come in contact with liquid, it may result in electric shock.

Hybrid battery cooling duct (Hybrid vehicle)

Under the rear seats



The hybrid battery cooling duct is located under the rear seats. The cooling duct cools down the hybrid battery. When the hybrid battery cooling duct is blocked, the hybrid battery may be overheated.

Clean the cooling duct for the hybrid battery with a dry cloth on a regular basis.

⚠ WARNING

- Never clean the cooling duct of the hybrid battery with a wet cloth. If any water enters the cooling duct of the hybrid battery, the hybrid battery may cause an electric shock, resulting in a serious damage, an injury or a death.
- The hybrid battery is composed of lithium-ion polymer. If the hybrid battery is improperly handled, it is dangerous to the environment. Also it may cause electrical shock and severe burns, resulting in a serious injury or a death.
- Do not spill liquid over the cooling duct of the hybrid battery. Doing so is very dangerous. It may cause electric shock or serious injury.
- Do not cover the cooling duct with objects.
- Do not put any objects into the cooling duct of the hybrid battery. Doing so may cause loss of cooling duct vol-

ume to the hybrid battery. When the cooling duct is blocked with any objects, immediately contact your Kia dealer/partner.

- Never place a container of liquid on or near the cooling duct. If the liquid spills, the hybrid battery located in the luggage compartment may be damaged.
- Secure all loads in the luggage compartment to prevent them from being tossed about before driving. When a sharp or heavy load strike with a strong impact or pierce the interior luggage compartment wall, the hybrid battery system may be damaged, deteriorating its performance.
- Do not obstruct the cooling duct with any other objects.

High voltage service interlock connector

⚠ DANGER

Hybrid

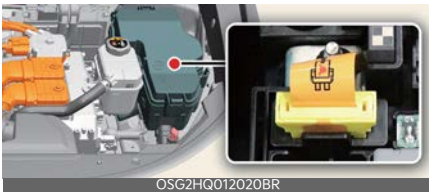

Plug-in Hybrid



In case of emergency, pull down the yellow lever in the service interlock connector to isolate the high voltage of the

battery. Service interlock connector is not completely removed.

⚠ WARNING

Never disconnect the service interlock connector except in an emergency situation. Serious problems may occur, such as the vehicle will not start.

If an accident occurs

⚠ WARNING

- For your safety, do not touch the high voltage cables, connectors and package modules. High voltage components are orange in color.
- Exposed cables or wires may be visible inside or outside of the vehicle. Never touch the wires or cables, because an electrical shock, an injury, or a death may occur.
- Any gas or electrolyte leakage from your vehicle is not only poisonous but also flammable. Upon witnessing one of those, open the windows, and remain a safe distance from the vehicle out of the road.

Immediately call an emergency services or contact an authorized Kia dealer and advise them that a hybrid vehicle is involved.

- When the vehicle is severely damaged, remain a safe distance of 15 meter or more between your vehicle and other vehicles/ flammables.

⚠ WARNING

If a fire occurs:

- If a small scale fire occurs, use a fire extinguisher (ABC, BC) that is meant for electrical fires.

If it is impossible to extinguish the fire in the early stage, remain a safe distance from the vehicle and immediately call your local fire emergency responders. Also, advise them that a hybrid vehicle is involved.

If the fire spreads to the high voltage battery, large amount of water is needed to put out the fire.

Using small amount of water or fire extinguishers not meant for electrical fires could cause serious injury or death from electrical shocks.

- Upon witnessing any sparks, gases, flames, or fuel leakage of your vehicle, immediately call emergency services or contact an authorized Kia dealer/partner. Also, advise them that a hybrid vehicle is involved.

WARNING

When a submersion in water occurs:

When your vehicle is flooded in water, a high-voltage battery may cause shock or fires. Thus, turn the hybrid system OFF, take the key in your possession and escape to a safe place. Never attempt physical contact with your flooded vehicle.

Immediately contact an authorized Kia dealer and advise them that a hybrid vehicle is involved.

When the hybrid vehicle shuts off

When the high voltage battery or 12 volt battery is discharged, or when the fuel tank is empty, the hybrid system may not operate while driving. When the Hybrid system does not operate, do the followings:

1. Gradually reduce the vehicle speed. Pull over your vehicle off the road in a safe area.
2. Locate the shift dial in P (Park).
3. Turn ON the hazard warning flashers.
4. Turn OFF the vehicle, and try to start the hybrid system again, while depressing the brake pedal and turning on the ENGINE START/STOP button.
5. When the hybrid system still does not operate, refer to "Emergency starting" on page 7-5.

Before jump-starting the vehicle, check the fuel level and the exact procedure to jump start. When the fuel level is low, do not attempt to drive the vehicle only with the battery power. The high voltage battery may be discharged, and the hybrid system will turn OFF.

WARNING

Accident Vehicle

Never touch electric wires or cable. If exposed electric wires or cables are visible inside or outside of your vehicle, an electric shock may occur.

WARNING

Putting out fire

Never use a small quantity of water to put out a fire in your vehicle because it could cause serious injuries or death from electrical shocks. If a fire occurs, evacuate the car immediately and contact the fire department.

Fuel requirements	2-2
Vehicle modifications.....	2-4
Vehicle handling instructions	2-4
HEV/PHEV powertrain	2-5
Vehicle break-in process	2-5
Risk of burns when parking or stopping vehicle	2-6
Open Source Software Notice	2-6

Introduction

Fuel requirements

Unleaded gasoline

For Europe

For the optimal vehicle performance, we recommend you to use unleaded gasoline with an octane rating of RON (Research Octane Number) 95/AKI (Anti Knock Index) 91 or higher.

You may use unleaded gasoline with an octane rating of RON 91~94/AKI 87~90 but it may result in slight performance reduction of the vehicle. (Do not use methanol blended fuels.)

Except Europe

Your new Kia vehicle is designed to use only unleaded fuel having an Octane Rating of RON (Research Octane Number) 91/AKI (Anti- Knock Index) 87 or higher. (Do not use methanol blended fuels.)

Your new vehicle is designed to obtain maximum performance with unleaded fuel, as well as minimize exhaust emissions and spark plug fouling.

WARNING

- Do not "top off" after the nozzle automatically shuts off when refueling.
- Always check that the fuel cap is installed securely to prevent fuel spillage in the event of an accident.

CAUTION

Never use leaded fuel. The use of leaded fuel is detrimental to the catalytic converter and will damage the engine con-

trol system's oxygen sensor and affect emission control.

Never add any fuel system cleaning agents to the fuel tank other than what has been specified. Kia recommends to consult an authorized Kia dealer/service partner for details.

Gasoline containing alcohol and methanol

Gasohol, a mixture of gasoline and ethanol (also known as grain alcohol), and gasoline or gasohol containing methanol (also known as wood alcohol) are being marketed along with or instead of unleaded gasoline.

Do not use gasohol containing more than 10% ethanol, and do not use gasoline or gasohol containing any methanol. Either of these fuels may cause drivability problems and damage to the fuel system, engine control system and emission control system.

Discontinue using gasohol of any kind if drivability problems occur.

Vehicle damage or drivability problems may not be covered by the manufacturer's warranty if they result from the use of:

1. Gasohol containing more than 10% ethanol.
2. Gasoline or gasohol containing methanol.
3. Leaded fuel or leaded gasohol.

CAUTION

Never use gasohol which contains methanol. Discontinue use of any gasohol product which impairs drivability.

Other fuels

Using fuels such as

- Silicone (Si) contained fuel,
- MMT (Methylcyclopentadienyl Manganese Tricarbonyl), Manganese (Mn) contained fuel,
- Ferrocene (Fe) contained fuel, and
- Other metallic additives contained fuels,

may cause vehicle and engine damage or cause plugging, misfiring, poor acceleration, engine stalling, catalyst melting, abnormal corrosion, life cycle reduction, etc.

Also, the Malfunction Indicator Lamp (MIL) may appear.

* NOTICE

Damage to the fuel system or performance problem caused by the use of these fuels may not be covered by your New Vehicle Limited Warranty.

Use of MTBE

Kia recommends avoiding fuels containing MTBE (Methyl Tertiary Butyl Ether) over 15.0% vol. (Oxygen Content 2.7% weight) in your vehicle.

Fuel containing MTBE over 15.0% vol. (Oxygen Content 2.7% weight) may reduce vehicle performance and produce vapor lock or hard starting.

⚠ CAUTION

Your New Vehicle Limited Warranty may not cover damage to the fuel system and any performance problems that are caused by the use of fuels containing methanol or fuels containing MTBE (Methyl Tertiary Butyl Ether) over 15.0% vol. (Oxygen Content 2.7% weight.)

Do not use methanol

Fuels containing methanol (wood alcohol) should not be used in your vehicle. This type of fuel can reduce vehicle performance and damage components of the fuel system, engine control system and emission control system.

Fuel additives

Kia recommends that you use unleaded gasoline which has an octane rating of RON (Research Octane Number) 95/AKI (Anti Knock Index) 91 or higher (for Europe) or Octane Rating of RON (Research Octane Number) 91/AKI (Anti-Knock Index) 87 or higher (except Europe).

For customers who do not use good quality gasolines including fuel additives regularly, and have problems starting or the engine does not run smoothly, one bottle of additives should be added to the fuel tank when the engine oil is replaced.

Additives are available from a professional workshop along with information on how to use them. Kia recommends to visit an authorized Kia dealer/service partner.

Operation in foreign countries

If you are going to drive your vehicle in another country, be sure to:

- Observe all regulations regarding registration and insurance.
- Determine that acceptable fuel is available.

Vehicle modifications

This vehicle should not be modified. Modification of your vehicle could affect its performance, safety or durability and may even violate governmental safety and emissions regulations.

* NOTICE

Damage or performance problems resulting from any modification may not be covered under warranty.

⚠ CAUTION

If you use unauthorized electronic devices, it may cause the vehicle to operate abnormally, wire damage, battery discharge and fire. For your safety, do not use unauthorized electronic devices.

Vehicle handling instructions

As with other vehicles of this type, failure to operate this vehicle correctly may result in loss of control, an accident or vehicle rollover.

Specific design characteristics (higher ground clearance, track, etc.) give this vehicle a higher center of gravity than other types of vehicles. In other words they are not designed for cornering at the same speeds as conventional 2-wheel drive vehicles.

Avoid sharp turns or abrupt maneuvers. Again, failure to operate this vehicle correctly may result in loss of control, an accident or vehicle rollover.

Be sure to read the "Reducing the risk of a rollover" on page 6-173.

HEV/PHEV powertrain

By following a few simple precautions for the first 6,000 km (4,000 miles) you may increase the performance economy and life of your vehicle.

- Do not race the engine.
- Avoid hard stops, except in emergencies, to allow the brakes to seat properly.

Vehicle break-in process

By following a few simple precautions for the first 1,000 km (600 miles) you may increase the performance, economy and life of your vehicle.

- Do not race the engine.
- While driving, keep your engine speed (rpm, or revolutions per minute) within 3,000 rpm.
- Do not maintain a single speed for long periods of time, either fast or slow. Varying engine speed is needed to properly break-in the engine.
- Avoid hard stops, except in emergencies, to allow the brakes to seat properly.
- Don't tow a trailer during the first 2,000 km (1,200 miles) of operation.
- Fuel economy and engine performance may vary depending on vehicle break-in process and be stabilized after 6,000 km (4,000 miles). New engines may consume more oil during the vehicle break-in period.

Risk of burns when parking or stopping vehicle

WARNING

- Do not park or stop the vehicle near flammable items such as leaves, paper, oil, and tire. Such items placed near the exhaust system can become a fire hazard.
 - When an engine idles at a high speed with the rear side of the vehicle touching the wall, heat of the exhaust gas can cause discoloration or fire. Keep enough space between the rear part of the vehicle and the wall.
 - Be sure not to touch the exhaust/catalytic systems while engine is running or right after the engine is turned off. There is a risk of burns since the systems are extremely hot.
-

Open Source Software Notice

This vehicle contains software with open source licenses.

Open source software information including the source code, copyright notices and referred license terms may be obtained on the website

<http://worldwide.kia.com/int/opensource>

Kia Corporation will provide the open source code to you in storage medium such as CD-ROM for minimum charge covering the cost of performing source distribution upon email request to opensource@kia.com within a period of 3 years from the date of product purchase.

Your vehicle at a glance **3**

Exterior overview	3-2
Interior overview	3-5
Instrument panel overview	3-8
Engine compartment.....	3-11

Your vehicle at a glance

Exterior overview

Front view



OSG2PH012001L

* The actual features in your vehicle may not necessarily be available due to the selected options or regions.

- 1. Hood 5-33
- 2. Head lamp 5-73, 8-58, 8-60
- 3. Wheel and tire 8-37, 9-5
- 4. Outside rear view mirror 5-46
- 5. Sunroof 5-39
- 6. Front windshield wiper blades 5-78, 8-32
- 7. Windows 5-28
- 8. Front ultrasonic sensor 6-143, 6-155
- 9. Front radar 6-53, 6-102, 6-155
- 10. Front view camera 6-44

11. Front fog lamp	8-58
12. Roof rack	5-107
13. Charging door	1-4

Rear view



* The actual features in your vehicle may not necessarily be available due to the selected options or regions.

1. Doors	5-12
2. Fuel filler door	5-35
3. Rear combination lamp	8-59
4. High mounted stop lamp	8-59
5. Tailgate	5-20
6. Antenna	5-109
7. Wide-rear view camera	6-128, 6-148
8. Rear ultrasonic sensor	6-140
9. Rear wiper	5-78, 8-32

10.Backup lamp and rear fog lamp

8-59

Interior overview

Left-hand drive



3

Right-hand drive



* The actual features in your vehicle may not necessarily be available due to the selected options or regions.

- | | |
|--|------------|
| 1. Inside door handle | 5-14 |
| 2. Seat position memory system | 5-18 |
| 3. Outside rearview mirror folding switch | 5-46 |
| 4. Outside rearview mirror control switch | 5-46 |
| 5. Central door lock/unlock switch | 5-14 |
| 6. Power window switches (Front) | 5-30 |
| 7. Power window switches (Rear) | 5-30 |
| 8. Power window lock button/Electronic child lock button | 5-16, 5-31 |
| 9. Steering wheel tilt/telescopic lever | 5-42 |
| 10. Steering wheel | 5-42 |
| 11. Headlight leveling adjustment switch | 5-78 |
| 12. Tailgate unlock button | 5-20 |
| 13. 12V battery reset button | 7-5 |

14.ESC OFF button	6-37
15.Hood release lever	5-33
16.Instrument panel fuse	8-45
17.Seat	4-3
18.Shift dial	6-15
19.Brake pedal	6-31
20.Fuel door open	5-35
21.Charging deactivation button	1-7

Instrument panel overview

Left-hand drive

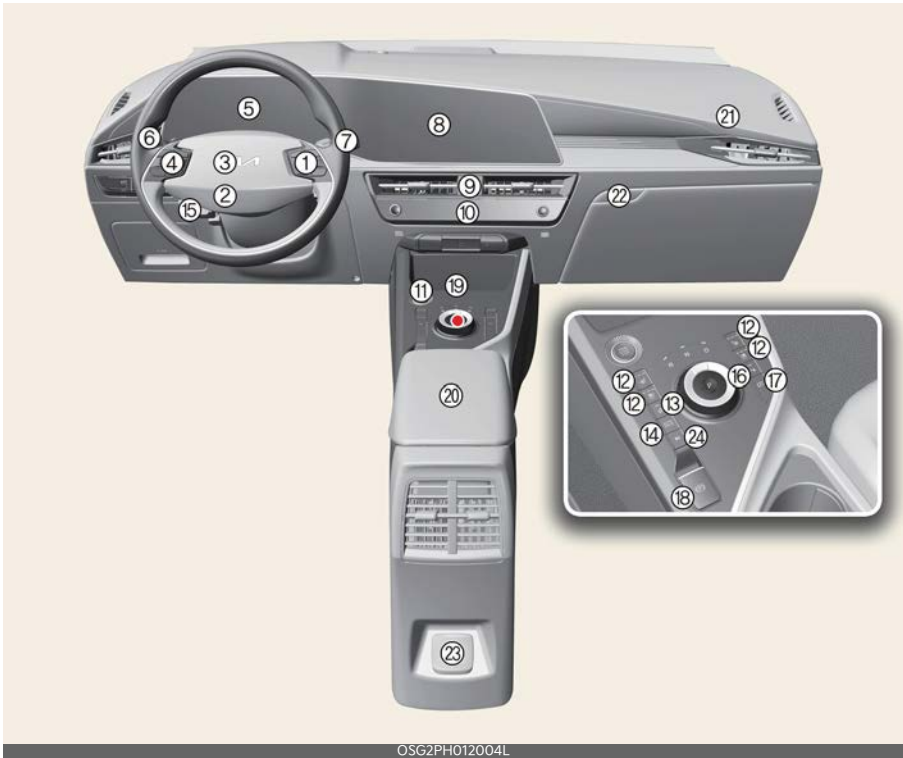

OSG2PH012004L

Right-hand drive

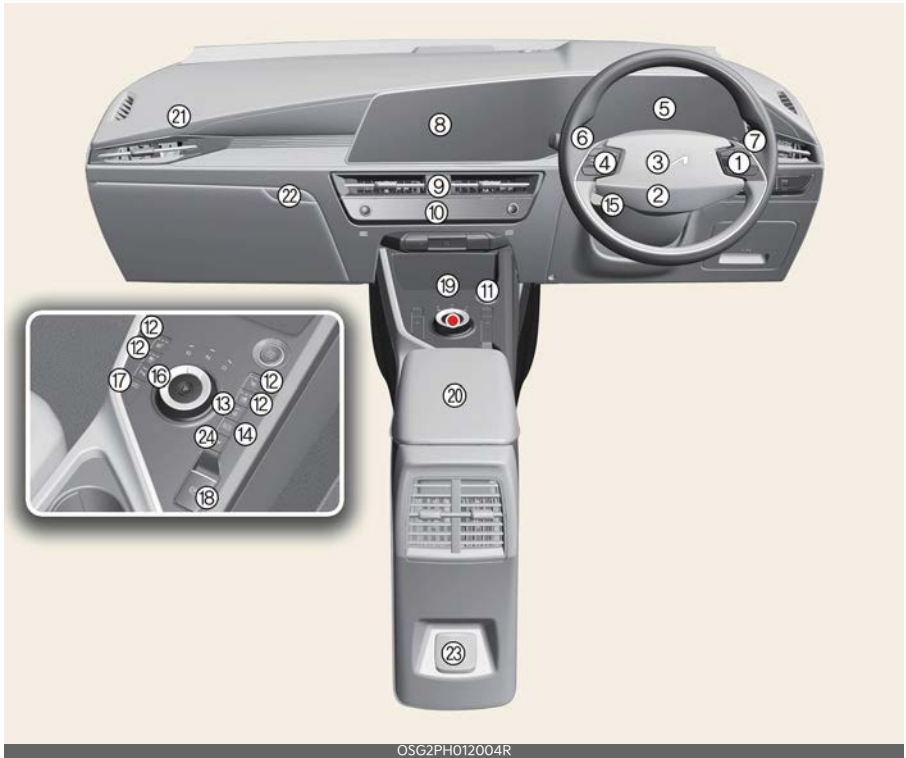

OSG2PH012004R

* The actual features in your vehicle may not necessarily be available due to the selected options or regions.

- | | |
|---|-------------|
| 1. Audio remote control button | 5-42 |
| 2. Driver's front air bag | 4-41 |
| 3. Horn | 5-45 |
| 4. Driving Assist button | 6-102 |
| 5. Instrument cluster | 5-49 |
| 6. Light control/turn signals lever | 5-73 |
| 7. Wiper and washer control lever | 5-78 |
| 8. Infotainment system | 5-108 |
| 9. Hazard warning flasher switch | 7-3 |
| 10. Climate control system | 5-86 |
| Infotainment/climate switchable controller | 5-87, 5-108 |
| 11. ENGINE START/STOP button | 6-10 |
| 12. Front seat warmer and air ventilation seat button | 5-100 |

13.Steering wheel heater button	5-44
14.AUTO HOLD button	6-35
15.Drive mode button	6-41
16.Parking Safety button	6-140, 6-143, 6-155
17.Parking/View button	6-128, 6-155
18.EPB button	6-32
19.Wireless smartphone charging system	5-104
20.Center console storage box	5-96
21.Passenger's front air bag	4-41
22.Glove box	5-96
23.115V/220V Inverter	5-102
24.EV Button	1-16

Engine compartment

Smartstream G1.6 GD_i HEV

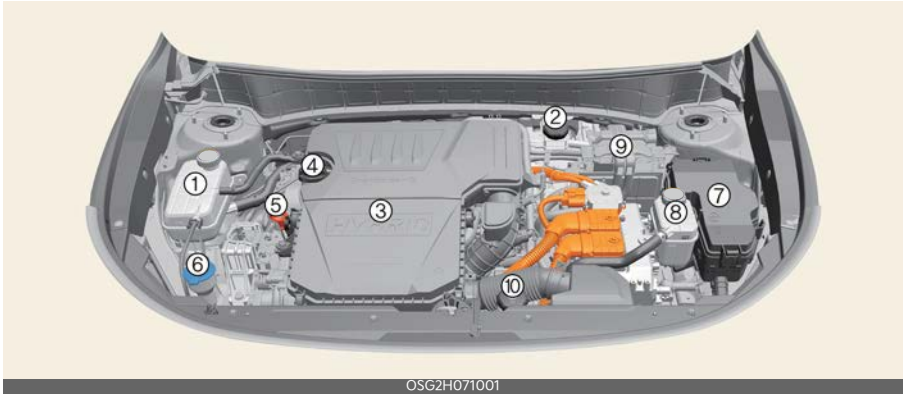

Smartstream G1.6 GD_i PHEV

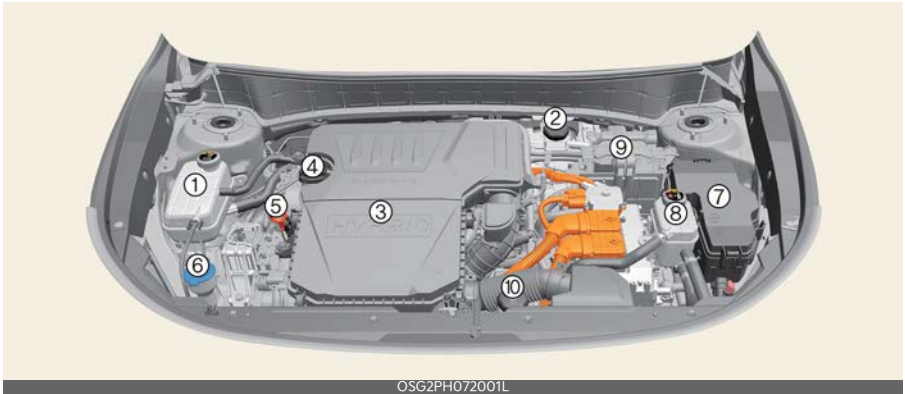

* The actual engine room in the vehicle may differ from the illustration.

1. Engine coolant reservoir	8-24
2. Brake fluid reservoir	8-28
3. Air cleaner	8-30
4. Engine oil filler cap	8-22
5. Engine oil dipstick	8-22
6. Windshield washer fluid reservoir	8-30
7. Fuse box	8-46
8. Inverter coolant reservoir	8-25, 8-26
9. Electric Control Unit (ECU)	7-5
10. Engine actuator reservoir tank	8-29

Seat	4-3
• Feature of seat leather	4-4
• Infotainment system.....	4-4
• Adjusting the front seat.....	4-5
• Relaxion comfort seat (for passenger's seat).....	4-5
• Seatback pocket.....	4-6
• Adjusting the rear seat	4-8
• Unfolding rear seatback	4-8
Headrest	4-10
• Adjusting the headrest	4-10
• Adjusting the headrest forward and backward (for front seats).....	4-10
• Removing/reinstalling the headrest	4-10
Armrest	4-12
• Adjusting the armrest.....	4-12
Seat belts	4-12
• Seat belt restraint system.....	4-13
• Seat belt precautions.....	4-19
• Care of seat belts	4-21
Child restraint system (CRS)	4-22
• Our recommendation: Children always in the rear	4-22
• Selecting a Child Restraint System (CRS)	4-22
• Installing a Child Restraint System (CRS).....	4-24
ISOFIX anchorage and top-tether anchorage (ISOFIX anchorage system) for children	4-24
• Securing a Child Restraint System with the "ISOFIX Anchorage System"	4-25
• Securing a Child Restraint System seat with "Top-tether Anchorage" system.....	4-25
• Securing a Child Restraint System with a lap/shoulder belt.....	4-26

4 Safety features of your vehicle

- Suitability of each seating position for belted & ISOFIX Child Restraint Systems according to UN regulations for Europe (Information for use by vehicle users and CRS manufacturers) 4-27
- Suitability of each seating position for belted & ISOFIX Child Restraint Systems (CRS) according to UN regulations for General (Information for use by vehicle users and CRS manufacturers)..... 4-29
- Suitability of each seating position for belted & ISOFIX Child Restraint Systems according to UN regulations for Latin America (Information for use by vehicle users and CRS manufacturers) 4-30
- Recommended CRS for Vehicle in Latin America according to UN regulations (Information for use by vehicle users and CRS manufacturers)..... 4-31
- Suitability of each seating position for belted & ISOFIX Child Restraint Systems (CRS) according to UN regulations for Australia (Information for use by vehicle users and CRS manufacturers) 4-32
- Air bag - supplemental restraint system 4-33**
 - Air bag warning and indicator light 4-36
 - Passenger's front air bag ON/OFF settings 4-36
 - SRS components and functions 4-39
 - Driver's and passenger's front air bag 4-41
 - Side air bag and front center air bag 4-43
 - Curtain air bag 4-44
 - Air bag collision sensors 4-46
 - Air bag inflation conditions 4-47
 - Air bag non-inflation conditions 4-48
 - SRS care 4-50
 - Additional safety precautions 4-51
 - Adding equipment to or modifying your air bag-equipped vehicle 4-52
 - Air bag warning labels 4-52

Safety features of your vehicle

Seat



OSG2PH032024L_6

* The actual features in your vehicle may not necessarily be available due to the selected options or regions.

* The picture above is based on LHD vehicle. For RHD vehicle, the operation of front seat are located on the opposite side.

Front seat

- 1 Forward and backward
- 2 Seatback angle
- 3 Seat height
- 4 Cushion tilt
- 5 Lumbar support
- 6 Relaxion comfort seat
- 7 Driver position memory system

8 Headrest

2nd-row seat

- 9 Seatback angle/folding
- 10 Armrest
- 11 Headrest

Feature of seat leather

- Our car seats are upholstered with a combination of artificial and genuine leather. The genuine leather is made from the outer skin of an animal, which goes through a special process to be available for use. Since it is a natural substance, each part differs in thickness or density. Also, wrinkles could appear depending on the temperature and humidity.
- The seat cover is made of stretchable material to improve comfort of passengers.
- The parts contacting the body are curved and the side supporting area is high which provides driving comfort and stability.
- Wrinkles may appear naturally from usage. It is not a fault of the product.

⚠ CAUTION

- Wrinkles or abrasions which appear naturally from usage are not covered by warranty.
- Belts with metallic accessories, zippers or keys inside the back pocket may damage the seat fabric.
- Make sure not to wet the seat. It may change the nature of leather.
- Jeans or clothes which could bleach may contaminate the surface of the seat covering fabric.

Infotainment system

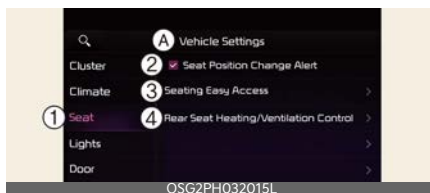

A: Vehicle settings

- 1 Seat
- 2 Seat Position Change Alert
- 3 Seating Easy Access
- 4 Rear Seat Heating/Ventilation Control

Select **Settings** → **Vehicle** → **Seat** from the Settings menu in the infotainment system screen, you may use various convenience functions.

- **Seat Position Change Alert** : When the seat position changes, details of the change are shown with a seat image.
- **Seating Easy Access**
 - **Seat Slide Easy Access** : the seat automatically moves when the driver enters or leaves the vehicle may be selected.
- **Rear Seat Heating/Ventilation Control**: The rear seat warmer/ventilation can be controlled from the front seat.

The information provided may differ according to which functions are applicable to your vehicle.

* INFORMATION

The infotainment system may change after software updates. For more information, refer to the manual provided in the infotainment system and the quick reference guide.

Adjusting the front seat

Operation

The seat can be adjusted by using the control levers located on the outside of the seat cushion.

* INFORMATION

Adjust the seat before driving, and make sure the seat is locked securely by trying to move without using the lever. If the seat moves, it is not locked properly.

Manual seat



- 1 Forward/backward
- 2 Seatback angle
- 3 Seat height

Power seat (if equipped)



- 1 Forward/backward
- 2 Seatback angle
- 3 Seat height
- 4 Cushion tilt

Lumbar support (if equipped)



- 1 Increase support
- 2 Decrease support

Relaxion comfort seat (for passenger's seat) (if equipped)

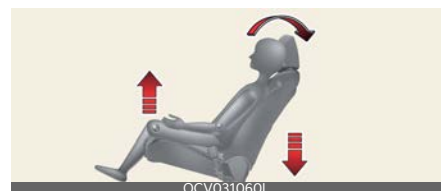

Relaxion comfort seats distribute body pressure and concentrated weight on specific body parts that occur while sitting in the same position for a long period of time. The seat relieves fatigue and discomfort by providing the optimal sit position.

⚠ CAUTION

Take the following precautions when using the relaxion comfort seat:

- Do not use the relaxion comfort seat while the vehicle is moving. Using the comfort seat could increase the risk of injuries in the event of a collision or sudden stop.
- Do not use the relaxion comfort seat while the vehicle is moving. The shoulder belt may not adhere to your chest firmly.
- Do not use the relaxion comfort seat when the luggage or other objects are placed at the rear seat.
- Do not use the relaxion comfort seat when the rear seats are not in the rearmost position and upright.

Operating relaxion comfort seat



Operation

1. Press the rear portion of the switch (A) more than 1 second.
2. An alarm appears on the infotainment screen.
3. Press the switch (A) again for more than 1 seconds within 5 seconds.

4. If the seat adjustment switch (reclining (B), cushion height (C)) is operated during relaxion comfort seat operating, the operation will stop.
5. After the operation is complete, it can be adjusted more using the seat adjustment switch (B, C) for a more comfortable posture.

Operating condition(s)

- Power button is ACC, ON, START/RUN position
- Passenger's side rear seat seatbelt is not fastened

Returning relaxion comfort seat

Operation

If you press the front portion of the switch (A) more than 1 second while the seat is in the relaxion comfort seat position, the seat return backs to the original position.

*** NOTICE**

When relaxion comfort seat cannot be operated, try to reset Integrated Memory System. If relaxion comfort seat does not operate even after Integrated Memory System is reset, it is recommended that you contact an authorized Kia dealer/ service partner.

Seatback pocket



- 1 Seatback pocket
- 2 USB charger

⚠ WARNING

- Loose objects in the driver's foot area could interfere with the operation of the foot pedals, possibly causing an accident.
- When you return the seatback to its upright position, hold the seatback and return it slowly and be sure there are no other occupants around the seat. If the seatback is returned without being held and controlled, the back of the seat could spring forward resulting in accidental injury to a person struck by the seatback.
- Riding in a vehicle with the seatback reclined could lead to serious or fatal injury in an accident.

If a seat is reclined during an accident, the occupant's hips may slide under the lap portion of the seatbelt, applying great force to the unprotected abdomen. Serious or fatal internal injuries could result. The driver must advise the passenger to keep the seatback in an upright position whenever the vehicle is in motion.

- Do not use a sitting cushion that reduces friction between the seat and passenger. The passenger's hips may slide under the lap portion of the seat belt during an accident or a sudden stop. Serious or fatal internal injuries could result because the seat belt can't operate normally.
- Never attempt to adjust any seat while the vehicle is moving. This could result in loss of control, and an accident causing death, serious injury, or property damage.
- Do not allow anything to interfere with the normal position of the seatback. Storing items against a seatback or in any other way interfering with proper

locking of a seatback could result in serious or fatal injury in a sudden stop or collision.

- Always drive and ride with your seatback upright and the lap portion of the seat belt snug and low across the hips. This is the best position to protect you in case of an accident.
- In order to avoid unnecessary and perhaps severe air bag injuries, always sit as far back as possible from the steering wheel while maintaining comfortable control of the vehicle. We recommend that your chest is at least 250 mm (10 inches) away from the steering wheel.
- The rear seatback must be securely latched. If not, passengers and objects could be thrown forward resulting in serious injury or death in the event of a sudden stop or collision.
- Luggage and other cargo should be laid flat in the cargo area. If objects are large, heavy, or must be piled, they must be secured. Under no circumstances should cargo be piled higher than the seatbacks. Failure to follow these warnings could result in serious injury or death in the event of a sudden stop, collision or rollover.
- No passenger should ride in the cargo area or sit or lie on folded seatbacks while the vehicle is moving. All passengers must be properly seated in seats and restrained properly while riding.
- When resetting the seatback to the upright position, make sure it is securely latched by pushing it forward and backwards.
- To avoid the possibility of burns, do not remove the carpet in the cargo area. Emission control devices

beneath this floor generate high temperatures.

- After adjusting the seat, always check that it is securely locked into place by attempting to move the seat forward or backward without using the lock release lever. Sudden or unexpected movement of the driver's seat could cause you to lose control of the vehicle resulting in an accident.
- Do not adjust the seat while wearing seat belts. Moving the seat cushion forward may cause strong pressure on the abdomen.
- Use extreme caution so that hands or other objects are not caught in the seat mechanisms while the seat is moving.
- Do not put a cigarette lighter on the floor or seat. When you operate the seat, gas may gush out of the lighter and cause fire.
- If there are occupants in the rear seats, be careful while adjusting the front seat position.
- Use extreme caution when picking small objects trapped under the seats or between the seat and the center console. Your hands might be cut or injured by the sharp edges of the seat mechanism.
- The power seat is operable with the ignition OFF. Therefore, children should never be left unattended in the car.

- When in operation, the power seat consumes a large amount of electrical power. To prevent unnecessary charging system drain, don't adjust the power seat longer than necessary while the engine is not running.
- Do not operate two or more power seat control switches at the same time. Doing so may result in power seat motor or electrical component malfunction.

Adjusting the rear seat

Folding rear seatback



Operation

1. Lower the rear headrests to the lowest position.
2. Pull on the seatback folding lever, then fold the seat toward the front of the vehicle.

Unfolding rear seatback



1. While pulling on the seatback folding lever, lift and pull the seatback backward. Pull the seatback firmly until it clicks into place.
2. Return the rear seat belt to the proper position

CAUTION

- The power seat is driven by an electric motor. Stop operating once the adjustment is completed. Excessive operation may damage the electrical equipment.

3. If you want to tilt the rear seatback a bit more, while pulling on the seatback folding lever and push the top of the rear seatback towards the rear.

WARNING

- Never attempt to adjust while the vehicle is moving or the rear seat is occupied as the seat may suddenly move and cause the passenger on the seat to be injured.
- The purpose of the fold-down rear seatbacks is to allow you to carry longer objects that could not be accommodated in the cargo area. Never allow passengers to sit on top of the folded down seatback while the vehicle is moving. This is not a proper seating position and no seat belts are available for use. This could result in serious injury or death in case of an accident or sudden stop. Objects carried on the folded down seatback should not extend higher than the top of the front seatbacks. This could allow cargo to slide forward and cause injury or damage during sudden stops.
- Do not fold the rear seats if passengers, pets or luggage are in the rear seats. It may cause injury or damage to passengers, pets or luggage.
- When you return the seatback to its upright position, hold the seatback and return it slowly. If the seatback is returned without holding it, the back of the seat could spring forward resulting in injury caused by being struck by the seatback.
- Cargo should always be secured to prevent it from being thrown about the vehicle in a collision and causing injury to the vehicle occupants. Do not place objects in the rear seats, since they cannot be properly secured and may hit the front seat occupants in a collision.
- Make sure the engine is off, the automatic is in P (Park), and the parking brake is securely applied whenever loading or unloading cargo. Failure to take these steps may allow the vehicle to move if the shift lever or dial is inadvertently moved to another position.
- Never attempt to adjust while the vehicle is moving or the rear seat is occupied as the seat may suddenly move and cause the passenger on the seat to be injured.
- Do not allow your hands or fingers to get caught in the seat mechanisms while adjusting the seats.
- When returning the rear seatbacks to the upright position, remember to return the rear shoulder belts to their proper position. Routing the seat belt webbing through the rear seat belt guides will help keep the belts from being trapped behind or under the seats.
- When you fold the rear seatback, insert the buckle in the pocket between the rear seatback and cushion. Doing so can prevent the buckle from being damaged by the rear seatback.

CAUTION

- Avoid excessive force when unfolding rear seat back.
- Unfolding the seat with excessive force may lead to lock seat back in 2nd step. This is natural phenomenon and adjust to the desired position if necessary.

Headrest

The seats are equipped with a headrest for the occupant's safety and comfort.



Adjusting the headrest

Front

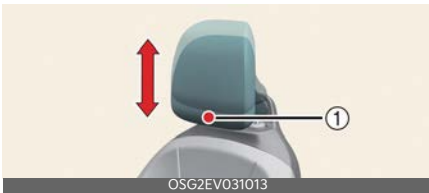

Rear

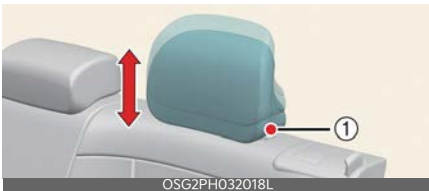

Operation

- Pull up the headrest to raise.
- Push and hold the release button (1) to lower the headrest.

Adjusting the headrest forward and backward (for front seats) (if equipped)



Operation

- Pull the headrest fully forward and release it.

* INFORMATION

The headrest may be adjusted forward to 3 different positions by pulling the headrest forward.

Removing/reinstalling the headrest

Front



Rear

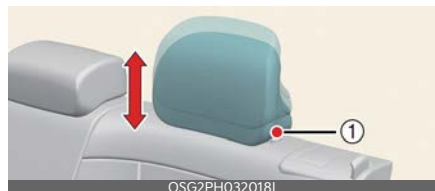

Operation

- Push and hold the release button (1) while pulling the headrest up.
- Do it in reverse order to reinstall the headrest.

⚠ WARNING

- For maximum effectiveness in case of an accident, the headrest should be adjusted so the middle of the headrest is at the same height of the center of gravity of an occupant's head. Generally, the center of gravity of most people's head is similar with the height of the top of their eyes. Also,

adjust the headrest as close to your head as possible. For this reason, the use of a cushion that holds the body away from the seatback is not recommended.



- Do not operate the vehicle with the headrests removed or reversed as severe injury to the occupants may occur in the event of an accident. Headrests may provide protection against neck injuries when properly adjusted.
- Do not adjust the headrest position of the driver's seat while the vehicle is in motion.
- Make sure the headrest locks in position after adjusting it to properly protect the occupants.
- NEVER allow anyone to ride in a seat with the headrests removed.
- Always make sure the headrest locks into position after reinstalling and adjusting it properly.

⚠ CAUTION

- When there is no occupant in the rear seats, adjust the height of the headrest to the lowest position. The rear seat headrest can reduce the visibility of the rear area.
- If you recline the seatback towards the front with the headrest and seat cushion raised, the headrest may come in contact with the sun visor or other parts of the vehicle.

Armrest

Adjusting the armrest



Operation

1. Pull the armrest forward from the seatback.

Seat belts

Seat belts are designed to bear upon the bony structure of the body, and should be worn low across the front of the pelvis, chest and shoulders.

⚠ WARNING

- For maximum restraint system protection, the seat belts must always be used whenever the car is moving.
- Seat belts are most effective when seatbacks are in the upright position.
- Children age 13 and younger must always be properly restrained in the rear seat. Never allow children to ride in the front passenger seat. If a child over 13 must be seated in the front seat, he/she must be properly belted and the seat should be moved as far back as possible.
- Never wear the shoulder belt under your arm or behind your back. An improperly positioned shoulder belt can cause serious injuries in a crash. The shoulder belt should be positioned midway over your shoulder across your collarbone.
 - Never wear a seat belt over fragile objects. If there is a sudden stop or impact, the seat belt can damage it.
 - Avoid wearing twisted seat belts. A twisted belt can't do its job as well. In a collision, it could even cut into you. Be sure the belt webbing is straight and not twisted.
 - Be careful not to damage the belt webbing or hardware. If the belt webbing or hardware is damaged, replace it.
- Seat belts are designed to bear upon the bony structure of the body, and should be worn low across the front of the pelvis or the pelvis, chest and

shoulders, as applicable; wearing the lap section of the belt across the abdominal area must be avoided. Seat belts should be adjusted as firmly as possible, consistent with comfort, to provide the protection for which they have been designed. A slack belt will greatly reduce the protection afforded to the wearer. Care should be taken to avoid contamination of the webbing with polishes, oils and chemicals, and particularly battery acid. Cleaning may safely be carried out using mild soap and water. The belt should be replaced if webbing becomes frayed, contaminated or damaged. It is essential to replace the entire assembly after it has been worn in a severe impact even if damage to the assembly is not obvious. Belts should not be worn with straps twisted. Each belt assembly must only be used by one occupant; it is dangerous to put a belt around a child being carried on the occupant's lap.

- No modifications or additions should be made by the user which will either prevent the seat belt adjusting devices from operating to remove slack, or prevent the seat belt assembly from being adjusted to remove slack.
- When you fasten the seat belt, be careful not to latch the seat belt in buckles of other seat. It's very dangerous and you may not be protected by the seat belt properly.
- Do not unfasten the seat belt and do not fasten and unfasten the seat belt repeatedly while driving. This could result in loss of control, and an accident causing death, serious injury, or property damage.
- When fastening the seat belt, make sure that the seat belt does not pass over objects that are hard or can break easily.
- Make sure there is nothing in the buckle. The seat belt may not be fastened securely.

Seat belt restraint system

Seat belt warning light

Front seat belt warning light

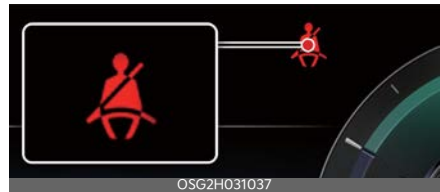

Operating condition(s)

- When the vehicle is running
 - The front seat belt warning light will appear for approximately 6 seconds.
- When the front seat belt is unfastened
 - For driver's seat, the front seat belt warning chime will sound for approximately 6 seconds.
 - The front seat belt warning light will stay appeared.
- When the front seat belt is unfastened during driving and the vehicle speed is under approximately 20 km/h (12 mph)
 - The front seat belt warning light will appear.
- When the vehicle speed is over approximately 20 km/h (12 mph)
 - The warning chime will sound for approximately 100 seconds.

- The front seat belt warning light will blink.

Rear passenger's seat belt warning lights



- Rear seat: (1) Driver's side, (2) Center, (3) Passenger's side

Operating condition(s)

For rear left and right seat

- When the vehicle is running
 - Rear passenger's seat belt warning light will appear for approximately 6 seconds.
- When the seat belt is unfastened during driving and the vehicle speed is under approximately 20 km/h (12 mph)
 - Rear passenger's seat belt warning light will stay appeared.
- When the vehicle speed is over approximately 20 km/h (12 mph)
 - Rear passenger's seat belt warning chime will sound for approximately 35 seconds.
 - Rear passenger's seat belt warning light will blink.
- When the vehicle is driven without the seat belt fastened, or the driver has unfastened the seat belt when the vehicle speed is over approximately 20 km/h (12 mph)
 - Rear passenger's seat belt warning chime will sound for approximately 35 seconds.

- Rear passenger's seat belt warning light will blink.

For rear center seat

- When the vehicle is running
 - Rear passenger's seat belt warning light will appear for approximately 6 seconds.
- When the seat belt is unfastened during driving and the vehicle speed is under approximately 20 km/h (12 mph)
 - Rear passenger's seat belt warning light will appear for approximately 70 seconds.
- When the vehicle speed is over approximately 20 km/h (12 mph)
 - Rear passenger's seat belt warning chime will sound for approximately 35 seconds
 - Rear passenger's seat belt warning light will blink.

Non-operating condition(s)

- When the rear door is opened or closed, and the vehicle speed is under 10 km/h (6 mph)
 - Seat belt warning light and the seat belt warning chime will not work even if the vehicle speed is over approximately 20 km/h (12 mph).

⚠ WARNING

Riding in an improper position adversely affects the front seat belt warning system. It is important for the driver to instruct the passenger to properly be seated as instructed in this manual.

*** NOTICE**

- Although the front passenger seat is not occupied, the seat belt warning light will blink or appear for 6 seconds.
- The front passenger's seat belt warning may operate when luggage is placed.

Fastening and releasing the seat belt

3-point system with emergency locking retractor



Operation

- To fasten the seat belt, insert the metal tab into the buckle (2).
- To release the seat belt, press the release button (1) in the locking buckle.

*** INFORMATION**

There will be an audible "click" when the tab locks into the buckle.

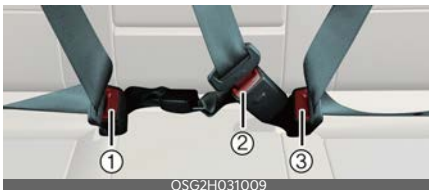

- 1 Rear right seat belt fastening buckle
- 2 Rear center seat belt fastening buckle (with the "CENTER" mark)
- 3 Rear left seat belt fastening buckle

⚠ WARNING

- You should place the lap belt portion as low as possible and snugly across your hips, not on your waist. If the lap belt is located too high on your waist, it may increase the chance of injury in the event of a collision. Both arms should not be under or over the belt. Rather, one should be over and the other under, as shown in the illustration. Never wear the seat belt under the arm near the door.
- Prior to fastening the rear seat belts, ensure the latch matches the seat belt buckle. Forcefully fastening the left or right seat belt to the center buckle can result in an improper fastening scenario that will not protect you in an accident.

⚠ CAUTION

Do NOT fold down the left portion of the rear seatback when the rear center seat belt is buckled. ALWAYS UNBUCKLE the rear center seat belt before folding down the left portion of the rear seatback. If the rear center seat belt is buckled when the left portion of the rear seatback is folded down, distortion and damage to the top portion of the seatback and seat belt garnish may result, causing the seatback to lock into the folded down position.

2-point system (rear center seat) (if equipped)

- To fasten the seat belt:
 - With a 2-point static type seat belt, the length must be adjusted manually so it fits snugly around your body. Fasten the belt and pull on the loose end to tighten it.

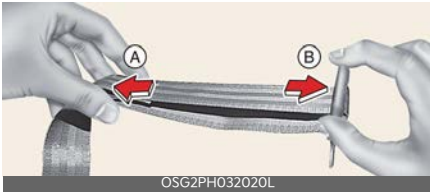

[A]: Shorten, [B]: Lengthen

- To fasten a 2-point static type belt, insert the metal tab (1) into the locking buckle (2).



- To release the seat belt, press the button (1) in the locking buckle.



*** NOTICE**

- The belt should be placed as low as possible on your hips, not on your waist. If the belt is too high, it could increase the possibility of you being injured in an accident.
- When using the rear center seat belt, the buckle with the "CENTER" mark must be used.

Adjusting height of the shoulder belt

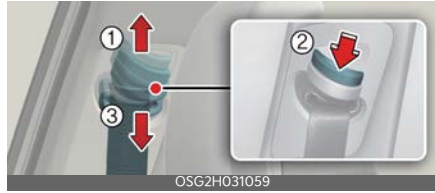

Operation

- Pull the height adjuster up (1).
- Press the height adjuster button (2) and push the height adjuster down (3).

⚠ WARNING

- After a collision, the seat belt system should be inspected to ensure it is operating normally. Replace any belts that are not functioning appropriately.
- Verify the shoulder belt anchor is locked into position at the appropriate height. Never position the shoulder belt across your neck or face.

⚠ CAUTION

- Do not force to lock the left or right seat belt into the center seat belt buckle. Make sure to lock the rear center seat belt into the center seat belt buckle. If not, the improperly fastened seat belt will not be able to provide protection.
- When pulling out to wear the seat belt, the tongue should be slowly pulled out of the seat belt guide so that the seat belt guide does not come off the trim.

*** NOTICE**

If you are not able to pull out the seat belt from the retractor, firmly pull the belt out and release it. Then you will be able to pull the belt out smoothly.

Pre-tensioner seat belt (if equipped)

Your vehicle is equipped with driver's, front passenger's and rear passengers' pre-tensioner seat belts.



Your vehicle is equipped with driver's and front passenger's Pre-tensioner seat belts.

The purpose of the pre-tensioner is to make sure that the seat belts fit tightly against the occupant's body in certain collisions.

The pre-tensioner seat belts may be activated in crashes where the collision is severe enough.

When the vehicle stops suddenly, or if the occupant tries to lean forward too quickly, the seat belt retractor will lock into position. In certain frontal collisions, the pre-tensioner will activate and pull the seat belt into tighter contact against the occupant's body.

1 Retractor Pre-tensioner

The purpose of the retractor pre-tensioner is to make sure that the shoulder belts fit in tightly against the occupant's upper body in certain frontal collisions.

If the system senses excessive tension on the driver or passenger's seat belt when the pre-tensioner system activates, the load limiter inside the retractor pre-tensioner will release some of the pressure on the affected seat belt. (if equipped)

The seat belt pre-tensioner system consists mainly of the following components. Their locations are shown in the illustration:



- 1** SRS air bag warning light
- 2** Front retractor pre-tensioner assembly
- 3** SRS control module

Operating condition(s)

- When the vehicle stops suddenly, or if the occupant tries to lean forward too quickly, the seat belt retractor will lock into position.
- In certain frontal collisions, the pre-tensioner will activate and pull the seat belt into tighter contact against the occupant's body.
- When the system senses excessive tension on the driver or passenger's seat belt when the pre-tensioner system activates, the load limiter inside the retractor pre-tensioner will release some of the pressure on the affected seat belt.

⚠ WARNING

- For your safety, be sure that the belt webbing is not loose or twisted and always sit properly on your seat.
- To obtain maximum benefit from a pre-tensioner seat belt:
 1. The seatbelt must be working correctly and adjusted to the proper position. Please read and follow all of the important information and precautions about your vehicle's occupant safety features - including seat belts and air bags that are provided in this manual.
 2. Be sure you and your passengers always wear their seat belts, and wear them properly.
- Pre-tensioner seat belt systems are designed to operate only one time. After activation, pre-tensioner seat belts must be replaced. All seat belts of any type should always be replaced after they have been worn during a collision.
- The pre-tensioner seat belt assembly mechanisms become hot during activation. Do not touch the pre-tensioner seat belt assemblies for several minutes after they have been activated.
- Do not attempt to inspect or replace the pre-tensioner seat belts yourself. Have the system inspected by a professional workshop. Kia recommends to visit an authorized Kia dealer/service partner.
- Do not attempt to service or repair the pre-tensioner seat belt system in any manner.
- Improper handling of the pre-tensioner seat belt assemblies, and failure to heed the warnings not to strike, modify, inspect, replace, service or

repair the pre-tensioner seat belt assemblies may lead to improper operation or inadvertent activation and serious injury.

- Always wear the seat belts when driving or riding in a motor vehicle.
- If the vehicle or pre-tensioner seat belt must be discarded, contact a professional workshop. Kia recommends to visit an authorized Kia dealer/service partner.
- Body work on the front area of the vehicle may damage the pre-tensioner seat belt system. Therefore, have the system serviced by a professional workshop. Kia recommends to visit an authorized Kia dealer/ service partner.

⚠ CAUTION

If the pre-tensioner seat belt is not working properly, the SRS air bag warning light will appear even if there is no malfunction of the SRS air bag. If the SRS air bag warning light does not appear when the ignition key is turned to ON, or if it remains appeared after appearing for approximately 3~6 seconds, or if it appears while the vehicle is being driven, have the system inspected by a professional workshop. Kia recommends to visit an authorized Kia dealer/service partner.

*** NOTICE**

- The pre-tensioner will activate not only in a frontal collision but also in a side collision, if the vehicle is equipped with a side or curtain air bag.
- When the pre-tensioner seat belts are activated, a loud noise may be heard

and fine dust, which may appear to be smoke, may be visible in the passenger compartment. These are normal operating conditions and are not hazardous.

- Although it is harmless, the fine dust may cause skin irritation and should not be breathed for prolonged periods. Wash all exposed skin areas thoroughly after an accident in which the pre-tensioner seat belts were activated.
- Because the sensor that activates the SRS air bag is connected with the pre-tensioner seat belt, the SRS air bag warning light on the instrument panel will appear for approximately 3~6 seconds after the vehicle is in ON position, and then it should turn off.

Seat belt precautions

⚠ WARNING

All occupants of the vehicle must wear their seat belts at all times. Seat belts and child restraints reduce the risk of serious or fatal injuries for all occupants in the event of a collision or sudden stop. Without a seat belt, occupants could be shifted too close to a deploying air bag, strike the interior structure or be thrown from the vehicle. Properly worn seat belts greatly reduce these hazards. Always follow the precautions about seat belts, air bags and occupant seat contained in this manual.

Infant or small child

You should be aware of the specific requirements in your country. Child and/or infant seats must be properly placed and installed in the rear seat.

*** INFORMATION**

Refer to "Child restraint system (CRS)" on page 4-22.

⚠ WARNING

Every person in your vehicle needs to be properly restrained at all times, including infants and children. Never hold a child in your arms or lap when riding in a vehicle. The violent forces created during a crash will tear the child from your arms and throw the child against the interior. Always use a child restraint appropriate for your child's height and weight.

*** NOTICE**

Small children are best protected from injury in an accident when properly restrained in the rear seat by a child restraint system that meets the requirements of the Safety Standards of your country. Before buying any child restraint system, make sure that it has label certifying that it meets Safety Standards of your country. The restraint must be appropriate for your child's height and weight. Check the label on the child restraint for this information. Refer to "Child restraint system (CRS)" on page 4-22.

Larger children

Children who are too large for child restraint systems should always occupy the rear seat and use the available lap/shoulder belts. The lap portion should be fastened and snugged on the hips and as low as possible. Check if the belt fits periodically. A child's squirming could put the belt out of position. Children are afforded the most safety in the event of

an accident when they are restrained by a proper restraint system in the rear seat. If a larger child (over age 13) must be seated in the front seat, the child should be securely restrained by the available lap/shoulder belt and the seat should be placed in the rearmost position. Children age 13 and under should be restrained securely in the rear seat. NEVER place a child age 13 and under in the front seat. NEVER place a rear facing child seat in the front seat of a vehicle. If the shoulder belt portion slightly touches the child's neck or face, try placing the child closer to the center of the vehicle. If the shoulder belt still touches their face or neck they need to be returned to a child restraint system.

WARNING

- Never allow a shoulder belt to be in contact with a child's neck or face while the vehicle is in motion.
- If seat belts are not properly worn and adjusted on children, there is a risk of death or serious injury.

Pregnant women

The use of a seat belt is recommended for pregnant women to lessen the chance of injury in an accident. When a seat belt is used, the lap belt portion should be placed as low and snugly as possible on the hips, not across the abdomen. For specific recommendations, consult a physician.

WARNING

Pregnant women must never place the lap portion of the safety belt over the area of the abdomen where the fetus is located or above the abdomen where

the belt could crush the fetus during an impact.

Injured person

A seat belt should be used when an injured person is being transported. When this is necessary, you should consult a physician for recommendations.

One person per belt

Two people (including children) should never attempt to use a single seat belt. This could increase the severity of injuries in case of an accident.

Do not lie down

To reduce the chance of injuries in the event of an accident and to achieve maximum effectiveness of the restraint system, all passengers should be sitting up and the front seats should be in an upright position when the car is moving. A seat belt cannot provide proper protection if the person is lying down in the rear seat or if the front seat is in a reclined position.

WARNING

Riding with a reclined seatback increases your chance of serious or fatal injuries in the event of a collision or sudden stop. The protection of your restraint system (seat belts and air bags) is greatly reduced by reclining your seat. Seat belts must be snug against your hips and chest to work properly. The more the seatback is reclined, the greater the chance that an occupant's hips will slide under the lap belt causing serious internal injuries or the occupant's neck could strike the shoulder belt. Drivers and passengers should always sit

well back in their seats, properly belted, and with the seatbacks upright.

Care of seat belts

Seat belt systems should never be disassembled or modified. In addition, care should be taken to assure that seat belts and belt hardware are not damaged by seat hinges, doors or other abuse.

WARNING

- When you return the rear seatback to its upright position after the rear seatback was folded down, be careful not to damage the seat belt webbing or buckle. Be sure that the webbing or buckle does not get caught or pinched in the rear seat. A seat belt with damaged webbing or buckle will not be as strong and could possibly fail during a collision or sudden stop, resulting in serious injury. If the webbing or buckles are damaged, get them replaced immediately.
 - Seat belts can become hot in a vehicle that has been closed up in sunny weather. They could burn infants and children.
-

Periodic inspection

It is recommended that all seat belts be inspected periodically for wear or damage of any kind. Any damaged parts should be replaced as soon as possible.

Keep belts clean and dry

Seat belts should be kept clean and dry. If belts become dirty, they can be cleaned by using a mild soap solution and warm water. Bleach, dye, strong detergents or abrasives should not be

used because they may damage and weaken the fabric.

When to replace seat belts

Entire in-use seat belt assembly or assemblies should be replaced if the vehicle has been involved in an accident. This should be done even if no damage is visible. In this case, have the system replaced by a professional workshop. Kia recommends to consult an authorized Kia dealer/service partner.

Child restraint system (CRS)

Our recommendation: Children always in the rear

Infants and younger children must be restrained in an appropriate rearward-facing or forward-facing CRS that has first been properly secured to the seat of the vehicle. Read and comply with the instructions for installation and use provided by the manufacturer of the Child Restraint System.

Children under age 13 should always ride in the rear seats and must always be properly restrained to minimize the risk of injury in an accident, sudden stop or sudden maneuver.

According to accident statistics, children are safer when properly restrained in the rear seats than in the front seat. Children too large for a Child Restraint System must use the seat belts provided.

Most countries have regulations which require children to travel in approved Child Restraint Systems.

The laws governing the age or height/weight restrictions at which seat belts can be used instead of Child Restraint System differs among countries, so you should be aware of the specific requirements in your country, and where you are traveling.

Child Restraint Systems must be properly installed in the vehicle seat. Always use a commercially available Child Restraint System that meets the requirements of your country.

WARNING

- Always properly restrain children in the vehicle. Children of all ages are safer when riding in the rear seats. Never place a rearward-facing Child Restraint System on the front passen-

ger seat, unless the air bag is deactivated.

- Always follow the Child Restraint System manufacturer's instructions for installation and use.
- Always properly restrain your child in the Child Restraint System.
- Do not use an infant carrier or a child safety seat that "hooks" over a seatback, it may not provide adequate protection in an accident.
- After an accident, have the system checked by a professional workshop. Kia recommends to visit an authorized Kia dealer/service partner.

Selecting a Child Restraint System (CRS)

Operation

1. Select a Child Restraint System based on your child's height and weight. The required label or the instructions for used typically provide this information.
2. Select a Child Restraint System that fits the vehicle seating position where it will be used.

* INFORMATION

- Make sure the Child Restraint System has a label certifying that it meets the applicable Safety Standards of your country.

A Child Restraint System may only be installed if it was approved in accordance with the requirements of ECE-R44 or ECE-R129 or relevant regulation.

- Select a Child Restraint System based on your child's height and weight. The

required label or the instructions for use typically provide this information.

- Select a Child Restraint System that fits the vehicle seating position where it will be used.

For the suitability of Child Restraint Systems on the vehicle's seating positions, please refer to "Suitability of each seating position for belted & ISO-FIX Child Restraint Systems according to UN regulations for Europe (Information for use by vehicle users and CRS manufacturers)" on page 4-27.

- Read and comply with the warnings and instructions for installation and use provided with the Child Restraint System.

Child restraint system types

Forward/rearward-facing Child Restraint System

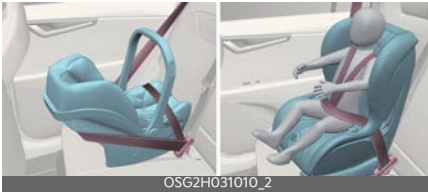

A rearward-facing Child Restraint System provides restraint with the seating surface against the back of the child. The harness system holds the child in place, and in an accident, acts to keep the child positioned in the Child Restraint Systems and reduce the stress to the fragile neck and spinal cord.

All children under the age of one year must always ride in a rearward-facing Child Restraint System. There are different types of rearward-facing Child Restraint Systems: infant-only Child Restraint Systems can only be used rear-

ward-facing. Convertible and 3-in-1 Child Restraint Systems typically have higher height and weight limits for the rearward-facing position, allowing you to keep your child rearward-facing for a longer period of time.

Keep using Child Restraint Systems in the rearward-facing position as long as children fit within the height and weight limits allowed by the Child Restraint System's manufacturer.

A forward-facing Child Restraint System provides restraint for the child's body with a harness. Keep children in a forward-facing Child Restraint System with a harness until they reach the top height or weight limit allowed by your Child Restraint System's manufacturer.

Once your child outgrows the forward-facing Child Restraint System, your child is ready for a booster seat.

Booster seats

A booster seat is a Child Restraint System designed to improve the fit of the vehicle's seat belt system. A booster seat positions the seat belt so that it fits properly over the stronger parts of your child's body. Keep your children in booster seats until they are big enough to fit in a seat belt properly.

For a seat belt to fit properly, the lap belt must lie comfortable across the upper thighs, not the stomach. The shoulder belt should lie comfortable across the shoulder and chest and not across the neck or face. Children under age 13 must always be properly restrained to minimize the risk of injury in an accident, sudden stop or sudden maneuver.

Installing a Child Restraint System (CRS)

Operation

1. Properly secure the Child Restraint System to the vehicle.
2. Make sure the Child Restraint System is firmly secured.
3. Secure the child in the Child Restraint System.

WARNING

- Before installing your Child Restraint System always: Read and follow the instructions provided by the manufacturer of the Child Restraint System. Failure to follow all warnings and instructions could increase the risk of the serious injury or death if an accident occurs.
- If the vehicle's headrest prevents proper installation of a Child Restraint System, the headrest of the respective seating position shall be readjusted or entirely removed.

CAUTION

A Child Restraint System in a closed vehicle can become very hot. To prevent burns, check the seating surface and buckles before placing your child in the Child Restraint System.

ISOFIX anchorage and top-tether anchorage (ISOFIX anchorage system) for children

ISOFIX anchorages are metal bars built into the vehicle. There are two lower anchors for each ISOFIX seating position that will accommodate a Child Restraint System with lower attachments.



- 1 ISOFIX anchor position indicator
- 2 ISOFIX anchor

ISOFIX anchorages have been provided in the left and right outboard rear seating positions.



WARNING

Do not attempt to install a Child Restraint System using ISOFIX anchorages in the rear center seating position. There are no ISOFIX anchorages provided for this seat. Using the outboard seat anchorages, for the CRS installation

on the rear center seating position, can damage the anchorages.

Securing a Child Restraint System with the "ISOFIX Anchorage System"

When not using the ISOFIX system, all Child Restraint Systems must be secured to a rear seat with the lap part of a lap/shoulder belt.

Operation

1. Move the seat belt buckle away from the ISOFIX anchorages.
2. Move any other objects away from the anchorages.
3. Place the Child Restraint System on the vehicle seat, then attach the seat to the ISOFIX anchorages according to the instructions provided by the Child Restraint System manufacturer.
4. Follow the instructions of the Child Restraint System's manufacturer for proper installation and connection of the ISOFIX attachments on the Child Restraint System to the ISOFIX anchorages.

⚠ WARNING

Take the following precautions when using the ISOFIX system:

- Read and follow all installation instructions provided with your Child Restraint System.
- To prevent the child from reaching and taking hold of unretracted seat belts, buckle all unused rear seat belts and retract the seat belt webbing behind the child. Children can be strangled if a shoulder belt becomes wrapped around their neck and the seat belt tightens.

- NEVER attach more than one Child Restraint System to a single anchorage. This could cause the anchor or attachment to come loose or break.
- Always have the ISOFIX (i- Size) system inspected by your dealer after an accident. An accident can damage the ISOFIX system and may not properly secure the Child Restraint System.

Securing a Child Restraint System seat with "Top-tether Anchorage" system

Type A



Type B

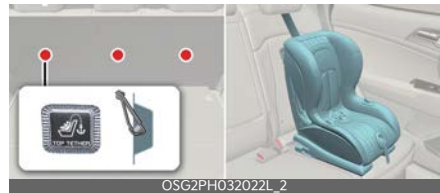

Operation

1. Route the Child Restraint System seat strap over the seatback.
2. Connect the top-tether to the top-tether anchorage,
3. Tighten the top-tether according to the instructions of your Child Restraint System's manufacturer.

⚠ WARNING

Take the following precautions when installing the top-tether:

- Read and follow all installation instructions provided with your Child Restraint System.
- NEVER attach more than one Child Restraint System to a single ISOFIX top-tether anchorage. This could cause the anchorage or attachment to come loose or break.
- Do not attach the top-tether to anything other than the correct top-tether anchorage. It may not work properly if attached to something else.
- Child restraint anchorages are designed to withstand only those loads imposed by correctly fitted Child restraints. Under no circumstances are they to be used for adult seat belts or harnesses or for attaching other items or equipment to the vehicle.

3. Remove as much slack from the belt as possible by pushing down on the Child Restraint System while feeding the shoulder belt back into the retractor.
4. Push and pull on the Child Restraint System to confirm that the seat belt is holding it firmly in place.
5. If your Child Restraint System manufacturer recommends the use of a top-tether with the lap/shoulder belt, see Securing a Child Restraint System seat with "Top-tether Anchorage" system section in this chapter.
6. To remove the Child Restraint System, press the release button on the buckle and then pull the lap/shoulder belt out of the Child Restraint System and allow the seatbelt to retract fully.

Securing a Child Restraint System with a lap/shoulder belt

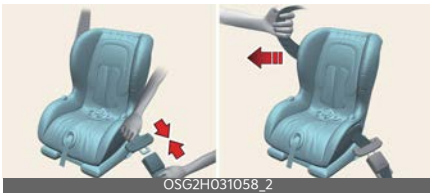

Operation

1. Place the Child Restraint System on a rear seat and route the lap/shoulder belt around or through the Child Restraint System.
2. Fasten the lap/shoulder belt latch into the buckle.

Suitability of each seating position for belted & ISOFIX Child Restraint Systems according to UN regulations for Europe (Information for use by vehicle users and CRS manufacturers)

- Yes : Suitable for fitment of the designated category of CRS
- No : Not suitable for fitment of the designated category of CRS
- "-": Not applicable
- The table is based on LHD vehicle. Except for the front passenger seat, the table is valid for RHD vehicle.
For RHD vehicle front passenger seat, please use information for the seating position number 3.

F: Forward facing

R: Rearward facing

CRS categories		Seating positions					
		1, 2	3		4	5	6
			Airbag ON	Airbag Off			
Universal belted CRS	All mass groups	-	No	Yes ^{*1} (F, R)	Yes (F, R)	Yes ^{*2} (F, R)	Yes (F, R)
i-size CRS	ISOFIX CRF: F2, F2X, R1, R2	-	No	No	Yes (F, R)	No	Yes (F, R)
Carry-cot (ISOFIX lateral facing CRS)	ISOFIX CRF: L1, L2	-	No	No	No	No	No
ISOFIX infant* CRS (*: ISOFIX baby CRS)	ISOFIX CRF: R1	-	No	No	Yes (R)	No	Yes (R)
ISOFIX toddler CRS - small	ISOFIX CRF: F2, F2X, R2, R2X	-	No	No	Yes (F, R)	No	Yes (F, R)
ISOFIX toddler CRS - large* (*: not booster seats)	ISOFIX CRF: F3, R3	-	No	No	Yes (F, R)	No	Yes (F, R)
Booster Seat - reduced width	ISO CRF: B2	-	No	No	Yes	No	Yes
Booster Seat - full width	ISO CRF: B3	-	No	No	Yes	No	Yes

* 1. To install Universal CRS, 1st row passenger seat should be adjusted appropriate position which do not interfere stable installation (adjust to possible height or upright position)

* 2. Never install CRS with a support leg on 2nd row center seating position

Seat Number	Position in the vehicle	Seating positions
1	Front left	
2	Front center	
3	Front right	
4	2nd row left	
5	2nd row center	
6	2nd row right	

* If the head restraints prevent proper installation of a CRS, the head restraints of the seating position shall be readjusted or entirely removed.

* Never place a rearward facing Child Restraint System on the front passenger seat, unless the air bag is deactivated.

Recommended CRS for Vehicle in Europe according to UN regulations (Information for use by vehicle users and CRS manufacturers)

Child Height or Mass Group	CRS Manufacturer	CRS Model name	Type of Fixation	ECE Approval Number
40-83 cm	Britax Römer	BABY-SAFE 3 i-SIZE with Flex Base i-Sense	ISOFIX with support leg (Rearward facing)	E1*129R03/04*0060
76-105 cm	Britax Römer	TRIFIX2 i-SIZE	ISOFIX and top-tether	E1*129R02/06*0015
Group II	Britax Römer	KidFix II R	ISOFIX and vehicle belt, using CRS lap belt guide	R44/04 - E1 - 04301304
Group III	Graco	Junior III Booster Basic	Vehicle belt	R44: E11-0444165

CRS Manufacturer information (for Europe)

Britax: <http://www.britax.com>

Graco: <http://www.gracobaby.com>

Suitability of each seating position for belted & ISOFIX Child Restraint Systems (CRS) according to UN regulations for General (Information for use by vehicle users and CRS manufacturers)

- Yes : Suitable for fitment of the designated category of CRS
- No : Not suitable for fitment of the designated category of CRS
- "-": Not applicable
- The table is based on LHD vehicle. Except for the front passenger seat, the table is valid for RHD vehicle.
For RHD vehicle front passenger seat, please use information for the seating position number 3.

F: Forward facing

R: Rearward facing

CRS categories		Seating positions					
		1, 2	3	4	5		6
					2 Point-belt	3 Point-belt	
Universal belted CRS	All mass groups	-	No	Yes (F, R)	Yes (F)	Yes ² (F, R)	Yes (F, R)
i-size CRS	ISOFIX CRF: F2, F2X, R1, R2	-	No	Yes (F, R)	No	No	Yes (F, R)
Carry-cot (ISOFIX lateral facing CRS)	ISOFIX CRF: L1, L2	-	No	No	No	No	No
ISOFIX infant* CRS (*: ISOFIX baby CRS)	ISOFIX CRF: R1	-	No	Yes (R)	No	No	Yes (R)
ISOFIX toddler CRS - small	ISOFIX CRF: F2, F2X, R2, R2X	-	No	Yes (F, R)	No	No	Yes (F, R)
ISOFIX toddler CRS - large* (*: not booster seats)	ISOFIX CRF: F3, R3	-	No	Yes (F, R)	No	No	Yes (F, R)
Booster Seat - reduced width	ISO CRF: B2	-	No	Yes	No	No	Yes
Booster Seat - full width	ISO CRF: B3	-	No	Yes	No	No	Yes

* 1. To install Universal CRS, 1st row passenger seat should be adjusted appropriate position which do not interfere stable installation (adjust to possible height or upright position).

* 2. Never install CRS with a support leg on 2nd row center seating position.

Seat Number	Position in the vehicle	Seating positions
1	Front left	
2	Front center	
3	Front right	
4	2nd row left	
5	2nd row center	
6	2nd row right	

* If the head restraints prevent proper installation of a CRS, the head restraints of the seating position shall be readjusted or entirely removed.

* Never place a rearward facing Child Restraint System on the front passenger seat, unless the air bag is deactivated.

Suitability of each seating position for belted & ISOFIX Child Restraint Systems according to UN regulations for Latin America (Information for use by vehicle users and CRS manufacturers)

- Yes: Suitable for fitment of the designated category of CRS
- No: Not suitable for fitment of the designated category of CRS
- "-": Not applicable
- The table is based on LHD vehicle. Except for the front passenger seat, the table is valid for RHD vehicle.
For RHD vehicle front passenger seat, please use information for the seating position number 3.

F: Forward facing

R: Rearward facing

CRS categories		Seating positions				
		1, 2	3	4	5	6
Universal belted CRS	All mass groups	-	No	Yes (F, R)	Yes ² (F, R)	Yes (F, R)
i-size CRS	ISOFIX CRF: F2, F2X, R1, R2	-	No	Yes (F, R)	No	Yes (F, R)
Carry-cot (ISOFIX lateral facing CRS)	ISOFIX CRF: L1, L2	-	No	No	No	No
ISOFIX infant* CRS (*: ISOFIX baby CRS)	ISOFIX CRF: R1	-	No	Yes (R)	No	Yes (R)
ISOFIX toddler CRS - small	ISOFIX CRF: F2, F2X, R2, R2X	-	No	Yes (F, R)	No	Yes (F, R)
ISOFIX toddler CRS - large* (*: not booster seats)	ISOFIX CRF: F3, R3	-	No	Yes (F, R)	No	Yes (F, R)
Booster Seat - reduced width	ISO CRF: B2	-	No	Yes	No	Yes
Booster Seat - full width	ISO CRF: B3	-	No	Yes	No	Yes

* 1. To install Universal CRS, 1st row passenger seat should be adjusted appropriate position which do not interfere stable installation (adjust to possible height or upright position).

* 2. Never install CRS with a support leg on 2nd row center seating position.

Seat Number	Position in the vehicle	Seating positions
1	Front left	
2	Front center	
3	Front right	
4	2nd row left	
5	2nd row center	
6	2nd row right	

* If the head restraints prevent proper installation of a CRS, the head restraints of the seating position shall be readjusted or entirely removed.

* Never place a rearward facing Child Restraint System on the front passenger seat, unless the air bag is deactivated.

Recommended CRS for Vehicle in Latin America according to UN regulations (Information for use by vehicle users and CRS manufacturers)

Mass group	CRS Manufacturer	CRS Model name	Type of Fixation	ECE Approval Number
Group 0+//II/III	JOIE	JOIE SPIN 360	ISOFIX & Leg Support Type (Rear & Forward-Facing)	E11-041621

CRS Manufacturer information (for Latin America)

JOIE: <http://www.joiebaby.com>

Suitability of each seating position for belted & ISOFIX Child Restraint Systems (CRS) according to UN regulations for Australia (Information for use by vehicle users and CRS manufacturers)

- Yes : Suitable for fitment of the designated category of CRS
- No : Not suitable for fitment of the designated category of CRS
- "-": Not applicable
- The table is based on LHD vehicle. Except for the front passenger seat, the table is valid for RHD vehicle.
For RHD vehicle front passenger seat, please use information for the seating position number 3.

F: Forward facing
R: Rearward facing

CRS categories		Seating positions				
		1, 2	3	4	5	6
Universal belted CRS	All mass groups	-	No	Yes (F, R)	Yes ^{*2} (F, R)	Yes (F, R)
i-size CRS	ISOFIX CRF: F2, F2X, R1, R2	-	No	Yes (F, R)	No	Yes (F, R)
Carry cot (ISOFIX lateral facing CRS)	ISOFIX CRF: L1, L2	-	No	No	No	No
ISOFIX infant* CRS (*: ISOFIX baby CRS)	ISOFIX CRF: R1	-	No	Yes (R)	No	Yes (R)
ISOFIX toddler CRS - small	ISOFIX CRF: F2, F2X, R2, R2X	-	No	Yes (F, R)	No	Yes (F, R)
ISOFIX toddler CRS - large* (*: not booster seats)	ISOFIX CRF: F3, R3	-	No	Yes (F, R)	No	Yes (F, R)
Booster Seat - Reduced width	ISO CRF: B2	-	No	Yes	No	Yes
Booster Seat - Full width	ISO CRF: B3	-	No	Yes	No	Yes

- * 1. To install Universal CRS, 1st row passenger seat should be adjusted appropriate position which do not interfere stable installation (adjust to possible height or upright position)
- * 2. Never install CRS with a support leg on 2nd row center seating position

Seat Number	Position in the vehicle	Seating positions
1	Front left	
2	Front center	
3	Front right	
4	2nd row left	
5	2nd row center	
6	2nd row right	

- * If the head restraints prevent proper installation of a CRS, the head restraints of the seating position shall be readjusted or entirely removed.
- * Never place a rearward facing Child Restraint System on the front passenger seat, unless the air bag is deactivated.

Air bag - supplemental restraint system

Left-hand drive

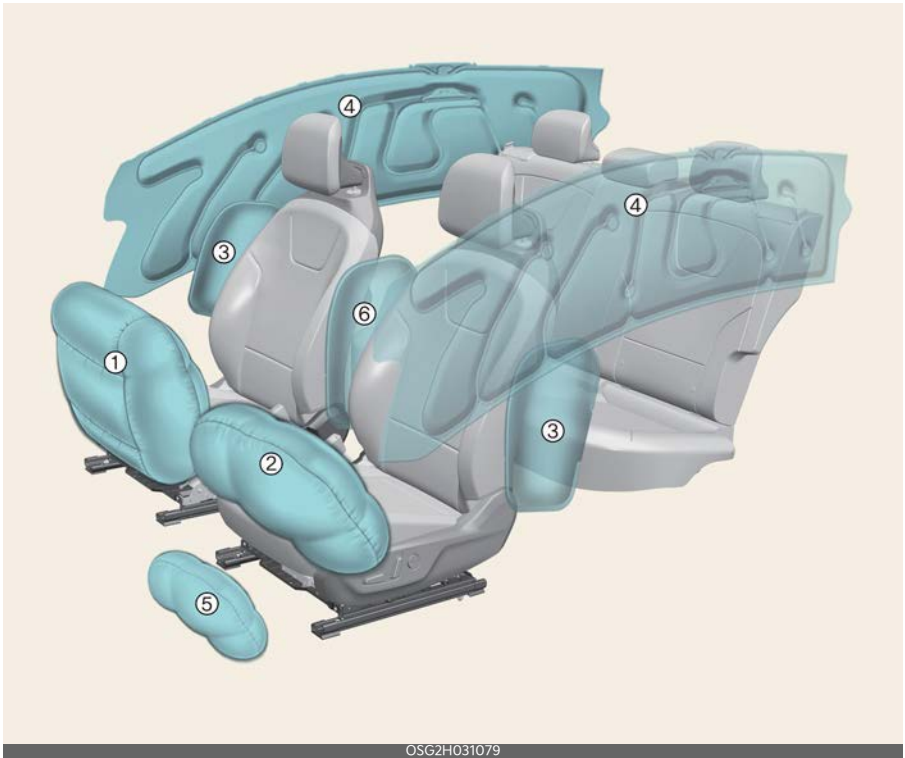

Right-hand drive

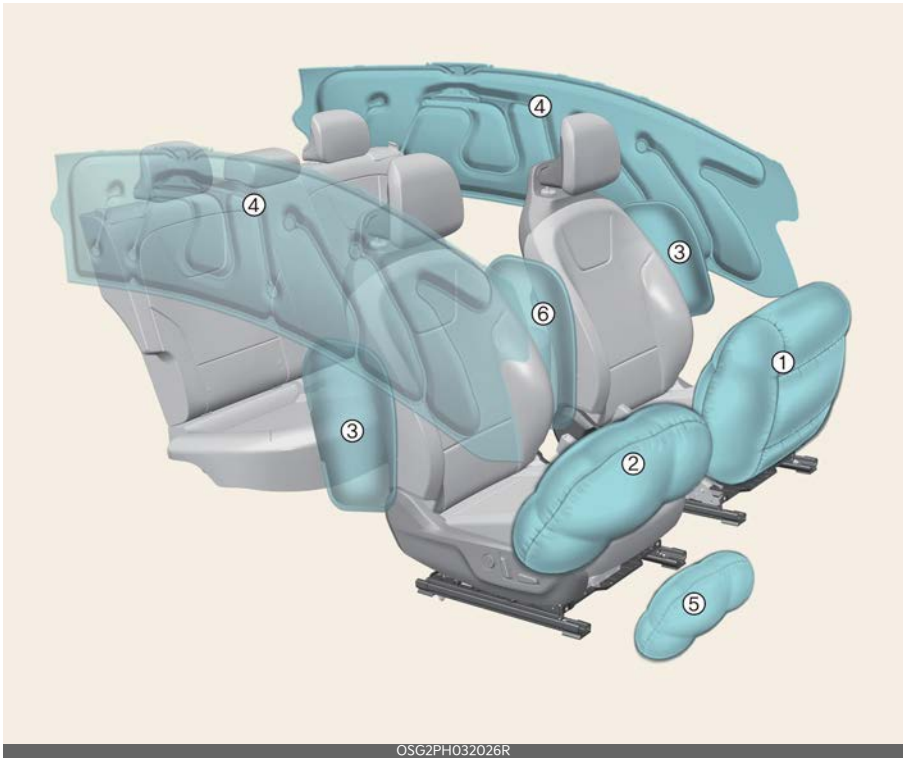

OSG2PH032026R

* The actual features in your vehicle may not necessarily be available due to the selected options or regions.

- 1 Passenger's front air bag
- 2 Driver's front air bag
- 3 Side air bag*
- 4 Curtain air bag*
- 5 Driver's knee air bag*
- 6 Front center side air bag*

* : if equipped

How does the air bag system operate?

- Air bags are activated (able to inflate if necessary) only when the vehicle is in the ON position and it can be activated within about 3 minutes after ignition off.
- Air bags inflate instantly in the event of serious frontal or side collision (if equipped with side air bag or curtain air bag) in order to help protect the occupants from serious physical injury.
- There is no single speed at which the air bags will inflate. Generally, air bags are designed to inflate based upon the severity of a collision and its direction. These two factors determine whether the sensors produce an electronic deployment/ inflation signal.
- Air bags will inflate based upon the severity of a collision and its direction, etc. Air bags will not inflate in every crash or collision situation.
- The front air bags will completely inflate and deflate in an instant. It is virtually impossible for you to see the air bags inflate during an accident. It is much more likely that you will simply see the deflated air bags hanging out of their storage compartments after the collision.
- In order to help provide protection in a severe collision, the air bags must inflate rapidly. The speed of air bag inflation is a consequence of extremely short time in which a collision occurs and the need to get the air bag between the occupant and the vehicle structures before the occupant impacts those structures. This speed of inflation reduces the risk of serious or life-threatening injuries in a severe collision and is thus a necessary part of air bag design.
- However, air bag inflation can also cause injuries which can include facial abrasions, bruises and broken bones because the inflation speed also causes the air bags to expand with a great deal of force.
- **There are even circumstances under which contact with the steering wheel air bag can cause fatal injuries, especially if the occupant is positioned excessively close to the steering wheel.**

WARNING

- Even in vehicles with air bags, you and your passengers must always wear the safety belts provided in order to minimize the risk and severity of injury in the event of a collision or in most rollover situations.
- SRS and pre-tensioners contain explosive chemicals. If scraping a vehicle without removing SRS and pre-tensioners from a vehicle, it may cause fire. Before scraping a vehicle, contact a professional workshop. Kia recommends to visit an authorized Kia dealer/service partner.
- Keep the SRS parts and wirings away from water or any liquid. If the SRS components are inoperative due to exposure to water or liquids, it may cause fire or severe injury.
- To avoid severe personal injury or death caused by deploying air bags in a collision, the driver should sit as far back from the steering wheel air bag. The front passenger should always move their seat as far back as possible and sit back in their seat.
- Air bag inflates instantly in an event of a collision, passengers may be injured

by the air bag expansion force if they are not in a proper position.

- Air bag inflation may cause injuries including facial or bodily abrasions, injuries from broken glasses or burns.

* NOTICE

If equipped with rollover sensor

Also, the air bags inflate instantly in the event of a rollover (if equipped with a side air bag or curtain air bag) in order to help protect the occupants from serious physical injury.

Noise and smoke

When the air bags inflate, they make a loud noise and they leave smoke and powder in the air inside of the vehicle. This is normal and is a result of the ignition of the air bag inflator. After the air bag inflates, you may feel substantial discomfort in breathing due to the contact of your chest with both the seat belt and the air bag, as well as from breathing the smoke and powder.

Open your doors and/or windows as soon as possible after impact in order to reduce discomfort and prevent prolonged exposure to the smoke and powder.

Though smoke and powder are non-toxic, it may cause irritation to the skin (eyes, nose and throat, etc.). If this is the case, wash and rinse with cold water immediately and consult the doctor if the symptom persists.

▲ WARNING

- When the air bags deploy, the air bag related parts in the steering wheel and/or instrument panel and/or in both sides of the roof rails above the

front and rear doors are very hot. To prevent injury, do not touch the air bag storage areas internal components immediately after an air bag has inflated.

- Do not install or place any accessories near air bag deployment areas, such as the instrument panel, windows, pillars, and roof rails.

Air bag warning and indicator light

Air bag warning light

Operating condition(s)

- When the engine is running, the warning light should appear for approximately 3~6 seconds, and go off.

Malfunction

- The light does not turn on briefly when the engine is running.
- The light stays on after appearing for approximately 3~6 seconds.
- The light comes on while the vehicle is in motion.
- The light blinks when the engine is running.

Passenger's front air bag ON/OFF settings (if equipped)

You can deactivate the passenger's front air bag from the User Settings Mode on the LCD display if a child restraint is installed on the front passenger's seat or if the front passenger's seat is unoccupied by a person. If your vehicle is equipped with infotainment system, please refer to the infotainment system manual separately supplied.



Operation

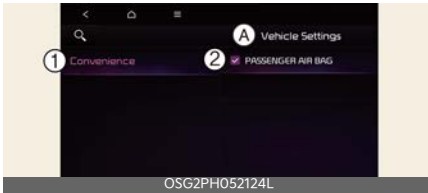
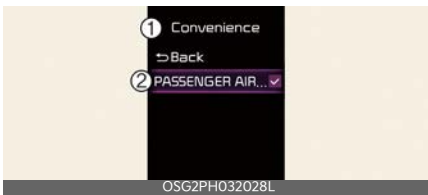

A: Vehicle Settings

1 Convenience

2 PASSENGER AIR BAG

With the vehicle on, touch **Settings** → **Convenience** → **PASSENGER AIR BAG** on the instrument cluster or **Settings** → **Vehicle** → **Convenience** → **PASSENGER AIR BAG** on the infotainment system screen.

* INFORMATION

- To ensure the safety of your child, the passenger's front air bag must be deactivated when it should be neces-

sary to install a rearward facing child seat on the front passenger seat in exceptional circumstances.

- The infotainment system may change after software updates. For more information, refer to the manual provided in the infotainment system and the quick reference guide.

Front passenger air bag ON/OFF indicator



4

Operating condition(s)

- After the vehicle is running
 - The Front passenger air bag ON or OFF indicator appears for approximately 4 seconds.
- When the PASSENGER AIR BAG menu is selected or deselected
 - The Front passenger air bag ON or OFF indicator is appeared.

WARNING

- The passenger's front air bag can be turned on or off by using Settings menu. Always check the status of the PASSENGER AIR BAG menu and Front passenger air bag ON/OFF indicator.
- The driver is responsible for the proper position of the PASSENGER AIR BAG menu.
- Never install a rearward facing child seat on the front passenger's seat unless the passenger's front air bag has been deactivated. The infant or child could be severely injured or

killed by an air bag deployment in case of an accident.

- Even though your vehicle is equipped with the PASSENGER AIR BAG menu, do not install a child restraint system in the front passenger's seat. A child restraint system must never be placed in the front seat. Children who are too large for child restraint systems should always occupy the rear seat and use the available lap/shoulder belts. In the event of an accident, children are afforded the most safety when they are restrained by a proper restraint system in the rear seat.
- As soon as the child seat is no longer needed on the front passenger's seat, reactivate the front passenger's air bag.
- Never place or insert any object into any small opening near side airbag labels attached to the vehicle seats. When the air bag deploys, the object may affect the deployment and result in unexpected accident or bodily harm.
- No objects (such as crash pad cover, cellular phone holder, cup holder, perfume or stickers) should be placed over or near the air bag modules on the steering wheel, instrument cluster, windshield glass, and the front passenger's panel above the glove box. Such objects could cause harm if the vehicle is in a crash severe enough to cause the air bags to deploy. Do not place any objects over the air bag or between the air bag and yourself.

⚠ CAUTION

- If the PASSENGER AIR BAG menu is not working properly, the air bag warning light on the instrument panel

will appear. And, the passenger's front air bag OFF indicator (🚫) will not appear (The passenger's front air bag ON indicator comes on), the SRS Control Module reactivate the passenger's front air bag and the passenger's front air bag will inflate in frontal impact crashes even if the PASSENGER AIR BAG menu is deselected (🚫). In this case, have the system inspected by a professional workshop. Kia recommends visiting an authorized Kia dealer/service partner.

- If the SRS air bag warning light blinks or does not appear when the ENGINE START/STOP button is in ON position, or if it appears while the vehicle is being driven, have the system inspected by a professional workshop. Kia recommends visiting an authorized Kia dealer/service partner.

*** NOTICE**

- The passenger's front air bag ON/OFF indicator generally appears for approximately 4 seconds after the vehicle is in the ON position. However, if the vehicle is in the ON position within 3 minutes after the vehicle was turned off, the indicator will not appear.
- When the PASSENGER AIR BAG menu is selected, the passenger's front air bag is activated and child or infant seat should not be installed on the front passenger's seat.
- When the PASSENGER AIR BAG menu is deselected, the passenger's front air bag is deactivated.

SRS components and functions

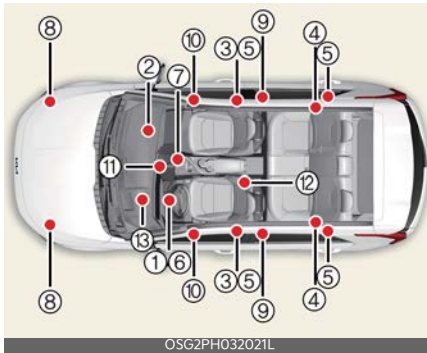

* The actual features in your vehicle may not necessarily be available due to the selected options or regions.

- 1 Driver's front air bag module
- 2 Passenger's front air bag module
- 3 Side air bag modules*
- 4 Curtain air bag modules*
- 5 Retractor pre-tensioner assemblies*
- 6 Air bag warning light/Passenger's front air bag ON/OFF menu
- 7 SRS control module (SRSCM)/rollover sensor*
- 8 Front impact sensors
- 9 Side impact sensors*
- 10 Side pressure sensors*
- 11 Passenger's front air bag ON/OFF menu*
- 12 Driver's center side air bag module*
- 13 Driver's knee air bag module*

* : if equipped

Operation

After the engine is running, the SRS air bag warning light on the instrument panel will appear for approximately 6 seconds.

The SRS air bag warning light on the instrument panel will appear for about 6 seconds after the vehicle is in the ON position, after which the air bag warning light should go out.

⚠ WARNING

If any of the following conditions occurs, this indicates a malfunction of the SRS. In this case, have the system inspected by a professional workshop. Kia recommends to visit an authorized Kia dealer/service partner.

- The light does not turn on briefly when you turn the vehicle ON.
- The light stays on after appearing for approximately 6 seconds.
- The light comes on while the vehicle is in motion.
- The light blinks when the vehicle is in ON position.

Driver's front air bag (1)



Driver's front air bag (2)



Driver's front air bag (3)



Passenger's front air bag



The air bag modules are located both in the center of the steering wheel and in the front passenger's panel above the glove box. When the SRSCM detects a sufficiently severe impact to the front of the vehicle, it will automatically deploy the front air bags.

Upon deployment, tear seams molded directly into the pad covers will separate under pressure from the expansion of the air bags. Further opening of the covers then allows full inflation of the air bags.

A fully inflated air bag, in combination with a properly worn seat belt, slows the driver's or the passenger's forward motion, reducing the risk of head and chest injury.

After complete inflation, the air bag immediately starts deflating, enabling the driver to maintain forward visibility and the ability to steer or operate other controls.

⚠ WARNING

- Do not install or place any accessories (drink holder, CD holder, sticker, etc.) on the front passenger's panel above

the glove box in a vehicle with a passenger's air bag. Such objects may become dangerous projectiles and cause injury if the passenger's air bag inflates.

- When installing a container of liquid air freshener inside the vehicle, do not place it near the instrument cluster nor on the instrument panel surface. It may become dangerous projectiles and cause injury if the passenger's air bag inflates.
- If an air bag deploys, there may be a loud noise followed by a fine dust released in the vehicle. These conditions are normal and are not hazardous - the air bags are packed in this fine powder. The dust generated during air bag deployment may cause skin or eye irritation as well as aggravate asthma for some persons. Always wash all exposed skin areas thoroughly with cold water and a mild soap after an accident in which the air bags were deployed.
- The SRS can function only when the vehicle is in the ON position. If the SRS air bag warning light does not appear, or continuously remains on after appearing for about 6 seconds when the vehicle is in the ON position, or after the engine is started, comes on while driving, the SRS is not working properly. In this case, have the system inspected by a professional workshop. Kia recommends to visit an authorized Kia dealer/service partner.
- Before you replace a fuse or disconnect a battery terminal, turn the ignition switch to the LOCK position and remove the ignition key or turn off the ENGINE START/STOP button. Never remove or replace the air bag related fuse(s) when the vehicle is in the ON

position. Failure to heed this warning will cause the SRS air bag warning light to appear.

Driver's and passenger's front air bag

Driver's front air bag / Passenger's front air bag



Driver's knee air bag (if equipped)



The indications of the system's presence are the letters "AIR BAG" intagliated on the air bag pad cover in the steering wheel and the passenger's side front panel pad above the glove box.

⚠ WARNING

- The driver's hands should be placed on the steering wheel at the 9:00 and 3:00 positions. The passenger's arms and hands should be placed on their laps.
- Always use seat belts and child restraints - every trip, every time, everyone! Air bags inflate with considerable force and in the blink of an eye. Seat belts help keep occupants in proper position to obtain maximum benefit from the air bag. Even with air bags, improperly and unbelted occu-

pants can be severely injured when the air bag inflates. Always follow the precautions about seat belts, air bags and occupant safety contained in this manual.

- To reduce the chance of serious or fatal injuries and receive the maximum safety benefit from your restraint system:
 - Never place a child in any child or booster seat in the front seat.
 - ABC - Always Buckle Children in the back seat. It is the safest place for children of any age to ride.
 - Front and side air bags can injure occupants improperly positioned in the front seats.
 - Move your seat as far back as practical from the front air bags, while still maintaining control of the vehicle.
 - You and your passengers should never sit or lean unnecessarily close to the air bags. Improperly positioned drivers and passengers can be severely injured by inflating air bags.
 - Never lean against the door or center console - always sit in an upright position.
 - No objects should be placed over or near the air bag modules on the steering wheel, instrument panel, and the front passenger's panel above the glove box, because any such object could cause harm if the vehicle is in a crash severe enough to cause the air bags to deploy.
 - Do not tamper with or disconnect SRS wiring or other components of the SRS system. Doing so could result in injury, due to accidental

deployment of the air bags or by rendering the SRS inoperative.

- If the SRS air bag warning light remains appeared while the vehicle is being driven, have the system inspected by a professional workshop. Kia recommends to visit an authorized Kia dealer/service partner.
- Air bags can only be used once - have the system replaced by a professional workshop.
Kia recommends to visit an authorized Kia dealer/service partner.
- The SRS is designed to deploy the front air bags only when an impact is sufficiently severe and when the impact angle is less than 30° from the forward longitudinal axis of the vehicle. Additionally, the air bags will only deploy once. Seat belts must be worn at all times.
- Front air bags are not intended to deploy in side-impact, rear-impact or rollover crashes. In addition, front air bags will not deploy in frontal crashes below the deployment threshold.
- A child restraint system must never be placed in the front seat. The infant or child could be severely injured or killed by an air bag deployment in case of an accident.
- Children age 13 and under must always be properly restrained in the rear seat. Never allow children to ride in the front passenger seat. If a child over age 13 must be seated in the front seat, he or she must be properly belted and the seat should be moved as far back as possible.
- For maximum safety protection in all types of crashes, all occupants

including the driver should always wear their seat belts whether or not an air bag is also provided at their seating position to minimize the risk of severe injury or death in the event of a crash. Do not sit or lean unnecessarily close to the air bag while the vehicle is in motion.

- Sitting improperly or out of position can result in serious or fatal injury in a crash. All occupants should sit upright with the seat back in an upright position, center on the seat cushion with their seat belt on, legs comfortably extended and their feet on the floor until the vehicle is parked and the ignition key is removed.
 - The SRS air bag system must deploy very rapidly to provide protection in a crash. If an occupant is out of position because of not wearing a seat belt, the air bag may forcefully contact the occupant causing serious or fatal injuries.
 - No objects (such as crash pad cover, cellular phone holder, cup holder, perfume or stickers) should be placed over or near the air bag modules on the steering wheel, instrument panel, windshield glass, and the front passenger's panel above the glove box. Such objects could cause harm if the vehicle is in a crash severe enough to cause the air bags to deploy. Do not place any objects over the air bag or between the air bag and yourself.
-

Side air bag and front center air bag (if equipped)

Your vehicle is equipped with a side air bag in each front seats and front center air bag in each front seat.



* The actual air bags in the vehicle may differ from the illustration.

The purpose of the air bag is to provide the vehicle's driver and/or the front passenger with additional protection than that offered by the seat belt alone.

The side air bags and front center air bag are designed to deploy only during certain side-impact collisions, depending on the crash severity. The side air bags and driver's center air bag are not designed to deploy in all side impact situations.



* The actual air bags in the vehicle may differ from the illustration.

⚠ WARNING

- Do not allow the passengers to lean their heads or bodies onto doors, put their arms on the doors, stretch their arms out of the window, or place objects between the doors and passengers when they are seated on seats equipped with side and/or curtain air bags.
- The side air bags and front center air bag are supplemental to the driver's and the passenger's seat belt systems and is not a substitute for them. Therefore your seat belts must be worn at all times while the vehicle is in motion. The air bags deploy only in certain side impact or rollover conditions (Only vehicle equipped with rollover sensor) severe enough to cause significant injury to the vehicle occupants.
- For best protection from the side air bag system and to avoid being injured by the deploying side air bag, both front seat occupants should sit in an upright position with the seat belt properly fastened.
- Do not use any accessory seat covers.
- Use of seat covers could reduce or prevent the effectiveness of the system.
- To prevent unexpected deployment of the side air bag that may result in personal injury, avoid impact to the side impact sensor when the vehicle is in ON position and within approximately 3 minutes after the vehicle is in OFF position.
- If the seat or seat cover is damaged, have the system serviced by a professional workshop.
Kia recommends to visit an authorized Kia dealer/service partner.

- Do not place any objects over the air bag or between the air bag and yourself. Also, do not attach any objects around the area the air bag inflates such as the door, side door glass, front and rear pillar.
- Do not place any objects between the door and the seat. They may become dangerous projectiles if the side air bag inflates.
- Do not install any accessories on the side or near the side air bags.

*** NOTICE**

If equipped with rollover sensor

Also, the air bags inflate instantly in the event of a rollover (if equipped with a side air bag or curtain air bag) in order to help protect the occupants from serious physical injury.

Curtain air bag (if equipped)



* The actual air bags in the vehicle may differ from the illustration.

Curtain air bags are located along both sides of the roof rails above the front and rear doors.

They are designed to help protect the heads of the front seat occupants and

the rear seat occupants in certain side impact collisions.

The curtain air bags are designed to deploy during certain side impact collisions, depending on the crash severity. The curtain air bags are not designed to deploy in all side impact situations, collisions from the front or rear of the vehicle or in most rollover situations.

⚠ WARNING

- Failure to follow the instructions mentioned can result in injury or death to the vehicle occupants in an accident.

- Do not hang heavy items on the coat hooks for safety reasons.
- In order for side and curtain air bags to provide the best protection, both front seat occupants and both outboard rear occupants should sit in an upright position with the seat belts properly fastened.

Importantly, children should sit in a proper child restraint system in the rear seat.

- When children are seated in the rear outboard seats, they must be seated in the proper child restraint system.

Make sure to put the child restraint system as far away from the door side as possible, and secure the child restraint system in a locked position.

- Do not allow the passengers to lean their heads or bodies onto doors, put their arms on the doors, stretch their arms out of the window, or place objects between the doors and passengers when they are seated on seats equipped with side and/or curtain air bags.

- Never try to open or repair any components of the curtain air bag system. If necessary, have the system serviced by a professional workshop. Kia recommends to visit an authorized Kia dealer/service partner.
- Do not place any objects over the air bag. Also, do not attach any objects around the area the air bag inflates such as the door, side door glass, front and rear pillar, roof side rail.
- Do not hang hard or breakable objects on the clothes hanger.

*** NOTICE****If equipped with rollover sensor**

Also, the air bags inflate instantly in the event of a rollover (if equipped with a side air bag or curtain air bag) in order to help protect the occupants from serious physical injury.

Air bag collision sensors



OSG2PH032001L



* The actual features in your vehicle may not necessarily be available due to the selected options or regions.

- 1 Supplemental Restraint System (SRS) control module/rollover sensor*
- 2 Front impact sensor
- 3 Side pressure sensors (front door)*
- 4 Side impact sensor (B-pillar)*

*: if equipped

⚠ WARNING

- Do not hit or allow any objects to impact the locations where air bag or sensors are installed.

This may cause unexpected air bag deployment, which could result in serious personal injury or death.

- If the installation location or angle of the sensors is altered in any way, the air bags may deploy when they should not or they may not deploy when they should, causing severe injury or death.

Therefore, do not try to perform maintenance on or around the air bag sensors. Have the system serviced by a professional workshop. Kia recommends to visit an authorized Kia dealer/service partner.

- Problems may arise if the sensor installation angles are changed due to the deformation of the front bumper, body or B pillar where side collision sensors are installed. In this case, have the system serviced by a professional workshop. Kia recommends to visit an authorized Kia dealer/ service partner.

- Your vehicle has been designed to absorb impact and deploy the air bag(s) in certain collisions. Use only Kia Genuine Parts or those of an equivalent standard to install bumper guards or replace a bumper. If not, it may adversely affect your vehicle's collision and air bag deployment performance.



- If equipped with rollover sensor**

If your vehicle is equipped with side and curtain air bag, set the ignition switch or ENGINE START/STOP button to OFF or ACC position and wait

for 3 minutes when the vehicle is being towed.

The side and curtain air bag may deploy when the vehicle is in ON position or the vehicle is in OFF position within 3 minutes, and the rollover sensor detects the situation as a rollover.

Air bag inflation conditions

Air bag inflation conditions	
 <p>OSG2PH032008L</p>	<p>Front air bags are designed to inflate in a frontal collision depending on the intensity, speed or angles of impact of the front collision.</p>
 <p>OSG2H031017</p>	<p>Side and/or curtain air bags are designed to inflate when an impact is detected by side collision sensors depending on the strength, speed or angles of impact resulting from a side impact collision.</p>
 <p>OSG2PH032009L</p>	

*** INFORMATION**

Side and curtain air bags (if equipped)

Also, the side and curtain air bags are designed to inflate when a rollover is detected by a rollover sensor.

Although the front air bags (driver's and front passenger's air bags) are designed to inflate only in frontal collisions, they also may inflate in other types of collisions if the front impact sensors detect a sufficient impact. Side air bags (side and/or curtain air bags) are designed to inflate only in side impact collisions, but they may inflate in other collisions if the side impact sensors detect a sufficient impact.

For instance, side airbag and curtain air bags may inflate if rollover sensors indicate the possibility of a rollover occurring (even if none actually occurs) or in

other situations, including when the vehicle is tilted while being towed. Even if side and/or curtain air bags do not provide impact protection in a rollover, they will deploy to prevent ejection of occupants, especially those who are restrained with seat belts.



If the vehicle chassis is impacted by bumps or objects on unimproved roads or sidewalks, air bags may deploy. Drive carefully on unimproved roads or on surfaces not designed for vehicle traffic to prevent unintended air bag deployment.





*** NOTICE**

If equipped with rollover sensor

Also, the side and curtain air bags are designed to inflate when a rollover is detected by a rollover sensor.

Air bag non-inflation conditions

Air bag non-inflation conditions	
 <p>OSG2PH032008L</p>	<p>In certain low-speed collisions the air bags may not deploy.</p>
 <p>OSG2PH032010L</p>	<p>Air bags are not designed to inflate in rear collisions.</p>
 <p>OSG2PH032011L</p>	<p>Heavy braking lowers the front portion of the vehicle causing it to "ride" under a vehicle with a higher ground clearance. Air bags may not inflate in this "under-ride" situation because deceleration forces that are detected by sensors may be significantly reduced by such "under-ride" collisions.</p>

Air bag non-inflation conditions	
 <p>OSG2H031029</p>	<p>In an angled collision, the force of impact may send the occupants in a direction where the air bags would not be able to provide any additional benefit; thus, the sensors may not deploy any air bags.</p>
 <p>OSG2PH032009L</p>	<p>Front air bags may not inflate in side impact collisions. However, if equipped with side and curtain air bags, the air bags may inflate depending on the intensity, vehicle speed and angles of impact.</p>
 <p>OSG2H031030</p>	<p>Air bags may not inflate in rollover accidents because the vehicle cannot detect the rollover. However, side and/or curtain air bags may inflate when the vehicle is rolled over following (or after) side impact collision.</p>
 <p>OSG2PH032012L</p>	<p>Air bags may not inflate if the vehicle collides with objects such as utility poles or trees, meaning the point of impact is concentrated in one area and the full force of the impact is not delivered to the sensors.</p>

⚠ WARNING

- The SRS is designed to deploy the front air bags only when an impact is sufficiently severe and when the impact angle is less than 30° from the forward longitudinal axis of the vehicle.
- Front air bags are not intended to deploy in side-impact, rear-impact or rollover crashes. In addition, front air bags will not deploy in frontal crashes below the deployment threshold.
- The air bags deploy only in certain side impact or rollover conditions (Only vehicle equipped with rollover sensor) severe enough to cause significant injury to the vehicle occupants.
- If your vehicle is equipped with side and curtain air bag, set the ignition switch or ENGINE START/STOP but-

ton to OFF or ACC position and wait for 3 minutes when the vehicle is being towed. This side and curtain air bag may deploy when the ignition is ON or the ignition is OFF within 3 minutes, and the rollover sensor detects the situation as a rollover.

- Do not hit or allow any objects to impact the locations where air bag or sensors are installed. This may cause unexpected air bag deployment, which could result in serious personal injury or death.
- If the installation location or angle of the sensors is altered in any way, the air bags may deploy when they should not or they may not deploy when they should, causing severe injury or death. Therefore, do not try to perform maintenance on or around the air bag sensors. Have the system serviced by a professional workshop. Kia recommends to visit an authorized Kia dealer/service partner.
- Your vehicle has been designed to absorb impact and deploy the air bag(s) in certain collisions. Use only Kia Genuine Parts or those of an equivalent standard to install bumper guards or replace a bumper. If not, it may adversely affect your vehicle's collision and air bag deployment performance.
- If an air bag deploys, there may be a loud noise followed by a fine dust released in the vehicle. These conditions are not hazardous.
- The air bags are packed in this fine powder. The dust generated during air bag deployment may cause skin or eye irritation as well as aggravate asthma for some persons. Always wash all exposed skin areas thor-

oughly with cold water and a mild soap after an accident in which the air bags were deployed.

- For cleaning the air bag pad covers, use only a soft, dry cloth or one which has been moistened with plain water.
- Solvents or cleaners could adversely affect the air bag covers and proper deployment of the system.
- Keep the SRS parts and wirings away from water or any liquid. If the SRS components are inoperative due to exposure to water or liquids, it may cause fire or severe injury.
- If any of the following conditions occurs, this indicates a malfunction of the SRS. In this case, have the system inspected by a professional workshop. Kia recommends to visit an authorized Kia dealer/service partner.
 - The light does not turn on briefly when you turn the ignition ON.
 - The light stays on after appearing for approximately 6 seconds.
 - The light comes on while the vehicle is in motion.
 - The light blinks when the ignition switch or ENGINE START/STOP button is in ON position.
- Before you replace a fuse or disconnect a battery terminal, turn the ignition switch or ENGINE START/STOP button to the LOCK position and remove the ignition key or turn off the ENGINE START/STOP button. Never remove or replace the air bag related fuse(s) when the ignition switch or ENGINE START/STOP button is in the ON position. Failure to heed this warning will cause the SRS air bag warning light to appear.
- Do not tamper with or disconnect wiring or other components of the SRS

system, including the addition of any kind of badges to the pad covers or modifications to the body structure. Doing so could adversely affect SRS performance and lead to possible injury. If necessary, have the system serviced by a professional workshop. Kia recommends to visit an authorized Kia dealer/service partner.

- If your car was flooded and has soaked carpeting or water on flooring, you shouldn't try to start the engine; in this case, have your vehicle inspected by a professional workshop. Kia recommends to contact an authorized Kia dealer/service partner.
- Air bags can only be used once. If the air bags inflate, have the system replaced by a professional workshop. Kia recommends to visit an authorized Kia dealer/service partner.
- If components of the air bag system must be discarded, or if the vehicle must be scrapped, certain safety precautions must be observed, such as removing SRS and pre-tensioners from a vehicle due to the risk of fire. Failure to follow these precautions and procedures could increase the risk of personal injury. An authorized Kia dealer knows these precautions and can give you the necessary information.

* NOTICE

- **If equipped with rollover sensor**
The side and curtain air bags are designed to inflate when a rollover is detected by a rollover sensor. The air bags may inflate in a rollover, when it is detected by the rollover sensor.

- **If equipped without rollover sensor**

However, side and/or curtain air bags may inflate when the vehicle is rolled over by a side impact collision, if the vehicle is equipped with side air bags and curtain air bags.

SRS care

The SRS is virtually maintenance-free and so there are no parts you can safely service by yourself.

If the SRS air bag warning light does not appear, or continuously remains on, have the system inspected by a professional workshop. Kia recommends to visit an authorized Kia dealer/service partner.

⚠ WARNING

- Modification to SRS components or wiring, including the addition of any kind of badges to the pad covers or modifications to the body structure, can adversely affect SRS performance and lead to possible injury.
- For cleaning the air bag pad covers, use only a soft, dry cloth or one which has been moistened with plain water. Solvents or cleaners could adversely affect the air bag covers and proper deployment of the system.
- No objects should be placed over or near the air bag modules on the steering wheel, instrument panel, and the front passenger's panel above the glove box, because any such object could cause harm if the vehicle is in a crash severe enough to cause the air bags to inflate.
- If the air bags inflate, have the system replaced by a professional workshop. Kia recommends to visit an authorized Kia dealer/service partner.

- Do not tamper with or disconnect SRS wiring, or other components of the SRS system. Doing so could result in injury, due to accidental inflation of the air bags or by rendering the SRS inoperative.
 - If components of the air bag system must be discarded, or if the vehicle must be scrapped, certain safety precautions must be observed. An authorized Kia dealer knows these precautions and can give you the necessary information. Failure to follow these precautions and procedures could increase the risk of personal injury.
 - If your car was flooded and has soaked carpeting or water on flooring, you shouldn't try to start the engine; in this case, have your vehicle inspected by a professional workshop. Kia recommends to contact an authorized Kia dealer/service partner.
- they could be seriously injured or killed in a collision.
- **Do not use any accessories on seat belts.** Devices claiming to improve occupant comfort or reposition the seat belt can reduce the protection provided by the seat belt and increase the chance of serious injury in a crash.
 - **Passengers should not place hard or sharp objects between themselves and the air bags.** Carrying hard or sharp objects on your lap or in your mouth can result in injuries if an air bag inflates.
 - **Keep occupants away from the air bag covers.** All occupants should sit upright, fully back in their seats with their seat belts on and their feet on the floor. If occupants are too close to the air bag covers, they could be injured if the air bags inflate.
 - **Do not attach or place objects on or near the air bag covers.** Any object attached to or placed on the front or side air bag covers could interfere with the proper operation of the air bags.
 - **Do not modify the front seats.** Modification of the front seats could interfere with the operation of the supplemental restraint system sensing components or side air bags.
 - **Do not place items under the front seats.** Placing items under the front seats could interfere with the operation of the supplemental restraint system sensing components and wiring harnesses.
 - **Never hold an infant or child on your lap.** The infant or child could be seriously injured or killed in the event of a crash. All infants and children should be properly restrained in

Additional safety precautions

- **Never let passengers ride in the cargo area or on top of a folded-down back seat.** All occupants should sit upright, fully back in their seats with their seat belts on and their feet on the floor.
- **Passengers should not move out of or change seats while the vehicle is moving.** A passenger who is not wearing a seat belt during a crash or emergency stop can be thrown against the inside of the vehicle, against other occupants, or out of the vehicle.
- **Each seat belt is designed to restrain one occupant.** If more than one person uses the same seat belt,

appropriate child safety seats or seat belts in the rear seat.

WARNING

- Sitting improperly or out of position can cause occupants to be shifted too close to a deploying air bag, strike the interior structure or be thrown from the vehicle resulting in serious injury or death.
- Always sit upright with the seatback in an upright position, centered on the seat cushion with your seat belt on, legs comfortably extended and your feet on the floor.

Adding equipment to or modifying your air bag-equipped vehicle

If you modify your vehicle by changing your vehicle's frame, bumper system, front end or side sheet metal or ride height, this may affect the operation of your vehicle's air bag system.

Air bag warning labels

Left-hand drive



OSG2H031032_2

Right-hand drive



OSG2PH032027R_2

Air bag warning label (Type A)



OVCV031062L

Air bag warning label (Type B)



OVCV031063L

Air bag warning labels are attached to alert the passengers of potential risk of air bag system.

Note that these government warnings focus on the risk of children. We also want you to be aware of the risks adult are exposed to which have been described in previous pages.

WARNING

- Never place a rear facing child restraint in the front passenger seat, unless the passenger-side air bag is deactivated. An inflating passenger-side air bag could impact the rear-facing child restraint and kill the child.
- Extreme Hazard! Do not use a rearward facing child restraint on a seat protected by an air bag in front of it!
- Never put a child restraint in the front passenger's seat. If the front passenger air bag inflates, it can cause serious or fatal injuries.
- NEVER use a rearward facing child restraint on a seat protected by an ACTIVE AIR BAG in front of it. DEATH or SERIOUS INJURY to the CHILD can occur.

- When children are seated in the rear outboard seats of a vehicle equipped with side and/or curtain air bags, be sure to install the child restraint system as far away from the door side as possible, and securely lock the child restraint system in position.

Inflation of side and/or curtain air bags could cause serious injury or death to an infant or child.

* NOTICE

If equipped with rollover sensor

- The air bags inflate instantly in the event of a rollover (if equipped with a side air bag or curtain air bag) in order to help protect the occupants from serious physical injury.
 - The side and/or the curtain air bag may deploy when the rollover sensor detects the situation as a rollover.
-

Features of your vehicle **5**

Keys	5-5
• Using the remote key	5-5
• Using the smart key	5-6
• Replacing the key battery	5-8
Theft-alarm system	5-9
• Armed stage	5-9
• Theft-alarm stage	5-9
• Disarmed stage	5-9
Immobilizer system	5-11
• Vehicles with the remote key	5-11
• Vehicles with the smart key	5-11
Door locks	5-12
• Door locks outside the vehicle	5-12
• Door locks inside the vehicle	5-14
• Door lock features	5-15
• Manual door lock switch	5-16
• Rear door locks	5-16
• Rear Occupant Alert (ROA)	5-17
Driver position memory system	5-18
• Setting memory position.....	5-18
• Recalling memory position	5-18
• Resetting the driver position memory system	5-19
• Easy access function	5-19
Tailgate	5-20
• Opening/closing the manual tailgate.....	5-20
• Power tailgate.....	5-20
Windows	5-28
• Controlling power windows switch	5-30
• Resetting power windows	5-30
• Power windows automatic reversal	5-30

5 Features of your vehicle

• Power windows lock button	5-31
• Remote window closing/opening (for front seats).....	5-31
Hood	5-33
• Opening the hood.....	5-33
• Closing the hood	5-34
Fuel filler door	5-35
• Opening the fuel filler door (Hybrid vehicle).....	5-35
• Opening the fuel filler door (Plug-in hybrid vehicle).....	5-35
• Closing the fuel filler door	5-37
Sunroof.....	5-39
• Sunshade.....	5-39
• Tilt open/close	5-39
• Slide open/close	5-40
• Automatic reversal	5-40
• Resetting the sunroof.....	5-41
• Sunroof open warning.....	5-42
Steering wheel	5-42
• Motor Driven Power Steering (MDPS)	5-42
• Adjusting steering wheel angle and height.....	5-42
• Heated steering wheel.....	5-44
• Horn.....	5-45
Mirrors	5-45
• Inside rear view mirror.....	5-45
• Outside rear view mirror.....	5-46
Instrument cluster.....	5-49
• Full LCD cluster	5-51
LCD display.....	5-54
• LCD display modes	5-54
• LCD display messages.....	5-62
Vehicle settings (infotainment system)	5-65

Features of your vehicle **5**

Warning and indicator lights	5-67
Head-Up Display (HUD)	5-71
• Head Up Display Information	5-72
• Head-Up Display Setting	5-72
Lighting	5-73
• Lighting functions	5-73
• Lighting controls.....	5-73
• High Beam Assist (HBA).....	5-75
• Headlamp leveling adjustment switch	5-78
Wipers and washers	5-78
• Wipers	5-78
• Washers.....	5-80
Welcome system	5-81
• Illuminating functions.....	5-81
Interior lights	5-82
• Map lamp.....	5-82
• Room lamp.....	5-82
• Luggage room lamp	5-83
• Vanity mirror lamp	5-83
• Glove box lamp.....	5-83
Climate control system	5-84
Automatic climate control system	5-86
• Using the infotainment/climate switchable controller control panel.....	5-87
• Operating climate control system	5-88
• Controlling heating and air conditioning automatically.....	5-92
• Controlling temperature	5-92
• Adjusting driver and passenger side temperature equally.....	5-92
• Changing temperature scale	5-93
• Controlling fan speed.....	5-93
• Turning the fan OFF	5-93

5 Features of your vehicle

• Climate control features	5-93
Windshield defrosting and defogging.....	5-94
• Defrosting/defogging windshield	5-94
• Auto defogging for automatic climate control	5-94
• Rear window/outside mirror defroster	5-95
• Resetting defogging logic	5-95
Storage compartment	5-96
• Center console storage/glove box	5-96
• Luggage board.....	5-97
• Luggage net holder.....	5-97
• Cargo security screen	5-98
Interior features	5-99
• Ambient lights	5-99
• Cup holders	5-99
• Ashtray.....	5-100
• Seat warmer/ventilation.....	5-100
• Sun visor	5-101
• USB charger	5-102
• AC inverter	5-102
• Power outlet	5-103
• Wireless smart phone charging system.....	5-104
• Coat hook	5-106
• Floor mat anchors.....	5-106
Exterior features	5-107
• Roof rack	5-107
Infotainment system.....	5-108
• Using the infotainment/climate switchable controller	5-108
Audio system.....	5-109
• Antenna.....	5-109
• USB port.....	5-109
• How vehicle radio works.....	5-110

Features of your vehicle

* The information provided may differ according to which functions are applicable to your vehicle.

Keys

Record your key number

The key code number is stamped on the key code tag attached to the key set.

If you lose your keys, Kia recommends to contact an authorized Kia dealer/service partner.

Remove the key code tag and store it in a safe place. Also, record the key code number and keep it in a safe place (not in the vehicle).

Using the remote key (if equipped)



- 1 Lock button
- 2 Unlock button
- 3 Tailgate open/close button
- 4 Mechanical key release button

Operation

1. Press the corresponding button.
2. Fold the mechanical key while pressing the mechanical key release button (4).

Non-operating condition(s)

- The mechanical key is in the ignition switch.

- Exceeding the operating distance limit (approximately 10 m [30 ft.])
- The battery in the key is weak.
- Other vehicles or objects may be blocking the signal.
- The weather is extremely cold.
- The key is close to a radio transmitter, such as a radio station or an airport which can interfere with normal operation of the remote key.

* INFORMATION

- After pressing the lock/unlock button (1, 2) on the key, the hazard warning lights will blink.
- After pressing unlock button (2), the doors will lock automatically unless you open any door within 30 seconds.
- Press and hold the tailgate unlock button (3) to unlock the tailgate. The tailgate will lock automatically once the tailgate is opened and closed.
- If any door, hood or tailgate remains open, the hazard warning lights will not blink.

⚠ WARNING

- **Never leave the keys in your vehicle**
Leaving children unattended in a vehicle with the keys is dangerous even if the vehicle is ACC or ON position.
Unattended children could place the key in the ignition switch or press the ENGINE START/STOP button and may operate power windows or other controls, or even make the vehicle move, which could result in SERIOUS BODILY INJURY OR EVEN DEATH. Never leave the keys in your vehicle with unsupervised children, when the engine is running.

- Kia recommends to use parts for replacement from an authorized Kia dealer/service partner. If an aftermarket key is used, the vehicle may not return to ON after START. If this happens, the starter will continue to operate causing damage to the starter motor and possible fire due to excessive current in the wiring.

⚠ CAUTION

Do not fold the key without pressing the release button. This may damage the key.

*** NOTICE**

- Keep the remote key away from water or any liquid and fire. If the inside of the remote key gets damp (due to drinks or moisture), or is heated, internal circuit may malfunction, excluding the car from the warranty.
- Avoid dropping or throwing the remote key.
- Protect the remote key from extreme temperatures.
- When the remote key does not work correctly, open and close the door with the mechanical key. If you have a problem with the remote key, Kia recommends to contact an authorized Kia dealer/service partner.
- If the remote key is in close proximity to your cellular phone or smartphone, the signal from the transmitter could be blocked by normal operation of your cellular phone or smartphone. This is especially important when the phone is active such as making call, receiving calls, text messaging, and/or sending/receiving emails.

- Avoid placing the remote key and your cellular phone or smartphone in the same pants or jacket pocket and maintain adequate distance between the two devices.

Using the smart key (if equipped)



- 1 Lock button
- 2 Unlock button
- 3 Tailgate unlock/open button (if equipped)
- 4 Remote start button (if equipped)
- 5 Remote Start Parking Assist (Forward) button (if equipped)
- 6 Remote Start Parking Assist (Backward) button (if equipped)

Operation

- Press the corresponding button.

Non-operating condition(s)

- The key is close to a radio transmitter, such as a radio station or an airport which can interfere with normal operation of the smart key.
- Being near a mobile two-way radio system or a cellular phone.
- Another vehicle's smart key is being operated close to your vehicle.

* INFORMATION

- After pressing the lock/unlock button (1, 2) on the key, the hazard warning lights will blink.
- After pressing unlock button (2), the doors will lock automatically unless you open any door within 30 seconds.
- Press and hold the tailgate unlock/open button (3) to unlock or open the tailgate, according to the vehicle options. The tailgate will lock automatically once the tailgate is opened and closed.
- If any door, hood or tailgate remains open, the hazard warning lights will not blink.

* NOTICE

- If, for some reason, you happen to lose your smart key, you will not be able to start the vehicle. Tow the vehicle, if necessary, contact a professional workshop. Kia recommends to contact an authorized Kia dealer/service partner.
- A maximum of 2 smart keys can be registered to a single vehicle. If you lose a smart key, Kia recommends to contact an authorized Kia dealer/service partner.
- When the smart key does not work properly, open and close the door with the mechanical key. If you have a problem with the smart key, Kia recommends to contact an authorized Kia dealer/service partner.

Starting the vehicle remotely (if equipped)

Operation

1. Lock the doors by pressing the lock button (1) within 10 m (32 ft.) distance from the vehicle.
2. Within 4 seconds after locking the doors, press and hold the remote start button (4) for over 2 seconds.
3. Press the remote start button (4) again to turn off the vehicle.

* INFORMATION

If no further action for operating/driving the vehicle is taken, the vehicle will be turned off 10 minutes after starting the vehicle remotely.

Parking the vehicle remotely (if equipped)

Operation

1. Press the Remote Start Parking Assist (Forward) button (5) on the smart key to move the vehicle forward.
2. Press the Remote Start Parking Assist (Backward) button (6) on the smart key to move the vehicle backward.

* INFORMATION

For more information, refer to "Remote Smart Parking Assist (RSPA) (if equipped)" on page 6-155.

Removing the mechanical key from the smart key

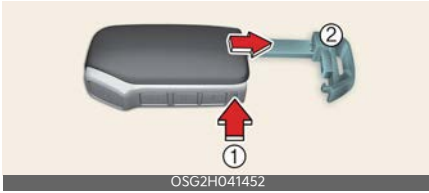

- 1 Tab
- 2 Mechanical key

Operation

1. Press and hold the tab (1).
2. Pull the mechanical key (2) out.

Replacing the key battery



Operation

1. Pry open the key cover gently.
2. Replace the old battery with a new battery.

⚠ WARNING

THIS PRODUCT CONTAINS A BUT-TON BATTERY

If swallowed, a lithium button battery can cause severe or fatal injuries within 2 hours.

Keep batteries out of reach of children. If you think batteries may have been swallowed or placed inside any part of the body, seek immediate medical attention.

*** INFORMATION**

The battery is CR2032 (3V).

⚠ WARNING

Leaving children unattended in a vehicle with the keys is dangerous even if the vehicle is ACC or ON position.

Unattended children could place the mechanical key in the ignition switch or press the ENGINE START/STOP button and may operate power windows or other controls, or even make the vehicle move, which could result in **SERIOUS BODILY INJURY OR EVEN DEATH**.

Never leave the keys in your vehicle with unsupervised children, when the engine is running.

⚠ CAUTION

- The remote key or smart key is designed to give you years of trouble-free use, however it can malfunction if exposed to moisture or static electricity. If you are unsure how to use or replace the battery, Kia recommends to contact an authorized Kia dealer/ service partner.
- Using the wrong battery can cause the remote key or smart key to malfunction. Be sure to use the correct battery.
- To avoid damaging the remote key or smart key, don't drop it, get it wet, or expose it to heat or sunlight.



- An inappropriately disposed battery can be harmful to the environment and human health. Dispose the battery according to your local law(s) or regulation.

* NOTICE

- If, for some reason, you happen to lose your smart key, you will not be able to start the vehicle. Tow the vehicle, if necessary, contact a professional workshop. Kia recommends to contact an authorized Kia dealer/service partner.
- A maximum of 2 smart keys can be registered to a single vehicle. If you lose a smart key, Kia recommends to contact an authorized Kia dealer/service partner.
- When the smart key does not work properly, open and close the door with the mechanical key. If you have a problem with the smart key, Kia recommends to contact an authorized Kia dealer/service partner.
- If the smart key is not moved for some time, the detection function for smart key operation will pause. Lift the smart key to activate the detection again (if equipped).

Theft-alarm system



The system provides an audible alarm and the hazard warning lights blink if triggered. The system is operated in 3 stages.

Armed stage

Operation

1. Lock the doors by pressing the lock button on the key or door handle.
2. The hazard warning lights will blink once to indicate that the system is armed.
3. The chime will sound for approximately 3 seconds if any doors remain open.

Operating condition(s)

- 30 seconds after all doors are closed and locked.
- Mechanical key is removed from the ignition switch.
- ENGINE START/STOP button is in the OFF position.

Theft-alarm stage

Operation

1. The horn will sound.
2. The hazard warning lights will blink continuously for approximately 30 seconds.
3. Unlock the doors with the key to turn off the system.

Disarmed stage

Operation

1. The hazard warning lights will blink twice after the doors are unlocked.

2. After pressing the door unlock button, if any door (or tailgate) is not opened within 30 seconds, the system will be rearmed.

Operating condition(s)

- Door unlock button is pressed.
- The button of the front outside door is pressed while carrying the smart key.
- The engine is started. (within 3 seconds)
- After pressing the unlock button, the hazard warning lights will blink and the chime will sound twice (in smart key) to indicate that the system is disarmed.
- After pressing the unlock button, if any door (or tailgate) is not opened within 30 seconds, the system will be rearmed.

CAUTION

- Do not attempt to alter this system or add other devices to it. Electrical problems could result that may make your vehicle inoperable.
- Do not change, alter or adjust the theft-alarm system because it could cause the theft-alarm system to malfunction. In this case, have the system serviced by a professional workshop. Kia recommends visiting an authorized Kia dealer/service partner. Malfunctions caused by improper alterations, adjustments or modifications to the theft-alarm system are not covered by your vehicle manufacturer warranty.
- Do not attempt to alter this system or add other devices to it. Electrical problems could result that may make your vehicle inoperable.

* NOTICE

- Avoid trying to start the engine while the alarm is activated. The vehicle starting motor is disabled during the theft-alarm stage.
- If the system is not disarmed with the remote key, insert the mechanical key into the ignition switch, turn the ignition switch to the ON position and wait for 30 seconds. Then the system will be disarmed.

Immobilizer system

The immobilizer system reduces the risk of unauthorized vehicle use.

It is comprised of a small transponder in the ignition switch and electronic devices inside the vehicle. It checks and determines and verifies if the ignition key is valid or not.

If the key is valid, the engine will start. If the key is invalid, the engine will not start.

Vehicles with the remote key

Operation

1. To deactivate the immobilizer system, insert the mechanical key into the ignition switch and turn to the ON position.
2. To activate the immobilizer system, turn the mechanical key to the OFF position.
3. The immobilizer system activates automatically. Without a valid remote key for your vehicle, the vehicle will not start.

Vehicles with the smart key (if equipped)

Operation

1. To deactivate the immobilizer system, press the ENGINE START/STOP button to the ON position.
2. To activate the immobilizer system, press the ENGINE START/STOP button to the OFF position.
3. The immobilizer system activates automatically. Without a valid smart key for your vehicle, the vehicle will not start.

⚠ WARNING

In order to prevent theft of your vehicle, do not leave spare keys anywhere in your vehicle. Your immobilizer password is a customer unique password and should be kept confidential. Do not leave this number anywhere in your vehicle.

⚠ CAUTION

- Do not put metal accessories near the ignition switch or the ENGINE START/STOP button. Metal accessories may interrupt the transponder signal and may prevent the vehicle from being started.
- The transponder in your key is an important part of the immobilizer system. It is designed to give years of trouble-free service, however you should avoid exposure to moisture, static electricity and rough handling. Immobilizer system malfunction could occur.
- Do not change, alter or adjust the immobilizer system because it could cause the immobilizer system to malfunction. In this case, have the system serviced by a professional workshop. Kia recommends visiting an authorized Kia dealer/service partner.
- Malfunctions caused by improper alterations, adjustments or modifications to the immobilizer system are not covered by your vehicle manufacturer warranty.
- Do not attempt to alter this system or add other devices to it. Electrical problems could result that may make your vehicle inoperable.

* NOTICE

- When starting the vehicle, do not use the key with other immobilizer keys around. Otherwise, the engine may not start or may stop soon after it starts. Keep each key separately in order to avoid a starting malfunction.
- If you need additional keys or lose your keys, Kia recommends visiting an authorized Kia dealer/service partner.

Door locks

Door locks outside the vehicle

Locking/unlocking with the smart key



Operation

1. Press the front door handle button (driver's side).
2. Hazard warning lights will blink and the chime will sound.
 - Locking: Once
 - Unlocking: Twice

Operating condition(s)

- All doors are closed
- Smart key is detected within 0.7~1 m (28~40 inches)

Non-operating condition(s)

- Smart key is in the vehicle.
- The vehicle is in ACC or ON position.
- Doors (except tailgate) is opened.

⚠ CAUTION

When leaving your vehicle with a smart key, be sure to close all doors (including hood and tailgate) and check by pressing the front door handle button. If the button is unpressed, the doors are unlocked.

*** NOTICE**

- After pressing the button, the doors will lock automatically unless you open any door within 30 seconds.
- By pulling the driver-side exterior door handle, you can find whether the door has locked or not.
- Make sure the doors are closed securely.
- If the door is locked/unlocked multiple times in rapid succession with either the vehicle key or door lock switch, the system may stop operating temporarily to protect the circuit and prevent damage to system components.
- Always place the ignition switch or ENGINE START/STOP button in the OFF position, engage the parking brake, close all windows, and lock all doors when leaving your vehicle unattended.
- If the Welcome Mirror/Light function is selected, the outside rear view mirror will automatically unfold when the doors are unlocked.

Limitation(s)

- Smart key is detected within 0.7~1 m (28~40 inches).

Locking/unlocking with the mechanical key



- 1 Tab
- 2 Cover

Operation

1. Pull the driver's side door handle, holding it in place.
2. Insert the key into the tab (1).
3. Lift the cover (2).
4. Turn the key.
 - Locking; Left
 - Unlocking; Right

⚠ WARNING

- If you don't close the door securely, the door may open again.
- Be careful that someone's body and hands are not trapped when closing the door.
- If people must spend a longer time in the vehicle while it is very hot or cold outside, there is risk of injuries or danger to life. Do not lock the vehicle from the outside when there are people in it.

⚠ CAUTION

Do not frequently repeat opening and closing of doors, or apply excessive force to a door while the door closer is operating.

*** NOTICE**

- When locking the door with a mechanical key, be aware that only the driver's door can be locked/unlocked.
- To lock all doors, operate the central lock switch inside the vehicle. Open the car door using the inner handle, then close the door and lock the driver's door with a mechanical key.
- Refer to "Door locks inside the vehicle" on page 5-14 to lock from inside the vehicle.

- Be careful not to lose or scratch the cover when removing it.
- When the key cover freezes and does not open, tap it lightly or indirectly warm (hand temperature, etc.) it up.
- Do not apply excessive force to the door and door handle. It may be damaged.
- If the door is locked/unlocked multiple times in rapid succession with either the vehicle key or door lock switch, the system may stop operating temporarily in order to protect the circuit and prevent damage to system components.

- Operate the door unlock feature repeatedly (both electronic and manual) while simultaneously pulling on the door handle.
- Operate the other door locks and handles, front and rear.
- Lower a front window and use the key to unlock the door from outside.
- Move to the cargo area and open the tailgate.
- Do not pull the inner door handle of driver's (or passenger's) door while the vehicle is moving.

Door locks inside the vehicle

Unlocking with the door handle



Operation

1. Front door

If the inner door handle is pulled once when the door is locked, the door will unlock and open.

2. Rear door

If the inner door handle is pulled once when the door is locked, the door will unlock. If the inner door handle is pulled once more, the door will open.

⚠ WARNING

- If a power door lock ever fails to function while you are in the vehicle, try one or more of the following techniques to exit:

Locking/unlocking with the central door lock switch



- 1 Door lock button
- 2 Door unlock button
- 3 Door indicator light

Operation

- Press the corresponding button below.
 - Switch (1): Lock
 - Switch (2): Unlock

*** INFORMATION**

- When all vehicle doors are locked, the door indicator light (3) on the driver's door and passenger's door will turn on. If any door is unlocked, it would go off.

- Any door is opened, the doors will not lock even though the central door lock switch is pressed.

WARNING

- The doors should always be fully closed and locked while the vehicle is in motion to prevent accidental opening of the door. Locked doors will also discourage potential intruders when the vehicle stops or slows down.
- Be careful when opening doors and watch for vehicles, motorcycles, bicycles or pedestrians approaching the vehicle in the path of the door. Opening a door when something is approaching can cause damage or injury.
- Leaving your vehicle unlocked can invite theft or possible harm to you or others from someone hiding in your vehicle while you are gone. Always remove the ignition key, engage the parking brake, close all windows and lock all doors when leaving your vehicle unattended.
- **Unattended children, the elderly or pets**

An enclosed vehicle can become extremely hot, causing death or severe injury such as heatstroke to unattended children, the elderly or pets who cannot escape the vehicle. When left or trapped in a hot vehicle, make sure to stay hydrated and avoid sun exposure through the vehicle's windshield. Furthermore, children might operate features of the vehicle that could injure them, or they could encounter other harm, possibly from someone gaining entry to the vehicle.

Never leave children or animals unattended in your vehicle.

Door lock features

Your vehicle is equipped with features that will automatically lock or unlock your vehicle based on settings you select in the cluster or infotainment system screen.

Auto lock enable on speed

When this feature is set in the cluster or infotainment system screen, all the doors will be locked automatically when the vehicle exceeds 15 km/h (9 mph).

Auto lock enable on shift

When this feature is set in the cluster or infotainment system screen, all the doors will be locked automatically when the vehicle is shifted out of P (Park) while the vehicle is running.

Auto unlock on shift to P

When this feature is set in the cluster or infotainment system screen, all the doors will be locked automatically when the vehicle is shifted out of P (Park) while the vehicle is running.

Auto unlock on vehicle off (if equipped)

When this feature is set in the cluster or infotainment system screen, all the doors will be unlocked automatically when the vehicle is turned off.

Impact sensing door unlock system (if equipped)

All doors will automatically unlock when an impact causes the air bags to deploy.

Speed sensing door lock system

All doors will automatically lock after the vehicle speed exceeds 15 km/h.

Deadlocks (if equipped)

Some vehicles are equipped with dead-lock system. Deadlocks prevent opening of a door from either inside or outside the vehicle once the dead-locks have been activated providing an additional measure of vehicle security.

To lock the vehicle using the dead lock function, the doors must be locked by using the smart key. To unlock the vehicle, the smart key must be used again.

Additional unlock safety feature air bag deployment

When this feature is set in the cluster or infotainment system screen, all the doors will be unlocked automatically when the vehicle is turned off.

Manual door lock switch



Operation

1. Open the door.
2. Insert the mechanical key.
3. Turn the key to the lock position.
4. Close the door securely.

Operating condition(s)

- The power door lock switch is not operating.

* NOTICE

If the electrical power to door lock switch is not operating (ex. dead car battery) and the tailgate is closed, you will not be

able to open the tailgate until power is restored.

Rear door locks

Child-protector rear door lock (if equipped)

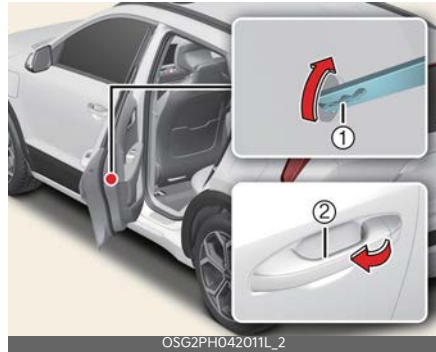

Operation

1. Insert the mechanical key.
2. Turn the child safety lock to the lock position (1).
3. To allow a rear door to be opened from inside the vehicle, unlock the child safety lock.
4. To open the rear door, pull the outside door handle (2).

Electronic child safety lock system (if equipped)



Operation

- Push the electronic child safety lock button.

* INFORMATION

- If you push the electronic child safety lock switch and the indicator appears, rear passengers cannot open the rear door from inside the vehicle
- Safe Exit Assist (SEA) does not automatically activate the electronic child safety lock system. If your vehicle is equipped with the Electronic child safety lock, the child-protector rear door locks, which are manually operated, are not provided.
- If 3 minutes passes after the EV button is pressed to the OFF or ACC position, the indicator on the button turns off, and the driver cannot turn off electronic child safety lock by pressing the button. To turn off the function, press the EV button to the ON position, and then press the electronic child safety lock button.

⚠ WARNING

If the Electronic child safety lock is not operated when pushing the Electronic child safety lock switch, the message is displayed and the alarm will sound.



A: Child safety lock error

If this occurs, have the system checked by a professional workshop.

Kia recommends to visit an authorized Kia dealer/service partner.

⚠ WARNING

- If children accidentally open the rear doors while the vehicle is in motion, they could fall out and be severely injured or killed. To prevent children from opening the rear doors from the inside, the rear door safety locks should be used whenever children are in the vehicle.
- The system does not detect every obstacle approaching the vehicle exit.
- The driver and passenger are responsible for the accident occurred while exiting the vehicle. Always check the surrounding before you exit the vehicle.

Rear Occupant Alert (ROA)

The Rear Occupant Alert (ROA) is provided to help prevent exiting the vehicle with a rear passenger left in the vehicle.

Operation

- Select **Convenience** → **Rear Occupant Alert** on the Settings menu.

Alert operation



A: Check rear seat for passengers and belongings

When you turn off the vehicle and open the driver's door after opening and closing the rear door or tailgate, the warning message appears on the cluster.

⚠ WARNING

Rear Occupant Alert provides information to the driver to check the rear seats but it does not detect whether there is an object or passenger in the back seats. Always make sure to check the rear seats before you leave the vehicle.

⚠ CAUTION

The door open and close history is initialized when the driver turns off the engine and locks the vehicle door. Even though the rear door is not opened again, an alert may occur if the previous history is not initialized. For example, if driver does not lock the vehicle door and opens the door to get off after the alert sounds, the alert may go off.

Driver position memory system (if equipped)**Setting memory position****Operation**

1. Adjust the following position:
 - Driver's seat position
 - Outside mirror position (if equipped)
 - Head-up display (HUD) (if equipped)
2. After then, press '1' or '2' button.
 - Press and hold about 1 second.
 - The system will beep twice and notify you.
 - 'Driver 1 (or 2) settings saved' will appear on the infotainment screen.

*** INFORMATION**

The vehicle should be in the ON position to use this function.

Recalling memory position**Operation**

1. Press the '1' or '2' button.
 - The system will beep once.
2. After then, stored positions will be adjusted.
3. 'Driver 1 (or 2) settings applied' will appear on the infotainment screen.

Non-operating condition(s)

- When driving speed exceeds 3 km/h (2 mph).

Resetting the driver position memory system

Operation

1. The vehicle is in the ON position and the vehicle gear is in P (Park).
2. Move the driver seat as forward as possible.
3. Move the seatback to a fully upright position.
4. After then, press the '1' button and seat forward movement switch simultaneously for approximately 2 seconds.

Initialization

1. Open the driver's door.
2. The seat and seatback will move backwards.
 - The beep will sound continuously.
3. The seat and seatback will move to the center position.
 - The beep sound will stop.

Easy access function

Operating condition(s)

- Driver's seat moves backward when:
 - The vehicle is in OFF position
 - The driver door is opened
- Driver's seat moves forward when:
 - The vehicle is in ACC or ON position
 - The driver door is closed when you have the smart key with you.

* INFORMATION

You can activate or deactivate the Easy Access Function from the Settings menu.

⚠ WARNING

Never attempt to operate the driver position memory system while the vehicle is moving. This could result in loss of control, and an accident causing death, serious injury, or property damage.

* NOTICE

- If the battery is disconnected, the memory settings will be erased.
- If the Driver Position Memory System does not operate normally, we recommend that you have the system checked by an authorized Kia dealer/service partner.

Tailgate

Opening/closing the manual tailgate



Operation

1. Press the outside handle switch (1) to open the tailgate.
2. Pull up the tailgate.
3. Push down the tailgate to close it.
Make sure that the tailgate is securely latched.

Operating condition(s)

- The tailgate is locked or unlocked using the key or central door lock switch.

Power tailgate (if equipped)

Operating the power tailgate



Operation

- 1 Press the power tailgate open/close button inside the vehicle or with the smart key for 1 second. The power tailgate opens with a warning sound. Press and hold the power tailgate open/close button inside the vehicle or with the smart key to close the tailgate.
 - While the tailgate is opening, press the power tailgate open/close button again to stop tailgate operation.
 - If you release the power tailgate open/close button while the tailgate is closing, or the smart key is not within operation range (approximately 10 m (33 ft.)) from the vehicle, power tailgate operation will stop with a warning sound for 5 seconds.

- 2 The tailgate will open or close with a warning sound when the power tailgate open/close button outside the vehicle.
If the vehicle is locked, press the power tailgate open/close button outside the vehicle with the smart key in your possession.
- 3 Press the power tailgate open/close button inside the tailgate. The tailgate opens or closes with a warning sound.

Operating condition(s)

- When the gear is in P (Park) with the vehicle in ON position
- When the vehicle is in OFF position

Non-operating condition(s)

- The vehicle speed is above 3 km/h (1.8 mph)

Automatic reverse

If the power tailgate senses any obstacle, the tailgate will stop or will fully open.

Operating condition(s)

- If the power tailgate senses any obstacles

Non-operating condition(s)

- If the detected resistance is below a certain level
- If the tailgate is almost fully closed near the latched position
- If a strong impact is applied with no obstructions placed

⚠ WARNING

- Never leave children or animals unattended in your vehicle. Children may operate the power tailgate. Doing so can result in injury to themselves or others and can damage the vehicle.
- Make sure that there are no people or objects in the path of the power tailgate or smart tailgate prior to use. Serious injury, damage to the vehicle or damage to surrounding objects (for example, walls, ceilings, vehicles, etc.) may result if contact with the tailgate occurs.



- A: 70 cm
- B: 70 cm

- Never intentionally place any object or part of your body in the path of the power tailgate to make sure the automatic reverse feature operates. Serious injury, or damage to the vehicle or object may occur.

⚠ CAUTION

- For safety, apply the parking brake and operate when in the N (Neutral) position.
- Do not close or open the tailgate manually. This may cause damage to the power tailgate. If it is necessary to close or open the tailgate manually when the battery is discharged or disconnected, do not apply excessive force.

- Do not operate the power tailgate more than 10 times continuously when the engine is not running. Use the power tailgate with the engine running when the power tailgate is used repeatedly to prevent battery discharge.
- Do not leave the power tailgate open for a long period of time. This may drain the battery.
- Do not apply excessive force when the power tailgate is operating. Doing so could result in vehicle damage.
- Do not grab or hold on to the tailgate support struts at any time. Damage to the tailgate support struts could result. Deformation of the tailgate support struts may cause vehicle damage and personal injury may occur.



OSG2H041514

- Do not modify or repair any part of the power tailgate by yourself. This must be done by an authorized Kia dealer/service partner.
- Do not operate the power tailgate under the following conditions. The power tailgate may not operate properly.
 - One side of the vehicle is lifted to inspect the vehicle or change a tire
 - Parking on an uneven road such as a slope, etc.
- Close the tailgate completely and lock all doors and tailgate using the central door lock button before using an automatic car wash.

- Do not spray high pressure water directly on the power tailgate outside open/close button. The tailgate may open unintentionally.

*** NOTICE**

- If the tailgate is not fully closed and vehicle speed is at or above 3 km/h (1.8 mph), a warning will sound 10 times. Immediately park the vehicle at a safe place, close the tailgate, and check that the tailgate open warning on the instrument cluster is turned off.
- In cold and wet climates, the outside power tailgate open/close button may not work properly due to freezing conditions. If this occurs, remove the ice before using the outside power tailgate open/close button or use the power tailgate open/close button on the smart key or the instrument panel.
- Operating the power tailgate more than 5 times continuously could cause damage to the operating motor. If this occurs, the power tailgate will not operate to prevent the motor from overheating. If any of the power tailgate buttons are pressed to try to open the tailgate, the chime will sound 3 times, but the tailgate will remain closed. Allow the power tailgate system to cool for about 1 minute before operating the system again.
- The power tailgate may stop operating if the automatic reverse feature operates more than two times while attempting to open or close the tailgate. If this occurs, carefully open or close the tailgate manually, and then after 30 seconds try to operate the power tailgate automatically again.

Setting the power tailgate

Power tailgate opening speed

You can adjust the power tailgate opening speed. Select the desired opening speed (**Fast / Slow**) (Default setting is **Fast**).

Operation

- **Instrument cluster (if equipped)**
Select **Settings** → **Door** → **Power Tailgate Opening Speed** → **Fast / Slow**.
- **Infotainment system (if equipped)**
Select **Settings** → **Vehicle** → **Door** → **Power Tailgate Opening Speed** → **Fast / Slow**.

Power tailgate opening height

You can adjust the power tailgate opening height. Select the desired opening height (**Full Open / Level 3 / Level 2 / Level 1 / User Height Setting**).

Operation

- **Instrument cluster (if equipped)**
Select **Settings** → **Door** → **Power Tailgate Opening Height** → **Full Open / Level 3 / Level 2 / Level 1 / User Height Setting**.
- **Infotainment system (if equipped)**
Select **Settings** → **Vehicle** → **Door** → **Power Tailgate Opening Height** → **Full Open / Level 3 / Level 2 / Level 1 / User Height Setting**.

User height setting

Operation

1. Position the tailgate manually to the height you prefer.

2. Press the power tailgate open/close button located inside the tailgate for more than approximately 3 seconds.
If **User Height Setting** is selected for the power tailgate opening height, the power tailgate will automatically open to the height manually set by you.

* INFORMATION

- The infotainment system may change after updates. For detailed information on system settings, see the infotainment system web manual.
- To use each feature, you must select the opening speed or opening height from the settings menu. Deselect the settings when you do not want to use the feature.
- If the power tailgate opening height has not been manually set, the power tailgate will fully open when 'User Height Setting' from the infotainment system is selected.
- If one of the height setting (**Full Open / Level 3 / Level 2 / Level 1 / User Height Setting**) is selected from the settings menu in the infotainment system, and then 'User Height Setting' is selected, the tailgate will open to the height manually set by you.
- The power tailgate opening speed and opening height settings change according to the linked User Profile. If the User Profile is changed, power tailgate opening speed and opening height settings will change accordingly.

Resetting the power tailgate

Operation

1. With the vehicle in OFF or ON position, shift to P (Park).
2. Press the power tailgate open/close button inside the tailgate and the power tailgate open/close button outside the vehicle simultaneously until a chime sounds.



3. Slowly close the tailgate manually.
4. Press the power tailgate open/close button outside the vehicle. The power tailgate will open with a chime sound.

* NOTICE

- In some circumstances resetting the power tailgate operation may need to be performed. Some instances where resetting the power tailgate may be required include:
 - When the 12-volt battery is recharged
 - When the 12-volt battery is reinstalled after removal or replacement
 - When the related fuse is reinstalled after removal or replacement
- Wait until the tailgate fully opens to complete resetting. If the tailgate

stops before it is fully open, resetting cannot be completed.

- If the power tailgate does not operate properly after the above procedure, we recommend the system inspected by an authorized Kia dealer/service partner.

Emergency tailgate safety release



Operation

1. Insert a long, flat object, such as a key into the opening at the bottom of the tailgate.
2. Slide the latch in the direction of the arrow to unlock the tailgate.
3. Push the tailgate to open.

⚠ WARNING

- For emergencies, be fully aware of the location of the emergency tailgate safety release latch in the vehicle and how to open the tailgate if you are accidentally locked in the luggage compartment.
- No one, including animals, should be allowed to occupy the luggage compartment of the vehicle at any time. The luggage compartment is a very dangerous location in the event of an accident.
- Use the release latch for emergencies only. Use extreme caution, especially while the vehicle is in motion.

Opening the smart tailgate (if equipped)



Operation

- Select **Door** → **Smart tailgate** from the Settings menu.

Operating condition(s)

- After 15 seconds when all doors are closed and locked.
- Positioned in the detecting area for more than 3 seconds.
- Disconnecting the charging connector

Non-operating condition(s)

- The smart key is detected less than 15 seconds after the doors are closed and locked and is continuously detected.
- The smart key is detected less than 15 seconds after the doors are closed and locked and 1.5 m from the front door handles (for vehicles equipped with Welcome Light).
- A door is not locked or closed.
- The smart key is in the vehicle.
- The vehicle is on charge

Limitation(s)

- Smart key is not detected within 50~100 cm (28~40 inches) radius behind the vehicle

Detect and Alert

Operation

1. The hazard warning lights will flash.
2. The alarm will sound when the smart key is detected.

Automatic opening

Operation

1. The tailgate will open.
2. The hazard warning lights will flash.
3. The alarm will sound 6 times.

Deactivating smart tailgate with smart key

Operation

1. Press any of the following smart key buttons during "Detect and Alert" stage to deactivate the function.
 - Door lock button
 - Door unlock button
 - Tailgate open/close button

* NOTICE

- If you press the door unlock button, the Smart Tailgate with Auto Open function will be deactivated temporarily. But, if you do not open any door for 30 seconds, the Smart Tailgate with Auto Open function will be activated again.
- If you press the tailgate open button for more than 1 second, the tailgate opens.
- If you press the door lock button or tailgate open button when the Smart Tailgate with Auto Open function is not in the Detect and Alert stage, the Smart Tailgate with Auto Open function will not be deactivated.

- In case you have deactivated the Smart Tailgate with Auto Open function by pressing the smart key button and opened a door, the Smart Tailgate with Auto Open function can be activated again by closing and locking all doors.

Non-operating condition(s)

- The smart key is close to a radio transmitter such as a radio station or an airport, which can interfere with the normal operation of the smart key.
- The smart key is near a mobile two-way radio system or a cell phone.
- Another vehicle's smart key is being operated close to your vehicle.
- The detecting range may decrease or increase when:
 - One side of the vehicle is raised to replace a tire or to inspect the vehicle.
 - The vehicle is parked at a slant on a slope, an unpaved road, etc.

⚠ WARNING

- Make sure you close the tailgate before driving your vehicle.
- Make sure there are no people or objects around the tailgate before opening or closing the tailgate.
- Make sure objects in the tailgate do not come out when opening the tailgate on a slope. It may cause serious injury.
- Make sure to deactivate the Smart Tailgate with Auto Open when washing your vehicle. Otherwise, the tailgate may open inadvertently.
- The key should be kept out of reach of children. Children may inadver-

tently open the Smart Tailgate with Auto Open while playing around the rear area of the vehicle.

⚠ CAUTION

Do not approach the detecting area if you do not want the tailgate to open. If you have unintentionally entered the detecting area and the hazard warning lights and chime starts to operate, leave the detecting area with the smart key. The tailgate will stay closed.

* NOTICE

- If the power tailgate opening height is set manually, and then **User height setting** is selected from the Settings menu, the power tailgate will automatically open to the height manually set by the driver.
- If the power tailgate opening height has not been manually set, the power tailgate will fully open when **User height setting** from the Settings menu is selected.
- If one of the height (**Full open /Level 3 /Level 2 /Level 1**) is selected from the Settings menu, and then **User height setting** is selected, the power tailgate open height will be set to the previously saved height.

Tailgate emergency safety release



Operation

1. Insert the mechanical key into the keyhole.
2. Move the mechanical key to the right (1).
3. Push the tailgate upward.

⚠ WARNING

- For emergencies, be fully aware of the location of the emergency tailgate safety release lever in the vehicle and how to open the tailgate if you are accidentally locked in the luggage compartment.
- No one should be allowed to occupy the cargo area of the vehicle at any time. The cargo area is a very dangerous location in the event of a crash.
- Use the release lever for emergencies only. Use with extreme caution, especially while the vehicle is in motion.
- Do not grasp the part supporting the tailgate (gas lifter), as this may cause serious injury.



Windows

Left-hand drive



OSG2PH042001L_4

Right-hand drive



- 1 Driver's door power window switch
- 2 Front passenger's door power window switch
- 3 Rear door (left) window switch
- 4 Rear door (right) window switch
- 5 Power window lock switch

Controlling power windows switch



- Type A: 1
- Type B: 1, 2 (if equipped)

Operation

- Press or pull the switch to the first/second detent position (1, 2).

* INFORMATION

Only type B can use auto up/down function.

Operating condition(s)

- The vehicle is in the ON position.

⚠ WARNING

Do not install any accessories in the area of windows. It may impact jam protection.

* NOTICE

- While driving with the rear windows down or with the sunroof (if equipped) in an open (or partially open position), your vehicle may demonstrate a wind buffeting or pulsation noise. This noise is a normal occurrence and can be reduced or eliminated by taking the following actions. If the noise occurs with one or both of the rear windows down, partially lower both front windows approximately 2.5 cm (1 inch). If you

experience the noise with the sunroof open, slightly reduce the size of the sunroof opening.

- In cold and wet climates, power windows may not work properly due to freezing conditions.

Resetting power windows

Operation

1. Close the window.
 - Approximately 1 second
2. Pull the power window switch.

Operating condition(s)

- The vehicle is in the ON position.

Power windows automatic reversal (if equipped)

Operation

1. Windows will stop and move down.
 - Approximately 30 cm (12 inches)
2. Windows will move down.
 - Approximately 2.5 cm (1 inch)

Operating condition(s)

- Object or part of the body is detected
- Force is detected

⚠ WARNING

- Always check for obstructions before raising any window to avoid injuries or vehicle damage. If an object less than 4 mm (0.16 inch) in diameter is caught between the window glass and the upper window channel, the automatic reverse window may not detect the resistance and will not stop and reverse direction.

- The automatic reverse feature is not activated while resetting power window system. Make sure body parts or other objects are safely out of the way before closing the windows to avoid injuries or vehicle damage.

*** NOTICE**

The automatic reverse feature for the window is only active when the "auto up" feature is used by fully pulling up the switch. The automatic reverse feature will not operate if the window is raised using the halfway position on the power window switch.

Power windows lock button



OSG2H041070

Operation

1. Push the power windows lock button.
 - Rear passenger window is inoperable.
2. The front driver and passenger window can be operated.

WARNING

- NEVER leave the keys in your vehicle with unsupervised children, when the engine is running.
- NEVER leave any child unattended in the vehicle. Even very young children may inadvertently cause the vehicle to move, entangle themselves in the windows, or otherwise injure themselves or others.

- Always double check to make sure all arms, hands, head and other obstructions are safely out of the way before closing a window.
- Do not allow children play with the power windows. Keep the driver's door power window lock button in the LOCK position (pressed). SERIOUS INJURY can result from unintentional window operation by the child.
- Do not extend heads or any limbs outside the window while the vehicle is in motion.

CAUTION

- To prevent possible damage to the power window system, do not open or close two windows or more at the same time. This will also ensure the longevity of the fuse.
- Never try to operate the main switch on the driver's door and the individual door window switch in opposite directions at the same time. If this is done, the window will stop and cannot be opened or closed.

Remote window closing/opening (for front seats) (if equipped)



ONQ5031141L_2

- 1 Lock button

2 Unlock button

If Auto window up/down function (safety window function) is equipped, you can still control the corresponding windows movement with engine turned off.

Operation

1. Press and hold the door lock button (1) on the smart key to close the windows. The windows will move up as long as the button is pressed.
2. Press and hold the door unlock button (2) on the smart key to open the windows. The windows will move down as long as the button is pressed.
3. Remote window operation can be activated or deactivated from the Settings menu.

WARNING

- Do not install any accessories in the area of windows. It may impact jam protection.
- Always check for obstructions before raising any window to avoid injuries or vehicle damage. If an object less than 4 mm (0.16 inches) in diameter is caught between the window glass and the upper window channel, the automatic reverse window may not detect the resistance and will not stop and reverse direction.
- The automatic reverse feature is not activated while resetting power window system. Make sure body parts or other objects are safely out of the way before closing the windows to avoid injuries or vehicle damage.
- NEVER leave the keys in your vehicle with unsupervised children, when the vehicle is running.
- NEVER leave any child unattended in the vehicle. Even very young children

may inadvertently cause the vehicle to move, entangle themselves in the windows, or otherwise injure themselves or others.

- Always double check to make sure all arms, hands, head and other obstructions are safely out of the way before closing a window.
- Do not allow children play with the power windows. Keep the driver's door power window lock button in the LOCK position (pressed). SERIOUS INJURY can result from unintentional window operation by the child.
- Do not extend heads or any limbs outside the window while the vehicle is in motion.
- Make sure body parts of other objects are safely out of the way before remote closing the windows to avoid injuries or vehicle damage.

CAUTION

- To prevent possible damage to the power window system, do not open or close two windows or more at the same time. This will also ensure the longevity of the fuse.
- Never try to operate the main switch on the driver's door and the individual door window switch in opposite directions at the same time. If this is done, the window will stop and cannot be opened or closed.

NOTICE

- While driving with the rear windows down or with the sunroof (if equipped) in an open (or partially open position), your vehicle may demonstrate a wind buffeting or pulsation noise. This noise is a normal

occurrence and can be reduced or eliminated by taking the following actions. If the noise occurs with one or both of the rear windows down, partially lower both front windows approximately one inch. If you experience the noise with the sunroof open, slightly reduce the size of the sunroof opening.

- In cold and wet climates, power windows may not work properly due to freezing conditions.
- The automatic reverse feature for the window is only active when the "auto up" feature is used by fully pulling up the switch. The automatic reverse feature will not operate if the window is raised using the halfway position on the power window switch.

Hood

Opening the hood



- 1 Hood release lever
- 2 Hood secondary latch
- 3 Hood

Operation

1. Pull the hood release lever (1).
2. Push the secondary latch (2) to the left.
3. Lift the hood (3) upwards.
4. Go to the front of the vehicle, raise the hood slightly, push the secondary latch (2) to the left and lift the hood.

⚠ WARNING

- Open the hood after turning off the engine on a flat surface, shifting the gear to the P (Park) position and setting the parking brake.
- Grasp the support rod in the area wrapped in rubber. The rubber will help prevent you from being burned by hot metal when the engine is hot.
- The support rod must be inserted completely into the hole provided in the hood whenever you inspect the engine compartment. This will prevent

the hood from falling and possibly injuring you.

Closing the hood



- Always double check to be sure that the hood is firmly latched before driving away. If it is not latched, the hood could open while the vehicle is being driven, causing total loss of visibility, which might result in an accident.
- Do not move the vehicle with the hood raised. The view will be blocked and the hood could fall or be damaged.

Operation

1. Before closing the hood, check the following:
 - All filler caps in the engine compartment must be correctly installed.
 - Gloves, rags or any other combustible material must be removed from the engine compartment.
2. Lower the hood until it is about 30 cm (12 inches) above the closed position and let it drop. Make sure that it locks into place.
3. Check that the hood has engaged properly.
 - If the hood can be raise slightly, it is not properly engaged.
 - Open it again and close it with a little more force.

WARNING

- Before closing the hood, ensure that all obstructions are removed from the hood opening. Closing the hood with an obstruction present in the hood opening may result in property damage or severe personal injury.
- Do not leave gloves, rags or any other combustible material in the engine compartment. Doing so may cause a heat-induced fire.

Fuel filler door

Opening the fuel filler door (Hybrid vehicle)



- 1 Fuel filler door
- 2 Fuel tank cap

Operation

1. Turn the engine off.
2. Ensure all the doors are unlocked.
3. Press the rear center edge to open the fuel filler door (1).
4. Remove the fuel tank cap (2) by turning it counterclockwise.
5. Place the cap on the fuel filler door.

⚠ WARNING

Before refueling, be sure to check what type of fuel is used for your vehicle.

If you put diesel fuel into a gasoline-powered vehicle or gasoline into a diesel-powered vehicle, it may affect the fuel system and cause serious damage to the vehicle.

*** NOTICE**

- The fuel filler door will unlock when driver's door is unlocked.
To unlock fuel filler door:
 - Press the unlock button on your smart key.
 - Press the central door unlock button on armrest trim of driver's door.

- Pull the driver's inside door handle outward.

The fuel filler door will lock when all doors are locked.

To lock fuel filler door:

- Press the lock button on your smart key.
- Press the central door lock button on armrest trim of driver's door.

* All doors will automatically lock after the vehicle speed exceeds 15 km/h (9.3 mph). Fuel door is also locked when vehicle speed exceeds 15 km/h (9.3 mph).

- If the fuel filler door does not open because ice has formed around it, tap lightly or push on the door to break the ice and release the door. Do not pry on the door. If necessary, spray around the door with an approved de-icer fluid (do not use radiator anti-freeze) or move the vehicle to a warm place and allow the ice to melt.

Opening the fuel filler door (Plug-in hybrid vehicle)

1. Stop the engine. To open the fuel filler door, push the fuel filler door opener button.



2. Wait until the fuel tank is depressurized. The message is displayed when the fuel filler door unlocks after the fuel tank is depressurized.



A: Unlocking fuel door...

- The fuel door is unlocked when the message is displayed.

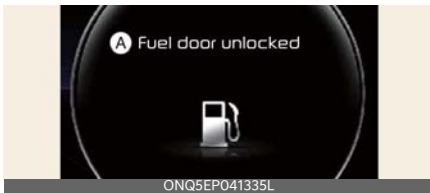

A: Fuel door unlocked

- When the fuel door is open, a message is displayed.

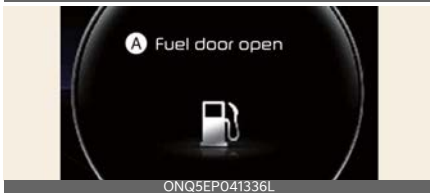

A: Fuel door open

- Pull open the fuel filler door (1).
To remove the cap, turn the fuel filler door cap (2) counterclockwise.
Refuel as needed.



*** NOTICE**

- It may take up to 20 seconds to unlock fuel filler door.
- If the fuel filler door does not open because ice has formed around it, tap lightly or push on the door to break the ice and release the door.
- Do not pry on the door. If necessary, spray around the door with an approved de-icer fluid (do not use radiator anti-freeze) or move the vehicle to a warm place and allow the ice to melt.

⚠ WARNING

Before refueling, be sure to check what type of fuel is used for your vehicle. If you put diesel fuel into a gasoline-powered vehicle or gasoline into a diesel-powered vehicle, it may affect the fuel system and cause serious damage to the vehicle.

⚠ WARNING

- Add fuel into the fuel tank within 20 minutes after opening the fuel filler door. After 20 minutes, the fuel tank may shut off, causing fuel to overflow. In this case, re-press the fuel filler door opening button.
- Do not leave the fuel filler door opened for an extended period of time. It may discharge the battery.
- Close the fuel filler door after fueling the vehicle. If you start the vehicle

with the fuel filler door opened, "Check fuel door" message appears on the LCD display.

- Avoid refueling the vehicle while charging the (high-voltage) hybrid battery. It may cause a fire or an explosion due to static electricity.

Closing the fuel filler door

Operation

1. Turn the fuel tank cap (2) clockwise until it "clicks".
2. Press the rear center edge to close the fuel filler door (1).
3. Ensure all the doors and the fuel filler door are locked.

WARNING

Automotive fuels are flammable materials. When refueling, please note the following guidelines carefully. Failure to follow these guidelines may result in severe personal injury, severe burns or death by fire or explosion.

- Read and follow all warnings posted at the gas station.
- Before refueling, note the location of the Emergency Gasoline Shut-Off, if available, at the gas station.
- Before touching the fuel nozzle, you should eliminate the potential build-up of static electricity by touching a metal part of the vehicle, a safe distance away from the fuel filler neck, nozzle, or other gas source, with your bare hand.
- Do not use cellular phones while refueling. Electric current and/or electronic interference from cellular phones can potentially ignite fuel vapors and cause a fire.
- Do not get back into a vehicle once you have begun refueling. You can generate a build-up of static electricity by touching, rubbing or sliding against any item or fabric capable of producing static electricity. Static electricity discharge can ignite fuel vapors causing a fire. If you must re-enter the vehicle, you should once again eliminate potentially dangerous static electricity discharge by touching a metal part of the vehicle, away from the fuel filler neck, nozzle or other gasoline source, with your bare hand.
- When refueling, always shift the gear to the P (Park) position, set the parking brake, and place the ignition switch or ENGINE START/STOP button to the LOCK/OFF position.
- Sparks produced by electrical components related to the engine can ignite fuel vapors causing a fire.
- When using an approved portable fuel container, be sure to place the container on the ground prior to refueling. Static electricity discharge from the container can ignite fuel vapors causing a fire. Once refueling has begun, contact between your bare hand and the vehicle should be maintained until the filling is complete.
- Use only approved portable plastic fuel containers designed to carry and store gasoline.
- Do not use matches or a lighter and do not smoke or leave a lit cigarette in your vehicle while at a gas station, especially during refueling.
- Do not over-fill or top-off your vehicle tank, which can cause gasoline spillage.
- If a fire breaks out during refueling, leave the vicinity of the vehicle, and

immediately contact the manager of the gas station and then contact the local fire department. Follow any safety instructions they provide.

- If pressurized fuel sprays out, it can cover your clothes or skin and thus subject you to the risk of fire and burns. Always remove the fuel cap carefully and slowly. If the cap is venting fuel or if you hear a hissing sound, wait until the condition stops before completely removing the cap.
- Always check that the fuel cap is installed securely to prevent fuel spillage in the event of an accident.
- In case of using EV drive mode for a certain time without running engine, EMM (Engine Maintenance Mode) will automatically activate by the system to protect the fuel system and the engine.

Therefore, even though if it is possible to use EV drive mode with enough battery power, the engine may run by the system to protect fuel system and the engine.

If you leave the fuel without refueling or using for over 6 months, the remained fuel in the fuel system may be deteriorated. From this corrosion or blocking problem may occur.

It is recommended using minimum 40 % of remained fuel at least every 6 months by selecting Hybrid (CS) mode and refuel the vehicle with new fuel.

* NOTICE

- Make the vehicle door to LOCK position when the fuel filler door is completely closed in order to lock the fuel filler door. If the fuel filler door is not completely closed, the fuel filler door will not be locked.
- Make sure to refuel your vehicle according to the fuel requirements.
- Do not spill fuel on the exterior surfaces of the vehicle. Any type of fuel spilled on painted surfaces may damage the paint.
- If the fuel filler cap requires replacement, use only Kia Genuine Parts or those of an equivalent standard for your vehicle. An incorrect fuel filler cap can result in a serious malfunction of the fuel system or emission control system.
- After refueling, make sure the fuel cap is installed securely to prevent fuel spillage in the event of an accident.

⚠ CAUTION

Keep the door into LOCK position when the vehicle is being washed (i.e. high pressure washer, automatic car washer, etc.)

Sunroof (if equipped)

If your vehicle is equipped with a sunroof, you can slide or tilt your sunroof with the sunroof switch located on the overhead console.



OSG2H041071

The sunroof can only be operated when the ignition switch or ENGINE START/STOP button is in the ON or START position.

The sunroof can be operated for approximately 3 minutes after the ignition switch or Engine Start/Stop button is in the ACC or LOCK/OFF position.

However, if the front door is open, the sunroof cannot be operated even within the 3 minutes period.

⚠ WARNING

- Adjust the sunroof or sunshade when your vehicle stops. This could result in loss of control and an accident that may cause injury, or property damage.
- Do not leave the engine running and the key in your vehicle with unsupervised children. Unattended children could operate the sunroof, which could result in serious injury.
- Do not sit on the top of the vehicle. It may cause injury or vehicle damage.

*** NOTICE**

Do not operate the sunroof when roof bars are installed on the vehicle or when there is luggage on the roof.

Sunshade



OSG2H041064

Use the sunshade to block direct sunlight coming through the sunroof glass. Open or close the sunshade by hand.

*** INFORMATION**

The sunshade opens automatically when the sunroof glass is opened, but the sunshade does not close automatically when the sunroof glass is closed. Also, only the sunshade cannot be closed when the sunroof glass is opened.

*** NOTICE**

Do not pull the sunshade up or down, or apply excessive force as such action may damage the sunshade or cause it to malfunction.

Tilt open/close



OSG2H041527_3

1 Tilt open

2 Tilt close

- Push the sunroof switch upward, the sunroof glass tilts open.

- Push the sunroof switch forward when the sunroof glass is tilt opened, the sunroof glass closes.

The sunroof glass tilts open or closes while the switch is pushed.

*** INFORMATION**

The sunroof glass cannot slide open and tilt open at the same time. You cannot tilt the sunroof glass open while the sunroof glass is slide open. Also, you cannot slide the sunroof glass open while the sunroof is tilt open. Slide open or tilt open the sunroof glass when the sunroof glass is completely closed.

Slide open/close



- Push the sunroof switch rearward, the sunshade and sunroof glass slide open.
Push the sunroof switch forward, only the sunroof glass closes.
- Push the sunroof switch forward or rearward to the first detent position, the sunroof glass moves until the switch is released.
- Push the sunroof switch forward or rearward to the second detent position, the sunroof glass operates automatically (auto slide feature). To stop the sunroof movement at any point, push the sunroof switch in any direction.
- The sunroof glass stops halfway (first detent position) before it is fully opened. To fully open the sunroof

glass, push the sunroof switch rearward once more. At this time, the sunroof glass opens only while the switch is pushed.

*** INFORMATION**

To reduce wind noise while driving, we recommend that you drive at the recommended position (first detent position) before the maximum slide open position.

Automatic reversal



If the sunroof glass senses any obstacle while it is closing automatically, it will reverse direction then stop at a certain position.

The auto reverse function may not work if an object thin or soft is caught between the sliding sunroof glass and sunroof sash.

⚠ WARNING

- Make sure heads, hands, arms or any other body parts or objects are out of the way before operating the sunroof. Body parts or objects may get caught causing injuries or vehicle damage.
- Never deliberately use your body parts to test the automatic reversal function. The sunroof glass may reverse direction, but there is a risk of injury.

* NOTICE

- Do not continue to push the sunroof switch after the sunroof is fully opened, closed, or tilted. Damage to the sunroof motor could occur.
- Continuous operations such as slide open/close, tilt open/close, etc. may cause the motor or sunroof system to malfunction.
- Regularly remove any accumulated dust on the sunroof rail.
- Dust accumulated between the sunroof and roof panel can make noise. Open the sunroof and remove dust regularly using a clean cloth.
- Do not try to open the sunroof when the temperature is below freezing or when the sunroof is covered with snow or ice. The sunroof may not work properly and may break if opened by force.
- Do not open or drive with the sunroof glass open immediately after rain or washing the vehicle. Water may wet the interior of the vehicle.
- Do not extend any luggage outside the sunroof while driving. Vehicle damage may occur if the vehicle suddenly stops.

▲ WARNING

Do not extend your head, arms, body parts or objects outside the sunroof while driving. Injuries may occur if the vehicle suddenly stops.

Resetting the sunroof



In some circumstances resetting the sunroof operation may need to be performed. Some instances where resetting the sunroof may be required include:

- When the 12-volt battery is either disconnected or discharged
- When the sunroof fuse is replaced
- If the sunroof one-touch AUTO OPEN/CLOSE operation is not functioning properly

Sunroof resetting procedure:

1. It is recommended to perform the reset procedure with the vehicle engine running. Start the vehicle in P (Park).
2. Make sure the sunroof glass is in the fully closed position. If the sunroof glass is open, push the switch forward until the sunroof glass is fully closed.
3. Release the switch when the sunroof glass is fully closed.
4. Push the switch forward until the sunroof glass moves slightly. Then release the switch.
5. Once again push and hold the sunroof switch forward until the sunroof glass slides open and close. Do not release the switch until the operation is completed.

If you release the switch during operation, start the procedure again from step 2.

* INFORMATION

If the sunroof does not reset when the vehicle battery is disconnected or discharged, or the sunroof fuse is blown, the sunroof may not operate normally.

Sunroof open warning

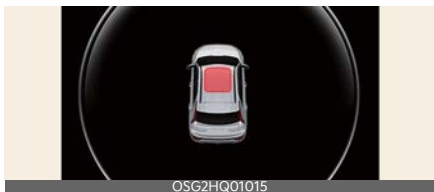

If the driver turns off the engine when the sunroof is not fully closed, the warning chime will sound for several seconds and the sunroof open warning will appear on the cluster LCD display.

Close the sunroof securely when leaving your vehicle.

⚠ CAUTION

Make sure the sunroof is closed fully when leaving your vehicle. If the sunroof is left open, rain or snow may wet the interior of the vehicle.

Also, leaving the sunroof open when the vehicle is unattended may invite theft.

Steering wheel

Motor Driven Power Steering (MDPS)

Power steering uses the motor to assist you in steering the vehicle.

If the engine is off or if the power steering system becomes inoperative, the vehicle may still be steered, but it will require increased steering effort.

The MDPS is controlled by the power steering control unit which senses the steering wheel torque and vehicle speed to command the motor.

The steering effort becomes heavier as the vehicle's speed increases and becomes lighter as the vehicle's speed decreases for better control of the steering wheel.

Should you notice any change in the effort required to steer during normal vehicle operation, have the system checked by a professional workshop. Kia recommends to visit an authorized Kia dealer/service partner.

Adjusting steering wheel angle and height



Operation

1. Pull the lock-release lever (1) down.
2. Adjust the steering wheel to the desired angle (2) and height (3)(if equipped).
3. Pull the lock-release lever up.

* INFORMATION

Be sure to adjust the steering wheel to the desired position before driving.

▲ WARNING

- Never adjust the angle and height of the steering wheel while driving. You may lose steering control and cause severe personal injury, death or accidents.
- After adjusting, push the steering wheel both up and down to be certain it is locked in position.
- While adjusting the steering wheel angle and height, please do not push or pull it hard since the fixture can be damaged.

▲ CAUTION

Do not press or pull the steering wheel hardy while adjusting. The steering wheel column may be damaged.

* NOTICE

- After adjustment, sometimes the lock-release lever may not lock the steering wheel.

It is not a malfunction. This occurs when two gears engage. In this case, adjust the steering wheel again and then lock the steering wheel.

- The following symptoms may occur during normal vehicle operation:

- The MDPS warning light does not appear.
- The steering effort is high immediately after turning the ignition switch or ENGINE START/STOP button on. This happens as the MDPS system performs the diagnostics. When the diagnostics is completed, the steering effort will return to its normal condition.
- A click noise may be heard from the MDPS relay after the ignition switch or ENGINE START/STOP button is turned to the ON or LOCK position.
- Motor noise may be heard when the vehicle is at a stop or at a low driving speed.
- When the abnormality is detected in the electric power steering system, a deadly accident prevention purposes, steering assist functions will be stopped. At this time, the instrument panel warning light turns on or blinks and the power to manipulate the steering will be off. Please check immediately after moving the vehicle to a safe zone.
- The steering effort increases if the steering wheel is rotated continuously when the vehicle is not in motion. However, after a few minutes, it will return to its normal conditions.
- If the Motor Driven Power Steering System does not operate normally, the warning light appear on the instrument cluster. The steering wheel may become difficult to control or operate abnormally. In this case, have the system inspected by a professional workshop. Kia recommends to visit an authorized Kia dealer/service partner.

- When you operate the steering wheel in low temperature, abnormal noise could occur. If temperature rises, the noise will disappear. This is a normal condition.
- When jump starting the vehicle after battery discharge, the steering wheel may not function properly. It is a temporary situation due to low battery voltage, and upon stable battery charging, the steering wheel will function normally again. Please move the steering wheel around to make sure the steering wheel is functioning properly before driving the vehicle.

Heated steering wheel (if equipped)



Operation

1. Press the button to turn the heated steering wheel ON or OFF.
2. The heated steering wheel reverts to the OFF position whenever the vehicle is restarted.

* INFORMATION

The heated steering wheel automatically controls the steering wheel temperature depending on the ambient temperature when the vehicle is running.

⚠ WARNING

If the steering wheel becomes too warm, turn the system off. The heated steering wheel may cause burns even at low temperatures, especially if used for long periods of time.

⚠ CAUTION

- Do not install any type of grip cover for the steering wheel, it may impair the function of the heated steering wheel system.
- When cleaning the heated steering wheel, do not use an organic solvent such as paint thinner, benzene, alcohol and gasoline. Doing so may damage the surface of the steering wheel.
- If the surface of the steering wheel is damaged by a sharp object, damage to the heated steering wheel components could occur.

* NOTICE

The heated steering wheel will turn off automatically approximately 30 minutes after the heated steering wheel is turned on.

Horn



OSG2H041074

Operation

- Press the area around the horn symbol on your steering wheel.

⚠ CAUTION

- Do not strike the horn severely to operate it, or hit it with your fist. Do not press on the horn with a sharp-pointed object.
- When cleaning the steering wheel, do not use an organic solvent such as thinner, benzene, alcohol and gasoline. Doing so may damage the steering wheel.

Mirrors

Inside rear view mirror

Adjusting the day/night rear view mirror (if equipped)

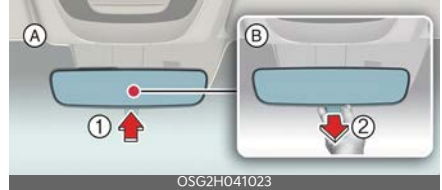

OSG2H041023

- A: Day
- B: Night

Operation

1. Push the day/night lever (1) during daytime.
2. Pull the day/night lever (2) to reduce the headlamp glare during low light and night driving conditions.

Electric Chromic Mirror (ECM) (if equipped)

The sensor detects the light level and automatically controls the headlamp glare during low light and night driving conditions.

⚠ WARNING

- Do not place objects in the rear seat or cargo area which would interfere with your vision out the rear window.
- Do not adjust the rear view mirror while the vehicle is moving. This could result in loss of control, and an accident which could cause DEATH, SERIOUS INJURY, or property damage.
- Do not modify the inside mirror and don't install a wide mirror. It could result in injury, during an accident or deployment of the air bag.

Outside rear view mirror

Adjusting the outside rear view mirror



Operation

1. Move the outside rear view mirror switch (1) to select the left or right side of the mirror.
2. Adjust the mirror adjustment control (2) to move the selected mirror.

⚠ WARNING

- The outside rear view mirror is convex. Objects seen in the mirror are closer than they appear.
- Use your interior rear view mirror or direct observation to determine the actual distance of following vehicles when changing lanes.
- Do not adjust or fold the outside rear view mirrors while the vehicle is moving. This could result in loss of control, and an accident which could cause DEATH, SERIOUS INJURY, or property damage.

⚠ CAUTION

- Do not scrape ice off the mirror face; this may damage the surface of the glass. If ice should restrict the movement of the mirror, do not force the mirror for adjustment. To remove ice, use a deicer spray, or a sponge or soft cloth with warm water.

- If the mirror is jammed with ice, do not adjust the mirror by force. Use an approved spray de-icer (not radiator antifreeze) to release the frozen mechanism or move the vehicle to a warm place and allow the ice to melt.
- The mirrors stop moving when they reach the maximum adjusting angles, but the motor continues to operate while the switch is pressed. Do not press the switch longer than necessary, the motor may be damaged.
- Do not attempt to adjust the outside rear view mirror by hand. Doing so may damage the parts.

Folding the outside rear view mirror

Manual type (if equipped)



Operation

- Grasp the housing of the mirror and fold it toward the rear of the vehicle.

Electric type (if equipped)



Operation

- Press the button to fold or unfold the mirror.

Auto reverse function (if equipped)



The outside rear view mirror will move downwards when the vehicle is in R (Reverse) position to assist reverse parking.

Operation

- The outside rear view mirror switch (1) position determines the mirror movement:
 - L/R: Outside rear view mirrors will move.
 - Center: Outside rear view mirrors will not move.

Auto Reverse function user setting

Operation

1. Shift to P (Park).
2. Move the switch to the L or R position depending on the mirror you want to adjust.
3. Shift to R (Reverse).
4. Adjust the mirror.

Initializing the Auto Reverse function

Operation

1. Shift to P (Park).
2. Move the switch to the L or R position depending on the mirror you want to adjust.
3. Shift to R (Reverse).
4. Adjust the mirror higher than the standard angle.
5. Shift to another gear position.

⚠ WARNING

- The outside rear view mirror is convex. Objects seen in the mirror are closer than they appear.
- Use your interior rear view mirror or direct observation to determine the actual distance of following vehicles when changing lanes.
- Do not adjust or fold the outside rear view mirrors while the vehicle is moving. This could result in loss of control, and an accident which could cause DEATH, SERIOUS INJURY, or property damage.

⚠ CAUTION

- Do not scrape ice off the mirror face; this may damage the surface of the glass. If ice should restrict the movement of the mirror, do not force the mirror for adjustment. To remove ice, use a deicer spray, or a sponge or soft cloth with warm water.
- If the mirror is jammed with ice, do not adjust the mirror by force. Use an approved spray de-icer (not cooling system antifreeze) to release the frozen mechanism or move the vehicle

to a warm place and allow the ice to melt.

- The mirrors stop moving when they reach the maximum adjusting angles, but the motor continues to operate while the switch is pressed. Do not press the switch longer than necessary, the motor may be damaged.
 - Do not attempt to adjust the outside rear view mirror by hand. Doing so may damage the parts.
 - The electric type outside rear view mirror operates even though the vehicle is in the OFF position. However, to prevent unnecessary battery discharge, do not adjust the mirrors longer than necessary while the vehicle is not running.
 - In case it is an electric type outside rear view mirror, don't fold it by hand. It could cause motor failure.
 - We recommend following the procedures in an orderly manner to change or initialize the auto reversing user settings. If you move to the next step before completing the previous one, the changed angle may not be changed or initialization may not work properly.
-

Instrument cluster

Type A

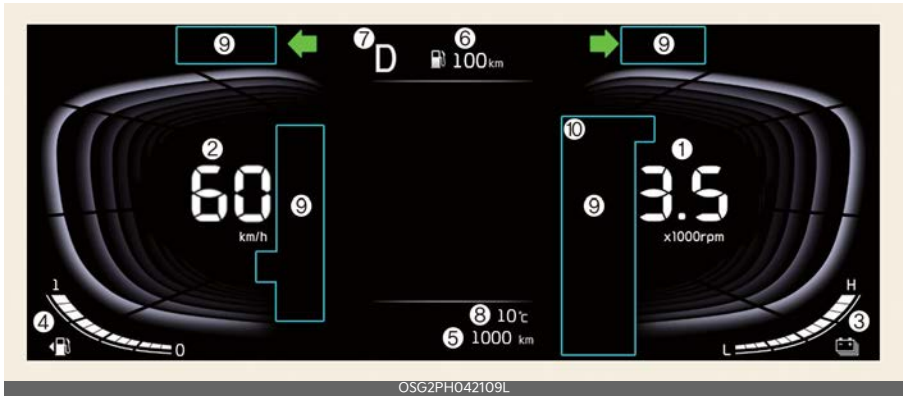

Type B



5

1. Tachometer/Power gauge

• Tachometer

Indicates the approximate number of engine revolutions per minute (rpm). For type B, select Settings → Vehicle → Cluster → Tachometer display to display tachometer based on drive mode.

• Power gauge

Indicates whether the current driving condition is fuel efficient or not.

- CHARGE: energy made by the vehicle is being converted to electrical energy. (Regenerated energy)
- ECO: Shows that the vehicle is being driven in an Eco-friendly manner.
- POWER: Shows that the vehicle is exceeding the Eco-friendly range.

2. Speedometer

- km/h, MPH
- The speed of the vehicle in kilometers per hour (km/h) or miles per hour (mph).

3. Hybrid battery SOC gauge

- Indicates the remaining hybrid battery power.

4. Fuel gauge

- Indicates the approximate amount of fuel remaining in the fuel tank.

5. Odometer

- Indicates the total distance that the vehicle has been driven.

6. Distance to empty

- Indicates the distance the vehicle can be driven with the remaining fuel.

7. Transmission shift indicator (if equipped)

- Indicates which gear is selected.

Dual clutch transmission shift indicator

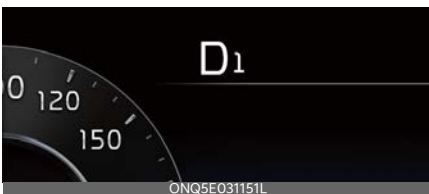

This indicator displays which shift lever is selected.

- Park: P
- Reverse: R
- Neutral: N

- Drive: D₁, D₂, D₃, D₄, D₅, D₆
- Manual mode: S₁, S₂, S₃, S₄, S₅, S₆

8. Outside temperature gauge

- Indicates the current outside air temperatures.

9. Warning and indicator lights

- Refer to "Warning and indicator lights" on page 5-67.

10. Plug-in hybrid mode indicator (Plug-in hybrid vehicle)

- CD (Charge Depleting, Electric) mode: The high-voltage (hybrid) battery is used to drive the vehicle.
- AUTO mode: The AUTO mode will be automatically selected from either from Electric (CD) mode or Hybrid (CS) mode by the system according to the driving
- CS (Charge Sustaining, Hybrid) mode: The high-voltage (hybrid) battery and gasoline engine is used to drive the vehicle. A corresponding message is displayed to indicate the selected mode.
- EV+ mode: The high-voltage (hybrid) battery is only used to drive the vehicle. (Except completely depressing the accelerator pedal)

Full LCD cluster (if equipped)

The full LCD type cluster provides two themes.

Link to Drive Mode

This is the basic theme of the full LCD type cluster and provides different graphic styles depending on drive mode.

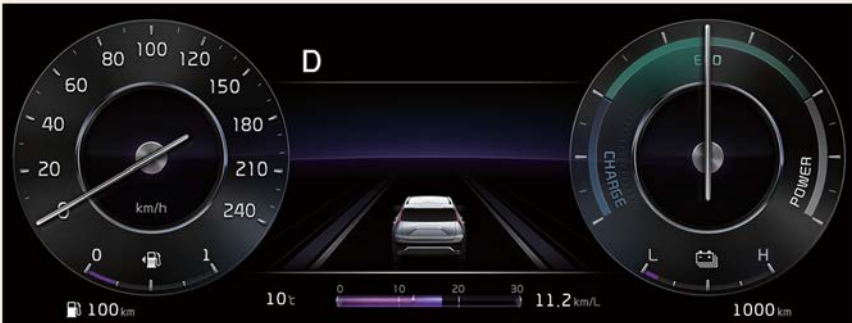

OSG2PH042119L

5

Theme

This is set by the user and provides digital display. The background screen changes according to the weather and time.

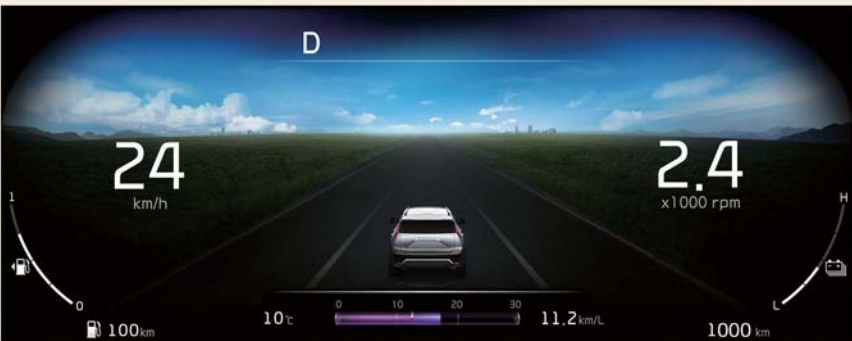

OSG2PH042120L

- Weather: sunny, cloudy, rainy, snowy, foggy, lightning (7 types)
- Time: night, day, sunrise and sunset (4 types)

You can change the theme by selecting "Vehicle → Cluster → Cluster theme" on the menu.

⚠ CAUTION

The information is displayed after getting information from a weather information provider via GPS. Depending on conditions of GPS reception, the information may be different from the current weather in your area.

If no information is received via GPS (e.g., not subscribed to Kia Connect service), the weather and time will be displayed as 'sunny' and 'night' on the cluster.

⚠ WARNING

- Never remove the engine coolant reservoir cap when the engine is hot. The engine coolant is under pressure and could severely burn. Wait until the engine is cool before adding coolant to the reservoir.
- Running out of fuel can expose vehicle occupants to danger. You must stop and obtain additional fuel as soon as possible after a low fuel warning light (🛢) appears or when the gauge indicator comes close to the "E (O) (Empty)" level.

⚠ CAUTION

- For full LCD type cluster (Type B), the information is displayed after getting information from a weather information provider via GPS. Depending on conditions of GPS reception, the information may be different from the current weather in your area. If no information is received via GPS (e.g., not subscribed to Kia Connect service), the weather and time will be displayed as 'sunny' and 'night' on the cluster.

- Be careful while driving as dynamic themed animation effects can distract the driver and lead to unexpected accidents.
- Do not operate the engine within the tachometer's red zone. This may cause severe engine damage.

*** NOTICE**

- According to the hybrid system gauge area, the "EV" indicator comes on or off.
 - "EV" indicator ON : Vehicle is driven using the electric motor or the gasoline engine is stopped.
 - "EV" indicator OFF : Vehicle is driven using the gasoline engine.
- Never try to start the vehicle if the fuel tank is empty. In this condition, the engine cannot charge the high voltage battery of the hybrid system. If you try to start the vehicle when the fuel is empty, the high voltage battery will become discharged and be damaged.
- The fuel tank capacity is given in "Recommended lubricants and capacities" on page 9-6.
- The fuel gauge is supplemented by a low fuel warning light (🛢), which will appear when the fuel tank is nearly empty.
- On inclines or curves, the fuel gauge pointer may fluctuate or the low fuel warning light may come on earlier than usual due to the movement of fuel in the tank.
- If the vehicle is not on level ground or the battery power has been interrupted, the distance to empty function may not operate correctly.

- The distance to empty may differ from the actual driving distance as it is an estimate of the available driving distance.
 - The trip computer may not register additional fuel if less than 6 liters (1.6 gallons) of fuel are added to the vehicle.
 - The fuel economy and distance to empty may vary significantly based on driving conditions, driving habits, and condition of the vehicle.
 - Use a clean soft microfiber cloth to gently wipe any finger prints off the screen.
-

Fuel economy

This information is always displayed at the bottom center of the Full LCD cluster.



- 1 Average fuel economy
- 2 Instant fuel economy

1. Average fuel economy

The average fuel economy is calculated by the total driving distance and fuel consumption since the last average fuel economy reset.

- **At vehicle start** : The information will automatically reset when the driver's door is opened after the vehicle is turned off, or approximately 3 minutes have passed after the vehicle is turned off.
- **After refueling** : After refueling more than 6 liters (1.5 gallons) and driving over 1 km/h (1 mph), the vehicle will reset to default automatically.
- **Manually** : Press and hold the OK button on the steering wheel when the average fuel economy is displayed.

2. Instant fuel economy

Displays the instant fuel economy during the last few seconds when the vehicle speed is more than approximately 10 km/h (6 mph).

* INFORMATION

This information is always displayed at the bottom center of the Full LCD cluster.

Driving Assist mode

This mode displays the state of:

- Forward Collision-Avoidance Assist
- Lane Keeping Assist
- Blind-Spot Collision-Avoidance Assist
- Smart Cruise Control
- Lane Following Assist
- Highway Driving Assist

Trip computer mode

* You may change through items in the following order.

Drive info

Type A



Type B

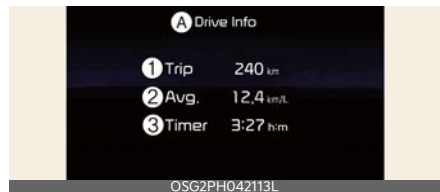

A: Drive info

- 1 Accumulated trip distance
- 2 Average fuel efficiency
- 3 Total driving time

The information after one ignition cycle.

Drive Info screen will reset when the driver's door is opened after turning off the vehicle, or the vehicle is turned on after 3 minutes have passed.

Since refuelling

Type A



Type B



A: Since refuelling

- 1 Accumulated trip distance
- 2 Average fuel efficiency
- 3 Total driving time

The information after refueling.

To manually reset the information, press and hold the OK button on the steering wheel when viewing the **Since refuelling**.

Accumulated info

Type A



Type B



A: Accumulated info

- 1 Accumulated trip distance
- 2 Average fuel efficiency
- 3 Total driving time

The information is accumulated starting from the last reset.

To manually reset the information, press and hold the OK button on the steering wheel when viewing the **Accumulated Info**.

* NOTICE

- The average fuel economy is not displayed for more accurate calculation if the vehicle does not drive more than 10 seconds or approximately 50 m (0.03 miles) since the vehicle is in ON position.
- Fuel efficiency is calculated after the vehicle has run for more than 300 meters.
- The information will be accumulated even if the engine is running and the vehicle is not in motion.

Digital speedometer

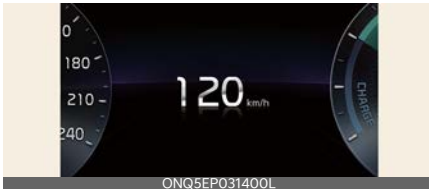

Indicates the speed of the vehicle.

Range (Plug-in hybrid vehicle)

The range is the estimated distance the vehicle can be driven with the remaining high-voltage (hybrid) battery (1, Electric) and fuel in the fuel tank (2, Gasoline).

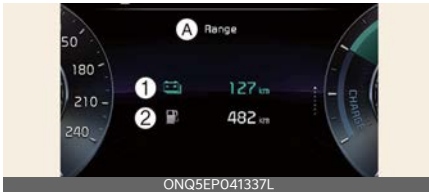

A: Range

- 1 Estimated distance with the remaining high-voltage (hybrid) battery (Electric)
 - 2 Estimated distance with the fuel in the fuel tank (Gasoline)
- If the estimated distance is below 1 km (1 mile), the trip computer will display "—" as distance to empty.
 - Distance range: 1 ~ 510 km or 1 ~ 510 miles.

* NOTICE

- If the vehicle is not on level ground or the battery power has been interrupted, the range function may not operate correctly.
- The range may differ from the actual driving distance as it is an estimate of the available driving distance.
- The trip computer may not register additional fuel if less than 6 liters (1.6

gallons) of fuel are added to the vehicle.

- The range may vary significantly based on driving conditions, driving habits, and condition of the vehicle.

Energy flow



A: Hybrid Mode

The hybrid system informs the driver about its energy flow in various operating modes. While driving, the current energy flow is specified in 11 modes.

* For more details, refer to "Energy flow" on page 1-26.

Turn By Turn (TBT) mode

This mode displays the Navigation status.

Information mode

Tire pressure



A: Low tyre pressure

Information related to tire pressure. Refer to "Tire Pressure Monitoring System (TPMS) (if equipped)" on page 7-9.

Engine Temperature



Indicates the temperature of the engine coolant when the engine is running.

Master warning mode

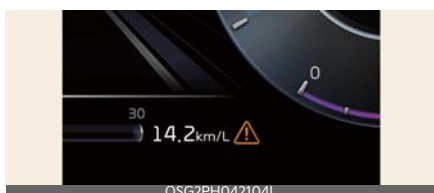

This mode informs you of the following situations:

- Driver assistance system malfunction, limitation or radar/camera blockage
- LED headlamp malfunction
- Lamp malfunction
- TPMS failure, low tire pressure, etc.

At this time, the Master warning light () will appear. If the warning situation is solved, the master warning light will be turned off and the Master Warning icon will disappear.

Service Interval

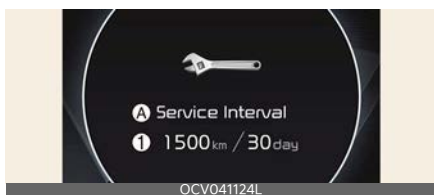

A: Service Interval

- 1 Service interval schedule

It calculates and displays when you need a scheduled maintenance service (mileage or days).

To reset the service interval, select **Convenience** → **Service Interval** → **Reset** from the Settings menu.

* NOTICE

- If the remaining mileage or time reaches 1,500 km (900 miles) or 30 days, the message **Service in** is displayed for several seconds each time you set the vehicle to the ON position.
- If you do not have your vehicle serviced according to the already inputted service interval, **Service required** message is displayed for several seconds each time you set the vehicle to the ON position.
- If any of the following conditions occurs, the mileage and days may be incorrect.
 - The battery cable is disconnected.
 - The battery is discharged.

User settings mode

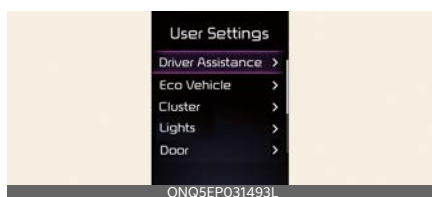

In this mode, you can change the settings of the instrument cluster, doors, lights, etc.

* The information provided may differ depending on which functions are applicable to your vehicle.

1. Driver Assistance (if equipped)

Items	Explanation
Driving Convenience	<ul style="list-style-type: none"> • Smart Cruise Control • Highway Driving Assist • Auto Highway Speed Control
Speed Limit	<ul style="list-style-type: none"> • Speed Limit Offset • Speed Limit Assist/Speed Assist Warning/Off
Warning Volume	<ul style="list-style-type: none"> • High/Medium/Low/Off
Haptic Warning	Activate/Deactivate
Driver Attention Warning	<ul style="list-style-type: none"> • Leading vehicle departure alert • Inattentive driving warning
Driving Safety	<ul style="list-style-type: none"> • Forward Safety • Forward Safety Warning Timing - Normal/Late • Lane Safety • Blind-Spot Safety • Exit Safety
Parking Safety	<ul style="list-style-type: none"> • Parking Distance Warning Auto On • Rear Cross-Traffic Safety

Items	Explanation
Content Selection	<ul style="list-style-type: none"> • Turn by Turn • Traffic Signs • Driving Convenience Info • Blind-Spot Safety Info • Radio/Media Info

4. Cluster (if equipped)

Items	Explanation
Theme Selection	<ul style="list-style-type: none"> • Link to Drive Mode • Theme A/Theme B/Theme C
Wiper/Lights Display	Activate/Deactivate
Traffic Signs	Activate/Deactivate
Icy Road Warning	Activate/Deactivate
Cluster Voice Guidance Volume	<ul style="list-style-type: none"> • 0~3 Level
Welcome Sound	Activate/Deactivate

5. Lights (if equipped)

Items	Explanation
Illumination	<ul style="list-style-type: none"> • 1~20 Level
One Touch Turn Signal	<ul style="list-style-type: none"> • Off/3/5/7 Flashes
Ambient Brightness	<ul style="list-style-type: none"> • Off/1/2/3/4
Ambient Light Color	<ul style="list-style-type: none"> • 8 colors
Headlight Delay	Activate/Deactivate
High Beam Assist	Activate/Deactivate

2. Eco Vehicle (if equipped)

Items	Explanation
Green Zone EV Drive	Activate/Deactivate
Coasting Guide	<ul style="list-style-type: none"> • Enable Coasting Guide • Sound On/Sound Off
Start Coasting	<ul style="list-style-type: none"> • Early/Normal/Late
Smart Regeneration	Activate/Deactivate
Charging Connector Locking Mode (for PHEV)	<ul style="list-style-type: none"> • Always lock/While charging/Do not lock
Charge Guidance Sound (for PHEV)	<ul style="list-style-type: none"> • High/Medium/Low/Off

3. Head-Up Display (if equipped)

Items	Explanation
Enable Head-Up Display	Activate/Deactivate
Display Height	<ul style="list-style-type: none"> • 1~20 Level
Rotation	<ul style="list-style-type: none"> • -5 ~ +5
Brightness	<ul style="list-style-type: none"> • 1~20 Level

6. Door (if equipped)

Items	Explanation
Automatically Lock	<ul style="list-style-type: none"> • Enable on shift/Enable on speed/Off
Automatically Unlock	<ul style="list-style-type: none"> • On shift to P/Vehicle Off/On key out (if equipped)/Off
Power Tailgate	Activate/Deactivate
Power Tailgate Opening Speed	<ul style="list-style-type: none"> • Fast/Normal
Power Tailgate Opening Height	<ul style="list-style-type: none"> • Full open/Level 3/Level 2/Level 1/User Height Setting
Smart Tailgate	Activate/Deactivate
Remote Window Control (if equipped)	Activate/Deactivate

* INFORMATION

• Automatically Lock

- **Enable On Shift** : All doors will be automatically unlocked when the vehicle is shifted to P (Park) to R (Reverse), N (Neutral), or D (Drive). (With the Engine ON, it is activated.)
- **Enable On Speed** : All doors will be automatically locked when the vehicle speed is over 15 km/h (9 mph).

• Automatically Unlock

- **On Shift to P** : All doors will be automatically unlocked if the gear is shifted to the P (Park) position. (With the Engine ON, it is activated.)
- **Vehicle Off/On key out (if equipped)** : All doors will be automatically unlocked when the ignition key is removed from the ignition switch or the ENGINE START/STOP button is set to the OFF position.

7. Convenience (if equipped)

Items	Explanation
Seat Easy Access	• Off/Normal/Extended
Rear Occupant Alert	Activate/Deactivate
Service Interval	• Enable Service Interval/ Adjust Interval/Reset
Welcome Mirror/Light	• On door unlock/On door unlock
Wireless Charging System	Activate/Deactivate
Auto rear wiper (in R)	Activate/Deactivate
PASSENGER AIR BAG	Activate/Deactivate

8. Units

Items	Explanation
Speed Unit	• km/h, MPH
Temperature Unit	• °C, °F
Fuel Economy Unit	• km/L, L/100km
Tire Pressure Unit	• psi/kPa/bar

9. Language

Items	Explanation
Language	Activate

10. Reset

Items	Explanation
Reset	• Yes/No

Driver Assistance settings (infotainment system) (if equipped)









select **Settings** → **Vehicle** → **Driver Assistance** on the infotainment system screen to set the Driver Assistance function.

- **Driver Assistance**
 - **Driving Convenience**
 - **Speed Limit**
 - **Driving Safety**
 - **Warning Volume**
 - **Haptic Warning**
 - **Driver Attention Warning**
 - **Parking Safety**

* INFORMATION

The infotainment system may change after software updates. For more information, refer to the manual provided in the infotainment system and the quick reference guide.

LCD display messages

LCD displays	Displayed contents
 <p>OSG2PH042106L</p>	<p>Door, hood, tailgate, sunroof open</p>
 <p>OSG2PH042110L</p>	<p>Low tyre pressure warning display A: Low tyre pressure</p>
 <p>ONQ5041286L</p>	<ul style="list-style-type: none"> • A: Lights • 1:  • 2:  • 3: AUTO • 4: OFF (O)
 <p>ONQ5041287L</p>	<ul style="list-style-type: none"> • A: Front Wiper • 1: OFF (O) • 2: AUTO • 3: LO (1) • 4: HI (2)
<p>Low washer fluid</p>	<p>The washer fluid level in the reservoir is nearly empty.</p>
<p>Engine overheated</p>	<p>The engine coolant temperature is above 120 °C (248 °F).</p>
<p>Low key battery (for smart key system)</p>	<p>The battery of the smart key is discharged</p>
<p>Key not in vehicle (for smart key system)</p>	<p>The smart key is not in the vehicle when you press the ENGINE START/STOP button</p>
<p>Icy road warning</p>	<p>The temperature on the outside temperature gauge is below approximately 4 °C (40 °F).</p>
<p>Key not detected (for smart key system)</p>	<p>The smart key is not detected when you press the ENGINE START/STOP button</p>
<p>Shift to P or N to start engine (for smart key system)</p>	<p>Starting the vehicle with the gear not in the P (Park) or N (Neutral) position</p>
<p>Press brake pedal to start vehicle (for smart key system)</p>	<p>The ENGINE START/STOP button changes to the ACC position twice by pressing the button repeatedly without depressing the brake pedal</p>

LCD displays	Displayed contents
Battery discharging due to external electrical devices	Self-discharge of the battery due to overcurrent that is generated by unauthorized electrical devices
Press START button again (for smart key system)	The ENGINE START/STOP button cannot be operated due to a problem with the ENGINE START/STOP button system
Press START button with key (for smart key system)	The ENGINE START/STOP button is pressed while the "Key not detected" warning message is displayed
Low fuel	The fuel tank is almost out of fuel. The low fuel level warning light in the cluster will come on
 <p>A: Coast</p>	<p>A chime will sound and the coasting guide indicator will be displayed to inform the driver when to take the foot off the accelerator by anticipating a decelerating event* based on the analysis of driving routes and road conditions stored in the navigation system. It encourages the driver to remove the foot from the pedal and allow coasting down the road with EV motor only. This helps preventing unnecessary fuel consumption and increases fuel efficiency.</p> <p>* Example of a deceleration event is going down an extended hill, slowing down approaching a toll booth, and approaching reduced speed zones.</p> <ul style="list-style-type: none"> User settings Press the ENGINE START/STOP button and put the shift dial in P (Park). In the User Settings Mode, select Driver assistance, Coasting Guide, and then On to turn on the system. Cancel the selection of coasting guide to turn off the system. For the explanation of the system, press and hold the [OK] button. Operation conditions To activate the system, take the following procedures. Enter your destination information on the navigation and select the driving route. Select the ECO mode in the Integrated Driving Control System. Then, satisfy the following: <ul style="list-style-type: none"> The driving speed should be between 30 km/h (19 mph) and 160 km/h (99 mph). <p>* The operating speed may vary due to difference between instrument cluster and navigation effected by tire inflation level.</p>

For Plug-in hybrid vehicle

LCD displays	Displayed contents
Unplug vehicle to start	The engine is started without unplugging the charging cable
Remaining Time	The remaining time to fully charge the battery is notified
Shift to P to charge	The charging connector is plugged with the shift dial in R (Reverse), N (Neutral) or D (Drive)
Electric mode/Automatic mode/Hybrid mode	A corresponding message is displayed when a mode is selected by pressing the EV button
Low battery. Maintaining Hybrid mode	Unable to convert to EV mode even when pressing the EV button during HEV mode driving due to insufficient high-voltage (hybrid) battery level
Low system temperature. Switching to Hybrid mode/ High system temperature. Switching to Hybrid mode	The temperature of the high-voltage (hybrid) battery is too low or high
Low system temperature. Maintaining Hybrid mode/ High system temperature. Maintaining Hybrid mode	The temperature of the high-voltage (hybrid) battery is too low or too high

LCD displays	Displayed contents
Wait until fuel door opens	Attempting to open the fuel filler door with the fuel tank pressurized
Fuel door open	The fuel filler door opens after the fuel tank is depressurized
Charging stopped. Check the AC charger	The charging failed by external charger error
Charging stopped. Check the cable connection	Charging is stopped because the charging connector is not correctly connected to the charging inlet
Charging Door Open	The charging door is open while in driving- ready state to encourage you to inspect and close the door
Switching to Hybrid mode to allow heating or air conditioning	<ul style="list-style-type: none"> Turning the climate control On for heating when the outdoor temperature is lower than -15 °C (5 °F) and the coolant temperature is lower than 70 °C (158 °F). The vehicle will automatically switch to HEV mode and EV mode will not be activated (although EV button is pressed) The outdoor temperature is higher than -10 °C (14 °F), or the coolant temperature is higher than 80 °C (176 °F) or you turn the climate control Off, the vehicle will automatically return to EV mode.
Switching to Hybrid mode for self-diagnosis	This message is displayed for self-diagnosis of the hybrid mode system

*** INFORMATION**

- If there is no problem with the operation and the messages above are constantly displayed, have your vehicle inspected by a professional workshop. Kia recommends to contact an authorized Kia dealer/service partner.
- **Icy road warning**
When the following conditions occur, the warning light (including outside temperature gauge) blinks 5 times and then appears, and also warning chime sounds once.
 - The temperature on the Outside Temperature Gauge is below approximately 4°C (40°F).
- **Battery discharging due to external electrical devices**
The vehicle can detect self-discharge of the battery due to overcurrent that is generated by unauthorized electrical devices such as dashboard camera (dash cam) mounting during parking.
If the warning continues even after external electrical devices are

removed, have your vehicle inspected by a professional workshop. Kia recommends to contact an authorized Kia dealer/service partner.

- **Press START button again**
 - You could start the engine by pressing the ENGINE START/STOP button once more.
 - If the warning message is displayed each time you press the ENGINE START/STOP button, have the vehicle inspected by a professional workshop. Kia recommends to visit an authorized Kia dealer/service partner.

⚠ CAUTION

- Low fuel
 - Driving with the low fuel level warning light on or with the fuel level below "E (O) (Empty)" can cause the engine to misfire and damage the catalytic converter.

* NOTICE

- If the warning message is displayed in the cluster, the driving information message may not be displayed.
- To set the charging time and/or climate time, refer to a separately supplied car navigation system manual for detailed information.
- If the icy road warning appears while driving, you should drive more attentively and safely refraining from over-speeding, rapid acceleration, sudden braking or sharp turning, etc.

Vehicle settings (infotainment system) (if equipped)



1. Press the **Settings** button on the head unit of the infotainment system.
2. Select **Vehicle** and change the setting of the features.

Vehicle Settings in the infotainment system provides user options for a variety of settings including door lock/unlock features, convenience features, driver assistance settings, etc.

- **Vehicle Settings**
 - **Driver Assistance**
 - **Eco Vehicle**
 - **Head-Up Display**
 - **Cluster**
 - **Climate**
 - **Seat**
 - **Lights**
 - **Door**
 - **Convenience**

⚠ WARNING

Do not operate the **Vehicle Settings** while driving. This may cause distraction resulting in an accident.

* NOTICE

















The information provided may differ depending on which features are applicable to your vehicle.

*** INFORMATION**

The infotainment system may change after software updates. For more information, refer to the manual provided in the infotainment system and the quick reference guide.

Warning and indicator lights

Once you set the vehicle to the ON position, the symbols shown below will light up. If these symbols remain on or malfunction, we recommend having the vehicle inspected by an authorized Kia dealer/service partner.

Symbol	Time	Notes
	6 seconds	The air bag warning light appears for about 6 seconds and then turns off.
	Continuously	<ul style="list-style-type: none"> There is a malfunction with the Safety Restraint System (SRS) air bag operation.
	Continuously	Seat belt warning light informs the driver that the seat belt is not fastened. Refer to "Seat belts" on page 4-12.
	3 seconds	Parking brake & brake fluid warning light appears for approximately 3 seconds.
	Continuously	<ul style="list-style-type: none"> Red: When the parking brake is applied. Red: When the brake fluid level in the reservoir is low. Red: When the regenerative brake does not operate. Yellow: Regenerative brake warning light appears when the regenerative brake does not operate and the brake does not perform well.
	3 seconds	The Anti-lock brake system (ABS) warning light appears for about 3 seconds and then goes off.
	Continuously	<ul style="list-style-type: none"> Whenever there is a malfunction with the ABS.
 	Continuously	Electronic Brake Force Distribution (EBD) system warning light appears when there is a problem with the Electronic Brake Force Distribution system.
	3 seconds	Motor Driven Power Steering (MDPS) warning light appears for about 3 seconds and then goes off.
	Continuously	<ul style="list-style-type: none"> Whenever there is a malfunction with the electric power steering.
	3 seconds	Charging system warning light appears for approximately 3 seconds and then goes off.
	Continuously	<ul style="list-style-type: none"> Whenever there is a malfunction with either the alternator or electrical charging system.
	Continuously	Master warning light appears when there is a malfunction in various vehicle functions. To identify the details of the warning, refer to the LCD display warning message.
	3 seconds	Malfunction Indicator Lamp (MIL) appears for approximately 3 seconds and then goes off.
	Continuously	<ul style="list-style-type: none"> Whenever there is a malfunction with either the emission control system or the engine or the vehicle powertrain.
	Continuously	Engine oil pressure warning light appears until the engine is started. <ul style="list-style-type: none"> When the engine oil pressure is low.
	3 seconds	Service warning light appears for approximately 3 seconds and then goes off.
	Continuously	<ul style="list-style-type: none"> Whenever there is a malfunction with hybrid vehicle control system or hardware.
	Continuously	<ul style="list-style-type: none"> When the fuel tank is nearly empty.
	Continuously	<ul style="list-style-type: none"> When there is a malfunction with Gasoline Particulate Filter (GPF) system.
EPB	3 seconds	Electronic Parking Brake EPB warning light appears for about 3 seconds and then goes off.
	Continuously	<ul style="list-style-type: none"> Whenever there is a malfunction with the Electronic Parking Brake EPB
	3 seconds	Low tire pressure warning light appears for approximately 3 seconds and then goes off.
	Continuously	<ul style="list-style-type: none"> When one or more of your tires are significantly under inflated.
	Blinking	<ul style="list-style-type: none"> When there is a malfunction with the TPMS. Refer to "Tire Pressure Monitoring System (TPMS) (if equipped)" on page 7-9.
	3 seconds	Forward Safety warning light appears for approximately 3 seconds and then goes off.
	Continuously	<ul style="list-style-type: none"> Whenever there is a malfunction with Forward Collision-Avoidance Assist. Refer to "Forward Collision-Avoidance Assist (FCA) (Front Camera Only) (if equipped)" on page 6-44.

Symbol	Time	Notes
	Continuously	Lane safety indicator light appears: <ul style="list-style-type: none"> Green: When Lane Keeping Assist operating conditions are satisfied. Gray: When Lane Keeping Assist operating conditions are not satisfied. Yellow: Whenever there is a malfunction with Lane Keeping Assist. Refer to "Lane Keeping Assist (LKA) (if equipped)" on page 6-65.
	Continuously	Lane Following Assist indicator light appears: <ul style="list-style-type: none"> Green: When Lane Following Assist is activated Gray: When Lane Following Assist operating conditions are not satisfied. Refer to "Lane Following Assist (LFA) (if equipped)" on page 6-120.
	3 seconds	LED headlight warning light appears for approximately 3 seconds and then goes off.
	Continuously	Whenever there is a malfunction with the LED headlight.
	Blinking	Whenever there is a malfunction with a LED headlight related part.
	Continuously	Icy Road warning light and outside temperature gauge blinks and then appears. Also, the warning chime sounds 1 time.
	Continuously	Charging cable connection indicator (Plug-in hybrid vehicle) light appears in red when the charging cable is connected.
EV	Continuously	EV mode indicator appears when the vehicle is driven using the electric motor or the gasoline engine is stopped.
READY	Continuously	Ready indicator appears when the vehicle is ready to be driven.
	Blinking	Whenever there is a problem with the system.
	3 seconds	Electronic Stability Control (ESC) indicator light appears for about 3 seconds and then goes off.
	Continuously	Whenever there is a malfunction with ESC system.
	Blinking	While the ESC is operating.
	3 seconds	The ESC OFF indicator light appears for approximately 3 seconds and then goes off.
	Continuously	When you deactivate ESC system by pressing the ESC OFF button. Refer to "Electronic Stability Control (ESC)" on page 6-37.
	Continuously	When the vehicle detects the key in the vehicle in ACC/ON position
	Blinking	When the key is not in the vehicle Whenever there is a malfunction with the immobilizer system.
	2 seconds	When the vehicle cannot detect the key.
	Blinks	When the turn signal light is on.
	Continuously	When high-beam headlamps are on.
	Continuously	When low-beam headlamps are on.
	Continuously	When the light switch is in the ON position.
	Continuously	When the front fog lights are on.
	Continuously	When the rear fog lights are on.
	Continuously	When High Beam Assist (HBA) is activated. Refer to "High Beam Assist (HBA) (if equipped)" on page 5-75.
AUTO HOLD	Continuously	When AUTO HOLD is activated.
SOS	3 seconds	SOS warning light appears for approximately 3 seconds and then goes off.
	Continuously	Whenever there is a malfunction with the eCall system. Refer to "Pan-European eCall system (if equipped)" on page 7-28.

Symbol	Time	Notes
ECO SPORT	Continuously	Drive mode indicator light appears when you select each mode as drive mode. Refer to "Drive mode integrated control system" on page 6-41.
120 km/h	Blinking	Overspeed warning light blinks when you drive the vehicle more than 120 km/h. The overspeed warning chime also sound for approximately 5 seconds.
	Continuously	Green zone drive mode indicator light appears when you entering the inner road under as entering the inner road of a large hospital or school, registered favorites (Home/Office) and (Ultra) Low emission zone (For Europe/Plug-in hybrid vehicle only). Refer to "Green Zone Drive Mode for Europe" on page 6-43.

*** INFORMATION**

• **Dual-diagonal braking system**

Your vehicle is equipped with dual diagonal braking systems. This means you still have braking on two wheels even if one of the dual systems should fail.

With only one of the dual systems working, more than normal pedal travel and greater pedal pressure are required to stop the vehicle. Also, the vehicle will not stop in as short a distance with only a portion of the brake system working.

• **Engine oil pressure warning light  - When the engine oil pressure is low**

- Drive carefully to the nearest safe location and stop your vehicle.
- Turn the engine off and check the engine oil level (For more details, refer to "Engine oil" on page 8-22). If the level is low, add oil as required.
- If the engine oil pressure warning light () remains on after adding oil or if oil is not available, have the vehicle inspected by a professional workshop as soon as possible. Kia recommends to visit an authorized Kia dealer/service partner. Continued driving with the warning light on may cause engine failure.

• **Exhaust system (GPF) warning light**



- Exhaust system (GPF) warning light () may turn off after the vehicle speed is over approximately 80 km/h (50 mph), or above 3rd gear with 1,500~4,000 rpm for a certain time (approximately 30 minutes).
- If this warning light blinks in spite of the procedure (at this time the LCD warning message will be displayed), have the system checked by a professional workshop. Kia recommends to visit an authorized Kia dealer/service partner.

⚠ WARNING

• **Parking brake & brake fluid warning light **

- Driving the vehicle with a warning light ON is dangerous. If the parking brake & brake fluid warning light appears with the parking brake released, it indicates that the brake fluid level is low.
- In this case, have the vehicle inspected by a professional workshop. Kia recommends visiting an authorized Kia dealer/service partner.

• **Electronic Brake force Distribution (EBD) system warning light** 

- When both ABS and parking brake & brake fluid warning lights are on, the brake system will not work normally and you may experience an unexpected and dangerous situation during sudden braking.
- In this case, avoid high speed driving and abrupt braking. We recommend you have the vehicle inspected by an authorized Kia dealer/service partner as soon as possible.

• **Safe stopping**

- The TPMS cannot alert you to severe and sudden tire damage caused by external factors.
- If you notice any vehicle instability, immediately take your foot off the accelerator pedal, apply the brakes gradually with light force, and slowly move to a safe position off the road.

CAUTION

• **Low fuel level warning light** 

- Driving with the Low fuel level warning light on or with the fuel level below "E (O) (Empty)" can cause the engine to misfire.

• **Malfunction Indicator Lamp (MIL)**

-  If the Malfunction Indicator Lamp (MIL) appears, potential catalytic converter damage is possible which could result in loss of engine power. In this case, have the vehicle inspected by a professional workshop. Kia recommends to visit an authorized Kia dealer/service partner.

• **Exhaust system warning light** 

- If you continue to drive with the exhaust system warning light  blinking for a long time, the system can be damaged and fuel consumption can worsen.

*** NOTICE**

- Make sure that all warning lights are OFF after starting the vehicle. If any light is still ON, this indicates a situation that needs attention.

• **Malfunction Indicator Lamp (MIL)**

-  Driving with the Malfunction Indicator Lamp (MIL) on may cause damage to the emission control system which could affect drivability and/or fuel economy.
- If the enhanced engine protection system becomes activated due to lack of engine oil, engine power will be limited. If such condition continues repeatedly, the Malfunction Indicator Lamp (MIL) will appear.

• **Electronic Brake force Distribution (EBD) system warning light** 

- When the ABS warning light is on or both ABS and Parking Brake & Brake Fluid warning lights are on, the speedometer, odometer, or trip-meter may not work. Also, the MDPS warning light may appear and the steering effort may increase or decrease.
- In this case, avoid high speed driving and abrupt braking. We recommend you have the vehicle inspected by an authorized Kia dealer/service partner as soon as possible.

- **Electronic Parking Brake warning light EPB**

- The Electronic Parking Brake warning light (**EPB**) may appear when the Electronic Stability Control (ESC) indicator light comes on to indicate that the ESC is not working properly (This does not indicate malfunction of the EPB).

- Continuous driving with the LED Headlight warning light on or blinking can reduce LED headlight life.
- If the icy road warning light appears while driving, you should drive more attentively and safely refraining from over-speeding, rapid acceleration, sudden braking or sharp turning, etc.

- **Engine oil pressure warning light**



- When engine oil pressure decreases due to insufficient engine oil, etc., the engine oil pressure warning light (🛢️) will appear.
- The enhanced engine protection system which limits engine power will be activated. If the engine oil pressure is restored, the engine oil pressure warning light and the enhanced engine protection system will turn off.

Head-Up Display (HUD) (if equipped)

The Head-Up Display is a transparent display that projects an image of certain information from the instrument cluster and navigation system on the windshield glass.



- The head up display image on the HUD screen may be invisible when:
 - Sitting posture is bad.
 - Wearing a polarized sunglasses.
 - There is an object on the cover of the head up display.
 - Driving on a wet road.
 - An inadequate lighting is turned on inside the vehicle.
 - Any light comes from the outside.
 - Wearing an inadequate glasses to your eyesight.
- If the head up display image is not shown well, adjust the height, rotation or illumination of the head up display in the LCD display.
- When the head up display needs inspection or repair, Kia recommends to visit an authorized Kia dealer/service partner.

⚠ WARNING

Head-Up Display

- Do not make the front windshield glass have window tint or other types of metallic coating. Otherwise, the Head-Up Display image may be invisible.
- Do not place any accessories on the crash pad or attach any objects on the windshield glass.
- As Blind-Spot Collision Warning is a supplemental device for your safe driving, it may be dangerous to rely on only the BCW information of the Head-Up Display image when changing the lane. Always pay attention to drive safely.

- 5 SCC vehicle distance information (if equipped)
- 6 Lane Following Assist information (if equipped)
- 7 Lane Safety information (if equipped)
- 8 Blind-Spot Safety information (if equipped)
- 9 Highway Driving Assist information (if equipped)
- 10 Highway Auto Speed Change information (if equipped)
- 11 Surrounding vehicle information

*** NOTICE**

Road Signs and Turn By Turn navigation information are available depending on the region.

⚠ CAUTION

When replacing the front windshield glass of the vehicles equipped with the Head-Up Display, replace it with a windshield glass designed for the Head-Up Display operation. Otherwise, duplicated images may be displayed on the windshield glass.

Head-Up Display Setting

On the LCD display, you can change the head up display settings as follows.

Type A	Type B
Enable Head-Up Display	Enable HUD
Display Height	Display Control •Height •Rotation •Brightness
Rotation	
Brightness	
Content Selection	Content Selection

Head Up Display Information



- 1 Turn By Turn navigation information (if equipped)
- 2 Road signs
- 3 Speedometer
- 4 SCC set speed information (if equipped)

* For more details, refer to "User settings mode" on page 5-58.

Lighting

Lighting functions

Battery saver function

The purpose of this feature is to prevent the battery from being discharged.

The system automatically shuts off the parking lights after the engine is off and the driver's door is opened.

However, the position lamps stay ON even when the driver-side door is opened if the light switch is operated after the engine is turned off.

If necessary, to keep the lamps on turn the position lamps OFF and ON again using the headlamp switch on the steering column after the engine is turned off.

⚠ CAUTION

To prevent the battery from being discharged, do not leave the headlight and interior light on for a prolonged time while the engine is not running.

Headlamp escort function

Operation

- The headlamps remain on for approximately 5 minutes.
- If the driver's door is opened and closed, the headlamps turn off after 15 seconds.
- To turn the headlamps OFF:
 - Press the lock button on the key 2 times
 - Turn the headlamp switch to OFF position

Operating condition(s)

- The vehicle is in ACC or OFF position with the headlamps ON

Daytime Running Light (DRL)

Operating condition(s)

- The vehicle is in ON position
- The headlamp switch is in OFF position
- Parking brake is disengaged

* INFORMATION

If necessary, to keep the position lamp on when the vehicle is turned off, perform the following:

- Open the driver's side door.
- Turn the position lamp ON.

Lighting controls

Operating lights

Type A



Type B



Type C



Operation

1 OFF / 

2 AUTO

- Tailamps and headlamps will turn ON or OFF automatically depending on the amount of light outside the vehicle.

3 Position & Taillamp 

4 Low beam 

* INFORMATION

The vehicle must be in the ON position to turn on the headlights.

⚠ CAUTION

- Never place anything over the sensor located on the instrument panel as this will ensure better auto-light system control.
- Don't clean the sensor using a window cleaner, the cleaner may leave a light film which could interfere with sensor operation.
- If your vehicle has window tint or other types of metallic coating on the front windshield, the Auto light system may not work properly.

Operating turn signals

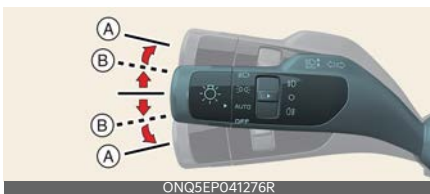

Operation

- Move the lever up or down (A).

* NOTICE

If an indicator flash is abnormally quick or slow, a bulb may be burned out or have a poor electrical connection in the circuit.

One-touch lane change function

Operation

1. Move the turn signal lever up or down (B).
2. Release the lever.



* INFORMATION

- You can activate or deactivate the One Touch Turn Signal function or choose the number of blinking (3, 5, or 7) by selecting "Lights → One Touch Turn signal" from the Settings menu.
- If an indicator stays on and does not flash or if it flashes abnormally, one of the turn signal bulbs may be burned out and will require replacement.

Operating fog lights (if equipped)



Operation

- Turn the front fog light switch (1) to the dedicated position.
- Front: /Rear: 

Operating condition(s)

- The headlamp is turned ON.

⚠ CAUTION

When in operation, the fog lights consume large amounts of vehicle electrical power. Only use the fog lights when visibility is poor.

Operating high beam**Operation**

- Push the lever to use high beam.
- Pull the lever towards you to flash the headlights (⊞D).

⚠ WARNING

Do not use high beam when there are other vehicles. Using high beam could obstruct the other driver's vision.

*** INFORMATION**

- If you push the lever away from you, the lever will return to its original position.
The high beam indicator will light when the headlight high beams are switched on.
- It will return to the normal (low beam) position when released after pulling the lever towards you. The headlight switch does not need to be on to use this flashing feature.

High Beam Assist (HBA) (if equipped)

High Beam Assist is a function that automatically adjusts the headlamp range (switches between high beam and low beam) depending on the brightness of detected vehicles and certain road conditions.

Detecting sensor

Front view camera



The front view camera is used as a detecting sensor to detect ambient light and brightness while driving. Refer to the picture above for the detailed location of the detecting sensor.

⚠ CAUTION

Always keep the front view camera in good condition to maintain optimal performance of High Beam Assist.

For more details on the precautions of the front view camera, refer to "Forward Collision-Avoidance Assist (FCA) (Front Camera Only) (if equipped)" on page 6-44.

High Beam Assist Setting

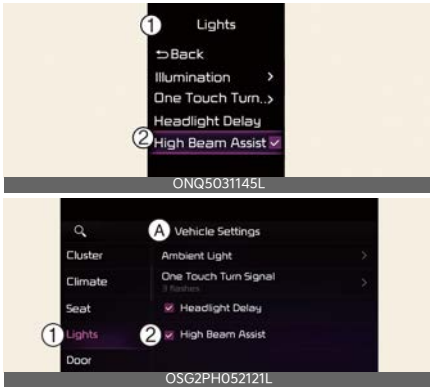

A: Vehicle Settings

1 Lights

2 High Beam Assist

With the vehicle in the ON position, select **Lights** → **High Beam Assist** from the Settings menu to turn on High Beam Assist function.

⚠ WARNING

For your safety, change the Settings after parking the vehicle at a safe location.

High Beam Assist operation

Display and control

- After selecting **HBA (High Beam Assist)** in the **Settings** menu, High Beam Assist will operate by following the procedure below.
 - Place the headlamp switch in the AUTO position and push the headlamp lever towards the instrument cluster. The High Beam Assist (HBA) indicator light will appear on the cluster and the function will be enabled.

- When the function is enabled, high beam will turn on when vehicle speed is above 40 km/h (25 mph). When vehicle speed is below 25 km/h (15 mph), high beam will not turn on. The High Beam (HBA) indicator light will appear on the cluster when high beam is on.
- When High Beam Assist is operating, if the headlamp lever or switch is used, the function operates as follow:
 - If the headlamp lever is pulled towards you when the high beam is off, the high beam will turn on. When you let go of the headlamp lever, High Beam Assist will turn on again.
 - If the headlamp lever is pulled towards you when the high beam is on, the low beam will turn on and High Beam Assist will be canceled.
 - If you push the light switch towards the instrument cluster, high beam is turned on and High Beam Assist is released.
 - If the headlamp switch is placed from AUTO to another position (headlamp/position/off), High Beam Assist will turn off and the corresponding lamp will turn on.
- When High Beam Assist is operating, high beam switches to low beam if any of the following conditions occur:
 - When the headlamp of an oncoming vehicle is detected.
 - When the tail lamp of a vehicle in front is detected.
 - When the headlamp or tail lamp of a motorcycle or a bicycle is detected.
 - When the surrounding ambient light is bright enough that high beams are not required.

- When streetlights or other lights are detected.

High Beam Assist Malfunction and limitations

High Beam Assist Malfunction

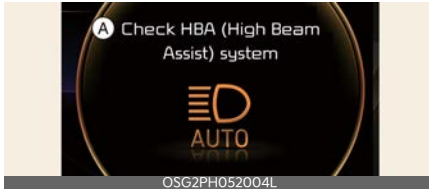

A: Check HBA (High Beam Assist) system

When High Beam Assist is not working properly, the warning message will appear and warning light (▲) will appear on the cluster. We recommend that you have your vehicle inspected by an authorized Kia dealer/service partner.

Limitations of High Beam Assist

- Light from a vehicle is not detected because of lamp damage, or because it is hidden from sight, etc.
- Headlamp of a vehicle is covered with dust, snow or water.
- A vehicle's headlamps are off but the fog lamps are on and etc.
- There is a lamp that has a similar shape as a vehicle's lamp.
- Headlamps have been damaged or not repaired properly.
- Headlamps are not aimed properly.
- Driving on a narrow curved road, rough road, uphill or downhill.
- Vehicle in front is partially visible on a crossroad or curved road.
- There is a traffic light, reflecting sign, flashing sign or mirror ahead.
- There is a temporary reflector or flash ahead (construction area).

- The road conditions are bad such as being wet, iced or covered with snow.
- A vehicle suddenly appears from a curve.
- The vehicle is tilted from a flat tire or is being towed.
- Light from a vehicle is not detected because of exhaust fume, smoke, fog, snow, etc.

* NOTICE

- Depending on the instrument cluster specifications or theme, images or colors may be displayed differently.
- For more details on the limitations of the front view camera, refer to "Forward Collision-Avoidance Assist (FCA) (Front Camera Only) (if equipped)" on page 6-44.

▲ WARNING

- At times, High Beam Assist may not work properly. The function is for your convenience only. It is the responsibility of the driver for safe driving practices and always check the road conditions for your safety.
- When High Beam Assist does not operate normally, change the headlamp position manually between high beam and low beam.

Headlamp leveling adjustment switch (if equipped)



Operation

- The higher the number of the switch position, the lower the headlamp beam level.
- Always keep the headlamp beam at the proper leveling position, or headlamps may dazzle other road users.

Loading condition	Switch position
Driver only	0
Driver + Front passenger	0
Full passengers (including driver)	1
Full passengers (including driver) + Maximum permissible loading	2
Driver + Maximum permissible loading	3

Wipers and washers

Wipers

Controlling wipers

Type A



Type B



Type C



Operation

- 1 Front wiper speed control
 - MIST/1x: Single wipe
 - **OFF** / **○**: Off
 - INT/**AUTO** *: Intermittent control wipe/Auto control wipe
 - LO/1: Low wiper speed
 - HI/2: High wiper speed
- 2 Wash with brief wipes
- 3 Rear wiper speed control
 - HI/2: Continuous wipe

- LO/1: Intermittent wipe
- **OFF** /  : Off

*: if equipped

*** NOTICE**

If there is heavy accumulation of snow or ice on the windshield, defrost the windshield for about 10 minutes, or until the snow and/or ice is removed before using the windshield wipers to ensure proper operation. If you do not remove the snow and/or ice before using the wiper and washer, it may damage the wiper and washer system.

Controlling wiper automatically (if equipped)



- A: Rain sensor
- B: Wiper speed control switch

Operation

- The rain sensor (A) senses the amount of rainfall and adjusts the wiper speed to a proper interval.
- Turn the speed control switch (B) to adjust the wiper speed.

⚠ CAUTION

- When the ignition switch or ENGINE START/STOP button is ON and the windshield wiper switch is placed in the AUTO mode, use caution in the following situations to avoid any injury to the hands or other parts of the body:

- Do not touch the upper end of the windshield glass facing the rain sensor.
- Do not wipe the upper end of the windshield glass with a damp or wet cloth.
- Do not put pressure on the windshield glass.
- When washing the vehicle, set the wiper switch in the OFF (O) position to stop the auto wiper operation. The wiper may operate and be damaged if the switch is set in the AUTO mode while washing the vehicle.
- Do not remove the sensor cover located on the upper end of the passenger side windshield glass. Damage to system parts could occur and may not be covered by your vehicle warranty.
- When starting the vehicle in winter, set the wiper switch in the OFF (O) position. Otherwise, wipers may operate and ice may damage the windshield wiper blades. Always remove all snow and ice and defrost the windshield properly prior to operating the windshield wipers.
- When tinting the windshield, be careful of any fluid getting into the sensor located in the top center of the front windshield. It may damage the related parts.

Washers

Controlling washers

Type A



Type B



Type C



⚠ CAUTION

- To prevent possible damage to the washer pump, do not operate the washer when the fluid reservoir is empty.
- To prevent possible damage to the wipers or windshield, do not operate the wipers when the windshield is dry.
- To prevent damage to the wiper blades, do not use gasoline, kerosene, paint thinner, or other solvents on or near them.
- To prevent damage to the wiper arms and other components, do not attempt to move the wipers manually.
- To prevent possible damage to the wipers and washer system, use anti-freezing washer fluids in the winter season or cold weather.

Operation

1. Move the wiper speed control switch to **OFF** / **○** position.
2. Pull/push the lever to spray washer fluid on the windshield.
3. The wipers run several times.

⚠ WARNING

Do not use the washer in freezing temperatures without first warming the windshield with the defrosters; the washer solution could freeze on the windshield and obscure your vision.

Welcome system

The surroundings or the interior will be appeared when the driver approaches or exits the vehicle.

Illuminating functions

Door handle lamp (if equipped)



Operation

- Door handle lamp will turn on for approximately 15 seconds.

Operating condition(s)

- All the doors (and tailgate) are closed and locked.

Headlamp escort function

Operation

- The headlamps remain on for approximately 5 minutes if the vehicle is in ACC or OFF position with the headlamps ON.
 - The headlamps turn off after 15 seconds if the driver door is opened and closed.

Operating condition(s)

- Vehicle is in the ACC position.
- The driver's door is opened and closed.

Interior illumination

Operation

- The room lamp will turn on.
 - For approximately 30 seconds.

Operating condition(s)

- Map lamp switch is in DOOR mode.
- All the doors (and tailgate) are closed and locked.

Interior lights

Map lamp



Type A



Type B



Operation

- Press or touch the lamp (1) to turn the map lamp ON.
-  (2): DOOR mode
-  (3): Front and rear room lamps on and off.

* INFORMATION

DOOR mode

- The map lamp and room lamp come on approximately 30 seconds.
 - When a door is opened.
 - When doors are unlocked with a smart key as long as the doors are not opened.
- The map lamp and room lamp will stay on
 - If a door is opened with the ENGINE START/STOP button in the ACC or OFF position. (5 minutes)

- If the door is opened with the ENGINE START/STOP button in the ON position. (continuously)
- The map lamp and room lamp will go out
 - If the vehicle is changed to the ON position or all doors are locked. (immediately)

* NOTICE

The DOOR mode and ROOM mode can not be selected at a time.

Room lamp (if equipped)

Type A



Type B



Operation

- Press the switch to turn the room lamp on and off.

Luggage room lamp



Operation

- Open the tailgate. The lamp will turn on.

Vanity mirror lamp (if equipped)



Operation

- ☀️: The lamp will turn on if this button is pressed.
- ○: The lamp will turn off if this button is pressed.

* NOTICE

To prevent unnecessary charging system drain, close the vanity mirror cover after using the mirror.

Glove box lamp



Operation

- The glove box lamp comes on when the glove box is opened.

* NOTICE

To prevent unnecessary charging system drain, close the glove box securely after using the glove box.

Climate control system

Climate control system components

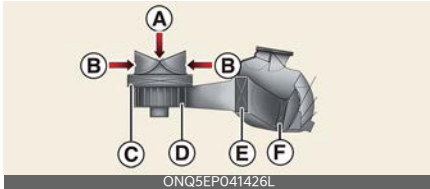

- A: Outside air
- B: Recirculated air
- C: Climate control air filter
- D: Blower
- E: Evaporator core
- F: Heater core

The climate control air filter installed behind the glove box filters the dust or other pollutants that come into the vehicle from the outside through the heating and air conditioning system.

If dust or other pollutants accumulate in the filter over a period of time, the air flow from the air vents may decrease. This leads to moisture accumulating on the inside of the windshield even when the outside (fresh) air position is selected.

If this happens, have the climate control air filter replaced by a professional workshop. Kia recommends to visit an authorized Kia dealer/service partner.

CAUTION

- **Excessive air conditioning use**
When using the air conditioning system, monitor the temperature gauge closely while driving up hills or in heavy traffic when outside temperatures are high. Air conditioning system operation may cause vehicle over-

heating. Continue to use the blower fan but turn the air conditioning system off if the temperature gauge indicates vehicle overheating.

- The air conditioning system should only be used with the windows and sunroof closed to prevent condensation inside the vehicle that may cause damage to electrical components.

*** NOTICE**

- Replace the filter according to the maintenance schedule. If the vehicle is being driven in severe conditions such as dusty or rough roads, more frequent air conditioner filter inspections and changes are required.
- When the air flow rate suddenly decreases, have the system checked by a professional workshop. Kia recommends to visit an authorized Kia dealer/service partner.

Air conditioning refrigerant label

Example Type A

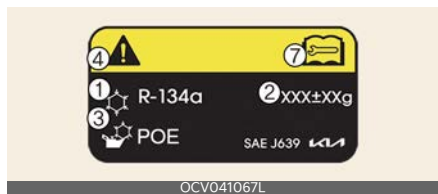

Example Type B



- 1 Classification of refrigerant

- 2 Amount of refrigerant
- 3 Classification of Compressor lubricant
- 4 Caution
- 5 Flammable Refrigerant
- 6 Registered technician to service Air Conditioning system
- 7 Service manual

You can find out which air conditioning refrigerant is applied your vehicle at the label inside of the engine compartment. Refer to "Refrigerant label" on page 9-9 for more detail.

*** INFORMATION**

- When the amount of refrigerant is low, the performance of the air conditioning is reduced. Overfilling also has a negative impact on the air conditioning system.
- If abnormal operation is found, have the system inspected by a professional workshop. Kia recommends to visit an authorized Kia dealer/service partner.

⚠ WARNING

- **Vehicles equipped with R-134a**



Because the refrigerant is at very high pressure, the air conditioning system should only be serviced by trained and certified technicians. It is important that the correct type and amount of oil and refrigerant is used.

Otherwise, it may cause damage to the vehicle and personal injury.

- **Vehicles equipped with R-1234yf***



Since the refrigerant is mildly flammable and operated at high pressure, the air conditioning system should only be serviced by trained and certified technicians.

It is important that the correct type and amount of oil and refrigerant are used. All refrigerants should be reclaimed with proper equipment. Venting refrigerants directly to the atmosphere is harmful to individuals and environment. Failure to heed these warnings can lead to serious injuries.

⚠ CAUTION

AC repair

It is important that the correct type and amount of oil and refrigerant is used, otherwise, damage to the vehicle may occur. To prevent damage, the air conditioning system in your vehicle should only be serviced by trained and certified Kia technicians.

Automatic climate control system

Type A

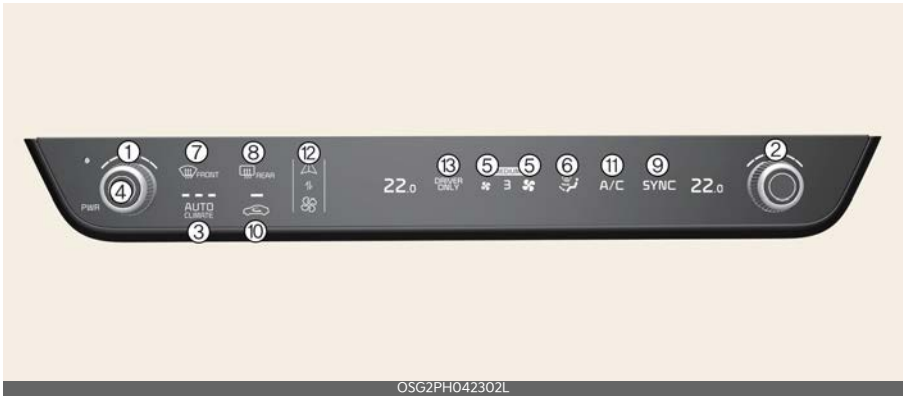

Type B



- 1 Driver's temperature control knob
- 2 Passenger's temperature control knob
- 3 AUTO (automatic control) button
- 4 OFF button
- 5 Fan speed control button
- 6 Mode selection button
- 7 Front windshield defroster button
- 8 Rear window defroster button
- 9 SYNC button
- 10 Air intake control button
- 11 Air conditioning (A/C) button
- 12 Infotainment/climate control mode switching button
- 13 Driver's side only button

CAUTION

Operating the blower when the vehicle is in the ON position could cause the battery to discharge. Operate the blower when the engine is running.

Using the infotainment/climate switchable controller control panel



Press the button on the switchable controller to switch between infotainment system or climate control panel.

Press and hold the button to select the default mode for the control panel.

Switching between panels

Infotainment control panel



Type A



Type B



Press the button on the switchable controller to select the desired control panel. The selected control panel icon will be appeared and the control panel will be changed.

- The knob display will be appeared according to the selected control panel mode.
- When the vehicle is in the ACC position, only the infotainment system will be activated.

Setting the default mode



Press and hold the button to select the default mode for the control panel.

- After the setting, the control panel will return to the default mode after a certain period of time even if the control panel is switched to the different mode.
- If the mode is set to 'OFF', the control panel will display the mode used recently.

Operating climate control system

Left-hand drive



Right-hand drive



OSG2PH042314R

Mode	Operation	Air flow
	Air flow is directed toward the upper body and face.	B, D, F
	Air flow is directed towards the face and the floor.	B, C, D, E, F
	Most of the air flow is directed to the floor, with a small amount of air directed to the windshield, side-window defrosters, and side air vents.	A, C, D, E, F
	Most of the air flow is directed to the floor and the windshield, with a small amount directed to the side-window defrosters and side air vents.	A, C, D, E, F
	Most of the air flow is directed to the windshield, with a small amount of air directed to the side-window defrosters and side air vents.	A, D

Operation

1. Start the vehicle.
2. Set the mode-selection buttons as desired. To improve the effectiveness of heating and cooling:
 - Heating: (🔥)
 - Cooling: (❄️)
3. Set the temperature control to the desired temperature level.
4. Set the air intake control to the position for outside (fresh) air if required.
5. Set the position of the fan speed control so that it runs at the desired speed.
6. If desired, turn the air conditioning ON with the temperature set high in order to dehumidify the air before it enters into the cabin.
If the windshield fogs up, select the Front Defrost (👑) mode.

Selecting air flow modes

Type A



Type B



Operation

- Select the direction of the air flow through the ventilation system.
- The air flow outlet ports are enabled in the following sequence:



Face-Level (B, D, F)

Air flow is directed toward the upper body and face. Additionally, each outlet can be controlled to direct the air discharged from the outlet.

Bi-Level (B, C, D, E, F)

Air flow is directed towards the face and the floor.

Floor-Level (A, C, D, E, F)

Most of the air flow is directed to the floor, with a small amount of the air being directed to the windshield, side window defrosters and side air vents.

Floor/Defrost-Level (A, C, D, E, F)

Most of the air flow is directed to the floor and the windshield with a small amount directed to the side window defrosters and side air vents.

Defrost-Level (A, D)

Most of the air flow is directed to the windshield with a small amount of air directed to the side window defrosters and side air vents.

Controlling air intake



Operation

- Select the outside (fresh) air position or recirculated air position.

- Outside (fresh) air position: Air enters the vehicle from outside. The indicator light will turn off.
- Recirculated air position: Air from the passenger compartment will be drawn through the heating system. The indicator light appears.

⚠ WARNING

- Continuously using the climate control system in the recirculated air position may allow humidity to increase inside the vehicle which may fog the glass and obscure visibility.
- Do not sleep in a vehicle with the air conditioning or heating system on. It may cause serious harm or death due to a drop in the oxygen level and/or body temperature.
- Continuously using the climate control system in the recirculated air position can cause drowsiness or sleepiness, and loss of vehicle control. Set the air intake control to the outside (fresh) air position as much as possible while driving.

*** NOTICE**

Prolonged operation of the heater in the recirculated air position (without air conditioning selected) may cause fogging of the windshield and side windows and make the air in the passenger compartment stale. In addition, prolonged use of the air conditioning with the recirculated air position selected will result in excessively dry air in the passenger compartment.

Controlling instrument panel vents

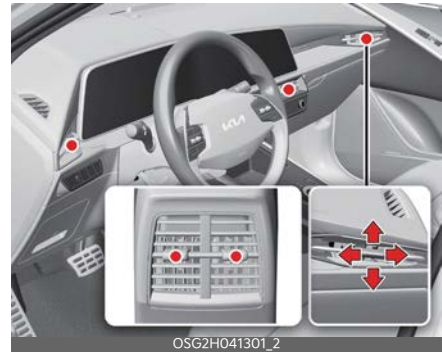

Operation

- Adjust the direction of air delivered from the vents.
- To close the vent, push the air vent lever in the opposite direction of the passenger.
- To open the vent, push the air vent lever in the same direction of the passenger.

Air conditioning (A/C)



Operation

- Press the A/C button.

Controlling heating and air conditioning automatically



Operation

1. Set the desired temperature.
2. Press the AUTO button to control:
 - Mode
 - Fan speed
 - Air intake
 - Air conditioning

Level	Indicator	LCD Display	Air flow*
High			2-8
Medium			1-6
Low			1-4

* Air flow level is not offered for European specification vehicles.

* NOTICE

- To turn the automatic operation off, select any button or switch of the following:
 - Mode selection button
 - Fan speed control button
 - Front windshield defroster button (Press the button one more time to deselect the front windshield defroster function. The AUTO sign will appear on the information display once again.)

The selected function will be controlled manually while other functions operate automatically.

- For your convenience and to improve the effectiveness of the climate control, use the AUTO button and set the temperature to 22 °C (72 °F).

Controlling temperature



Operation

- Turn the knob left or right to the desired temperature.

* NOTICE

Never place anything over the sensor located on the instrument panel to ensure better control of the heating and cooling system.

Adjusting driver and passenger side temperature equally

Type A



Type B



Operation

1. Press the 'SYNC' button.
2. Move the driver's side temperature control switch.

Changing temperature scale

Operation

- Select **Settings** → **General** → **Units** → **Temperature** on the infotainment system.

* INFORMATION

The infotainment system may change after software updates. For more information, refer to the manual provided in the infotainment system and the quick reference guide.

Controlling fan speed



Operation

- Press left or right button to adjust the speed.

Turning the fan OFF



Operation

- Press the left knob to turn the blowers off.

Climate control features

Activate upon washer fluid use (if equipped)

To prevent the odor from entering to inside the vehicle, the ventilation system changes to Recirculated Air Mode for a while when the windshield washer fluid sprayed.

Go to **Settings** → **Vehicle** → **Climate** → **Recirculate Air** → **Activate upon Washer Fluid Use** on the infotainment system.

* INFORMATION

The infotainment system may change after software updates. For more information, refer to the manual provided in the infotainment system and the quick reference guide.

Windshield defrosting and defogging

Defrosting/defogging windshield

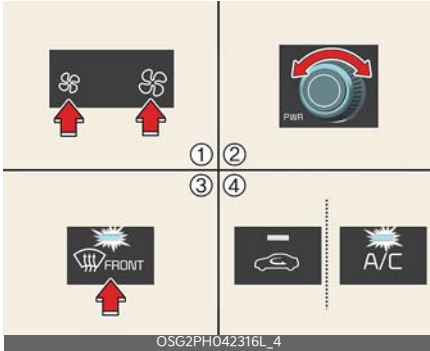

Operation

1. Set the fan speed to the desired position.
2. Select desired temperature.
3. Select (🌀) or (🌞).
4. The outside (fresh) air and air conditioning will be selected automatically.

⚠️ WARNING

Windshield heating

Do not use the (🌀) or (🌞) position during cooling operation in extremely humid weather. The difference between the temperature of the outside air and the windshield could cause the outer surface of the windshield to fog up, causing loss of visibility. In this case, set the mode selection to the (🌀) position and fan speed control to the lower speed.

Auto defogging for automatic climate control



Operation

- **For Europe**
 - Air conditioning will turn ON at recirculation mode.
 - Mode will change to defrost to direct airflow to the windshield.
 - Fan speed will increase.
- **Except Europe**
 - Air conditioning will turn ON at low temperature.
 - Air intake control will change to Fresh mode.
 - Fan speed will increase.
 - Mode will change to defrost to direct airflow to the windshield

Operating condition(s)

- When the heater or air conditioning is on.
- A high amount of humidity is detected in the vehicle.

Canceling or resetting auto defogging

Operation

- Press () for 3 seconds.
 - The button indicator will blink 3 times if canceled.
 - The button indicator will blink 6 times if reset.

* NOTICE

- When the air conditioning is turned on by Auto defogging system, if you try to turn off the air conditioning, the air conditioning will not be turned off.
- To maintain the effectiveness and efficiency of the Auto Defogging System, do not select Recirculation mode while the system is operating.
- When the Auto Defogging System is operating, the fan speed adjustment button, the temperature adjustment knob, and the air intake control button are all disabled.
- Do not remove the sensor cover located on the upper end of the driver side windshield glass.

Damage to system parts could occur and may not be covered by your vehicle warranty.

Rear window/outside mirror defroster



Operation

1. Press the rear window defroster button. The indicator appears when the defroster is ON.
2. It turns OFF after approximately 20 minutes or when the vehicle is in OFF position.

⚠ CAUTION

Conductors

To prevent damage to the conductors bonded to the inside surface of the rear window, never use sharp instruments or window cleaners containing abrasives to clean the window.

5

Resetting defogging logic

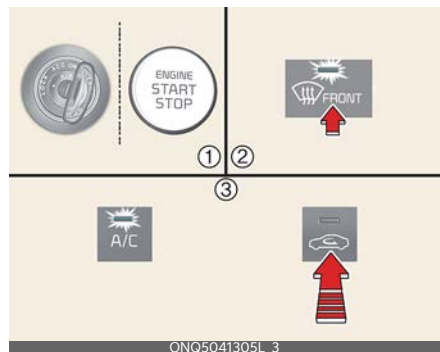

Operation

1. Turn the vehicle to the ON position.
2. Select ().
3. Within 10 seconds, press air intake button 5 times while pressing the air conditioner button (A/C).

The indicator light will blink 3 times.

Defog logic status is reset if the battery has been discharged or disconnected.

Storage compartment

Center console storage/glove box

Opening center console storage/glove box

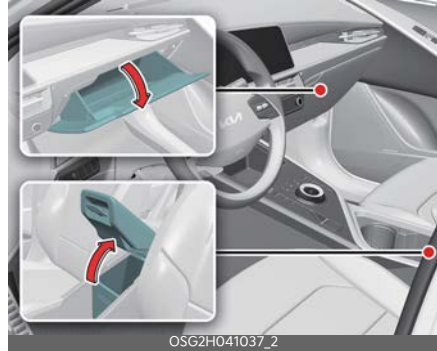

Operation

- Pull the lever upward to open the center console storage.
- Push the button of the glove box, and it will open.

WARNING

• Flammable materials

Do not store glasses, gas lighter, portable battery, canned beverage, spray can, propane cylinder, cosmetic tube or other flammable/explosive materials in the vehicle. These items may catch fire and/or explode if the vehicle is exposed to hot temperatures for extended periods.

• Glove box

To reduce the risk of injury in an accident or sudden stop, always keep the glove box door closed while driving.

⚠ CAUTION

- To avoid possible theft, do not leave valuables in the storage compartment.
- Always keep the storage compartment covers closed while driving. Do not attempt to place so many items in the storage compartment that the storage compartment cover cannot close securely.
- Do not keep food in the glove box for a long time.

Luggage board (if equipped)

- If temporary tire or full size tire equipped in luggage, you can place reflector triangle in luggage.
- If TMK equipped in luggage, first aid kit, tools, etc can be placed in the box for easy access.



1. Grasp the handle on the top of the cover and lift it.
2. Fold the rear part of luggage board frontward.
3. Lift the luggage board up.

Luggage net holder

There are 4 holders located in the cargo area. The luggage net (sold separately) can be attached in 2 ways.

⚠ WARNING

Avoid eye injury. DO NOT overstretch the luggage net, ALWAYS keep your face and body out of the luggage net's recoil path. DO NOT use when the strap has visible signs of wear or damage.

⚠ CAUTION

To prevent damage to the goods or the vehicle, care should be taken when carrying fragile or bulky objects in the luggage compartment.

Cargo security screen (if equipped)

Installing cargo security screen



- 1 Cargo security screen band
- 2 Cargo security screen cable

Operation

1. Take out the cargo security screen from the pouch. And slowly unfold the cargo security screen.
2. Attach the cargo security screen band (1) to the shopping bag hook.



3. After holding the cargo security screen cable (2), insert it into the upper hook located under the rear glass and use it to fix it.



4. Removal of the cargo screen is the reverse of assembly.

Storing cargo security screen

Operation

1. Hold the cargo screen corners of the side with the ling strings. And fold it in half.



2. Turn your wrists to fold it and put it in the pouch.



WARNING

- Do not place objects on the cargo security screen. Such objects may move around inside the vehicle and possibly injure vehicle occupants during an accident or when braking.
- Never allow anyone to ride in the luggage compartment. It is designed for luggage only.
- Maintain the balance of the vehicle and locate the weight as forward as possible.

CAUTION

Do not unfold the cargo security screen near other people. The cargo security screen could spring causing injuries.

* NOTICE

- Since the cargo security screen may be damaged or malformed, do not put luggage on it when it is used.
- Pull out the cargo security screen using the handle in the center to prevent the guide pin from falling out of the guide.
- The cargo security screen may not automatically slide back in if the cargo security screen is not fully pulled out. Fully pull it out and then let go.

Interior features

Ambient lights (if equipped)



The ambient lights are applied to the front crash pad.

Cup holders (if equipped)



Press the button to use the cup holder. Cups or small beverage cans can be placed in the cup holders. Slide the cup holder to use it as a storage area.

⚠ WARNING

• Hot liquids

- Do not place uncovered cups with hot liquid in the cup holder while the vehicle is in motion. If the hot liquid spills, you burn yourself. Such a burn to the driver could lead to loss of control of the vehicle.
- To reduce the risk of personal injury in the event of sudden stop or collision, do not place uncovered or unsecured bottles, glasses, cans, etc., in the cup holder while the vehicle is in motion.
- Keep cans or bottles out of direct sun light and do not put them in a vehicle that is heated up. It may explode.

*** NOTICE**

- Keep your drinks sealed while driving to prevent spilling your drink. If liquid spills, it may get into the vehicle's electrical/electronic system and damage electrical/ electronic parts.
- When cleaning spilled liquids, do not dry the cup holder at high temperature. This may damage the cup holder.

Ashtray (if equipped)



Use the ashtray by putting it to the cup holder.

⚠ WARNING

Ashtray use

- Do not use the vehicle's ashtrays as waste receptacles.
- Putting lit cigarettes or matches in an ashtray with other combustible materials may cause a fire.

Seat warmer/ventilation (if equipped)



The seat warmer/ventilation is provided to warm/cool the front and the rear seats.

* The seat ventilation is provided only on the front seats.

Operation

- Push the button to control the function.
- It defaults to the OFF position the vehicle is in ON position.
- The temperature setting of the seat will change as follows:

Temperature	Duration	
	Warmer	Ventilation
OFF	-	-
High	30 minutes	continuous
Medium	60 minutes	-
Low	continuous	continuous

* Rear seats does not have the medium temperature.

⚠ WARNING

Seat warmer burns

Passengers should use extreme caution when using seat warmers due to the possibility of excess heating or burns.

The seat warmer may cause burns even at low temperatures, especially if used for long periods of time. In particular, the driver must exercise extreme care for the following types of passengers:

- Infants, children, elderly or handi-capped persons, or hospital outpatients
- Persons with sensitive skin or those that burn easily
- Fatigued individuals
- Intoxicated individuals
- Individuals taking medication that can cause drowsiness or sleepiness (sleeping pills, cold tablets, etc.)

⚠ CAUTION

- When cleaning the seats, do not use an organic solvent such as paint thinner, benzene, alcohol and gasoline. Doing so may damage the surface of the heater or seats.
- To prevent overheating the seat warmer, do not place anything on the seats that insulates against heat, such as blankets, cushions or seat covers while the seat warmer is in operation.
- Do not place heavy or sharp objects on seats equipped with seat warmers. Damage to the seat warming components could occur.
- Do not change the seat cover. It may damage the seat warmer or air ventilation system.
- **Seat damage**
 - When cleaning the seats, do not use an organic solvent such as paint thinner, benzene, alcohol and gasoline. Doing so may damage the air ventilation seat.

* NOTICE

With the seat warmer button in the ON position, the heating system in the seat turns off or on automatically depending on the seat temperature.

Sun visor



Operation

1. Pull down, unsnap it from the bracket (1).
2. Swing it to the side (2).
 - Pull down the visor and slide the mirror cover (3) to use the vanity mirror.
 - The ticket holder (4) is provided for holding a tollgate ticket.

⚠ WARNING

For your safety, do not block your view when using the sun visor.

* NOTICE

Do not put several tickets in the ticket holder at one time. This could cause damage to the ticket holder.

USB charger



The USB car charger allows drivers and passengers to charge their digital devices like smartphones, and PC tablets.

* INFORMATION

- Power Delivery 3.0 is available on the smart phone or the tablet PC equipped with fast charging capabilities. It is applicable to digital devices with USB C-type. Charging speed is determined according to the charging specification of the connected digital device.
- Rated output
 - Digital device with fast charging: 9.0V / Max 3.0A
 - Digital devices with normal charging: 5.0V / Max 3.0A

⚠ CAUTION

- Use the USB car charger with the ignition on. Otherwise, Vehicle battery can be discharged.
- Use the official USB cable of the manufacturer of the digital device to be charged.
- Make sure that any foreign object, drinks, and water do not come into

contact with the USB car charger. Water or foreign object can damage the USB charger.

- Do not use the device those current consumption exceeds 2.1 A.
- Do not connect an electrical device that generates excessive electromagnetic noise to the USB car port. If you do so, noise can be caused or vehicle electronic devices can be interrupted while audio or AV is on.
- If the charger is connected incorrectly, it can cause serious damage on the devices. Please note that damages due to incorrect usage are not covered by warranty service.

AC inverter (if equipped)

Type A



Type B



The AC inverter supplies 220V/200W or 115V/150W electric power to operate electric accessories or equipment. If you wish to use the AC inverter, open up the AC inverter cover and connect a plug to it. The AC inverter supplies electric power when engine is running.

* NOTICE

- Rated voltage: AC 220V or 115V
- Maximum electric power: 200W or 150W
- In order to avoid an electrical system failure, electric shock, etc., be sure to read owner's manual before use.
- Be sure to close the cover except for when in use.
- To prevent the battery from being discharged, do not use the AC inverter while the engine is not running.
- After using an electric accessory or equipment, pull the plug out. Leaving the accessory or equipment plugged in for a long time may cause battery discharge.
- Do not use an electric accessory or equipment the power consumption of which is greater than 200W (220V) or 150W (115V).
- When the AC inverter input voltage is less than 11.3V, automatically turn off the power. AC inverter will operate as normal when the voltage is increased.
- When the AC inverter input voltage is less than 10.7V, power will turn off. The AC inverter will operate as normal when the voltage is increased.
- While the power consumption of some electrical devices/appliances may be within the AC inverter's electric power range, it may malfunction in below cases.
 - If the device/appliance requires high electric power for initial start up
 - If the device/appliance processes precise/very accurate data
 - If the device/appliance requires very stable supply of electricity

⚠ CAUTION

Electric accessory devices

- Do not use broken electric accessories which may damage the AC inverter and electrical systems of the vehicle.
- Do not use two or more electric accessories at the same time. It may cause damage to the electrical systems of the vehicle.

Power outlet



The power outlet allows drivers and passengers to charge their digital devices like smartphones, and PC tablets.

Operating condition(s)

- The devices should draw less than 15 A when the vehicle is in ON position.

⚠ WARNING

- Use the power outlet only when the vehicle is on and remove the accessory plug after use. Using the accessory plug for prolonged periods of time with the vehicle off could cause the battery to discharge.
- Only use 12 V electric accessories which are less than 15 A in electric capacity.
- Adjust the air-conditioner or heater to the lowest operating level when using the power outlet.
- Close the cover when not in use.
- Some electronic devices can cause electronic interference when plugged

into a vehicle's power outlet. These devices may cause excessive audio static and malfunctions in other electronic systems or devices used in your vehicle.

- Push the plug in as far as it will go. If good contact is not made, the plug may overheat and the fuse may open.
- Plug in battery equipped electronic devices with reverse current protection. The current from the battery may flow into the vehicle's electrical/electronic system and cause system malfunction.
- **Electric shock**
Do not put a finger or a foreign object (pen, etc.) into a power outlet and do not touch with a wet hand. You may get an electric shock.

Wireless smart phone charging system (if equipped)



- A: Indicator
- B: Charging pad

Operation

- Place the smart phone on the center of the wireless charging pad.
- The indicator light will change to orange once the wireless charging begins. The light will change to green when the charging is complete.
- You can choose to turn the wireless charging function ON or OFF from the Settings menu.

Operating condition(s)

- The wireless charging system is designed for one smart phone equipped with Qi only.

* INFORMATION

- If the wireless charging does not work, gently move your smart phone around the pad until the charging indicator light turns orange. Depending on the smart phone, the charging indicator light may not turn green even after the charging is complete.
- If the wireless charging is not functioning properly, the orange light will blink and flash for ten seconds then turn off. In such cases, remove the smart phone from the pad and replace it on the pad again, or double check the charging status.
- The system warns you with a message on the instrument cluster if the smart phone is still on the wireless charging unit after the vehicle is turned OFF and the front door is opened.

⚠ WARNING

If any metallic object such as coins is located between the wireless charging system and the smart phone, the charging may be disrupted. Also, the metallic object may heat up.

⚠ CAUTION

- When the interior temperature of the wireless charging system rises above a set temperature, the wireless charging will cease to function. After the interior temperature drops below the threshold, the wireless charging function will resume.

- If there is any metallic object between the smart phone and the wireless charging pad, immediately remove the smart phone. Remove the metallic object after it has completely cooled down.
- The wireless charging may not function properly when there is a heavy accessory cover on the smart phone.
- The wireless charging will stop when using the wireless smart key search function to prevent radio wave disruption.
- The wireless charging will stop when the smart key is moved out of the vehicle with the ignition in ON.
- The wireless charging will stop when any of the doors is opened (applicable for vehicles equipped with smart keys).
- The wireless charging will stop when the vehicle is turned OFF.
- The wireless charging will stop when the smart phone is not in complete contact with the wireless charging pad.
- Items equipped with magnetic components such as credit card, telephone card, bankbook, any transportation ticket and such may become damaged during wireless charging.
- Place the smart phone on the center of the charge pad for best results. The smart phone may not charge when placed near the rim of the charging pad. When the smart phone does get charged, it may heat up excessively.
- For smart phones without built-in wireless charging system, an appropriate accessory has to be equipped.
- Smart phones of some manufacturers may display messages on weak current. This is due to the particular characteristic of the smart phone and does not imply a malfunction on wireless charging function.
- The indicator light of some manufacturers' smart phones may still be orange after the smart phone is fully charged. This is due to the particular characteristic of the smart phone and not a malfunction of the wireless charging.
- When any smart phone without a wireless charging function or a metallic object is placed on the charging pad, a small noise may sound. This small sound is due to the vehicle discerning compatibility of the object placed on the charging pad. It does not affect your vehicle or the smart phone in any way.
- The wireless cellular phone charging system may not support certain cellular phones, which are not verified for the Qi specification (Qi).
- For certain cellular phones with their own protection, the wireless charging speed may decrease and the wireless charging may stop.

* NOTICE

For some manufacturers' smart phones, the system may not warn you even though the smart phone is left on the wireless charging unit. This is due to the particular characteristic of the smart phone and not a malfunction of the wireless charging.

Coat hook

A coat hook is located on the rear grab handle.

⚠️ WARNING

Do not hang other objects such as hangers or hard objects except clothes. Also, do not put heavy, sharp or breakable objects in the clothing's pockets. In an accident or when the curtain air bag is inflated, it may cause vehicle damage or body injury.

⚠️ CAUTION

Hanging clothing

Do not hang heavy clothes, since they may damage the hook.

films on carpets may damage or break floor mat fix rings, resulting in the mats to be unsecured

Especially for a driver's seat, the unsecured mats may cause unintended acceleration/brake. Ensure to remove all the plastic films on the carpets before installing the mats.

Floor mat anchors



Make sure the floor mat attaches to the anchors to keep the floor mat from sliding forward.

⚠️ WARNING

- **After market floor mat**
 - Do not install after market floor mats that are not capable of being securely attached to the vehicle's floor mat anchors. Unsecured floor mats can interfere with pedal operation.
- Use floor mats not too thick and designed to be properly secured on the floor to avoid the interference with pedals. Make sure that installing the floor mats without removing plastic

Exterior features

Roof rack (if equipped)



You can load cargo on top of your vehicle.

⚠ WARNING

- The following specification is the maximum weight that can be loaded onto the roof rack. Distribute the load as evenly as possible across the crossbars (if equipped) and roof rack and secure the load firmly.

ROOF LOAD	100 kg (220 lbs.) EVENLY DISTRIBUTED
-----------	---

Loading cargo or luggage in excess of the specified weight limit on the roof rack may damage your vehicle.

- The vehicle center of gravity will be higher when items are loaded onto the roof rack. Avoid sudden starts, braking, sharp turns, abrupt maneuvers or high speeds that may result in loss of vehicle control or rollover resulting in an accident.
- Always drive slowly and turn corners carefully when carrying items on the roof rack. Severe wind updrafts, caused by passing vehicles or natural causes, can cause sudden upward pressure on items loaded on the roof rack. This is especially true when carrying large, flat items such as wood panels or mattresses. This could cause the items to fall off the roof

rack and cause damage to your vehicle or others around you.

- To prevent damage or loss of cargo while driving, check frequently before or while driving to make sure the items on the roof rack are securely fastened.

⚠ CAUTION

- When carrying cargo on the roof rack, take the necessary precautions to make sure the cargo does not damage the roof of the vehicle.
- When carrying large objects on the roof rack, make sure they do not exceed the overall roof length or width.
- When you are carrying cargo on the roof rack, do not operate the sunroof. (if equipped)

*** NOTICE**

- The crossbars (if equipped) should be placed in the proper load carrying positions prior to placing items onto the roof rack.
- If the vehicle is equipped with a sunroof, be sure not to position cargo onto the roof rack in such a way that it could interfere with sunroof operation.
- When the roof rack is not being used to carry cargo, the crossbars may need to be repositioned if wind noise is detected.

Infotainment system

Using the infotainment/climate switchable controller



Press the button on the switchable controller to switch between infotainment system or climate control panel.

Press and hold the button to select the default mode for the control panel.

Switching between panels

Infotainment control panel



Type A



Type B



Press the button on the switchable controller to select the desired control panel. The selected control panel icon will be appeared and the control panel will be changed.

- The knob display will be appeared according to the selected control panel mode.
- When the vehicle is in the ACC position, only the infotainment system will be activated.

Setting the default mode



Press and hold the button to select the default mode for the control panel.

- After the setting, the control panel will return to the default mode after a certain period of time even if the control panel is switched to the different mode.
- If the mode is set to 'OFF', the control panel will display the mode used recently.

Audio system

Antenna



- Shark-fin Antenna
 - The shark-fin antenna transmits and receives wireless signals such as AM/FM, DAB, GNSS, LTE etc.
- * The signals which antenna can transmit and receive vary by the vehicle option.

⚠ CAUTION

- Be careful of antenna damage by checking the height of the vehicle before entering low-ceiling spaces such as automated parking lots or automated washing machines.
- Be careful not to contact the antenna when loading cargo on the roof rack. Antenna transmission/reception performance may be degraded.

USB port

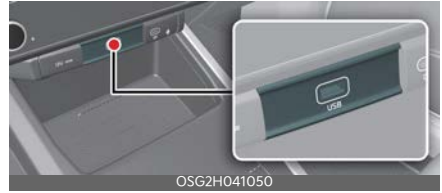

You can use the USB port to plug in an USB.

⚠ WARNING

Cell phone use

Do not use a cellular phone while driving. Stop at a safe location to use a cellular phone.

⚠ CAUTION

- Depending on the size, length, or shape of the USB stick, if you forcibly close the tray cover, the USB device may be damaged or deformed or the cover may not reopen as the device is stuck. When the stick is stuck, forcibly opening the cover can also cause damage to the device. If the USB stick does not fit into the space, do not close the cover and try another USB stick with different specifications.
- When using a communication system such as a cellular phone or a radio set inside the vehicle, a separate external antenna must be fitted. When a cellular phone or a radio set is used with only the internal antenna, it may interfere with the vehicle's electrical system and adversely affect the safe operation of the vehicle.

How vehicle radio works

FM reception

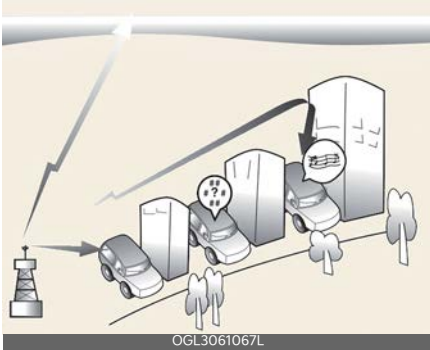

AM and FM radio signals are broadcast from transmitter towers located around your city. They are intercepted by the radio antenna on your vehicle. This signal is then processed by the radio and sent to your vehicle speakers.

However, in some cases the signal coming to your vehicle may not be strong and clear.

This can be due to factors, such as the distance from the radio station, closeness of other strong radio stations or the presence of buildings, bridges or other large obstructions in the area.

AM reception

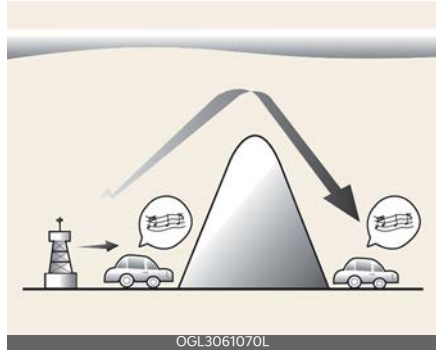

AM broadcasts can be received at greater distances than FM broadcasts. This is because AM radio waves are transmitted at low frequencies. These long distance, low frequency radio waves can follow the curvature of the earth rather than traveling straight. In addition, they curve around obstructions resulting in better signal coverage.

FM radio station

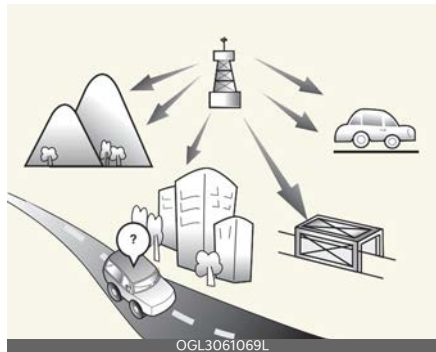

FM broadcasts are transmitted at high frequencies and do not bend to follow the earth's surface. Because of this, FM broadcasts generally begin to fade within short distances from the station. Also, FM signals are easily affected by buildings, mountains, and obstructions.

This can lead to undesirable or unpleasant listening conditions which might lead you to believe a problem exists with your radio.

The following conditions are normal and do not indicate radio trouble:

- Fading - As your vehicle moves away from the radio station, the signal will weaken and sound will begin to fade. When this occurs, we suggest that you select another station with a stronger signal.

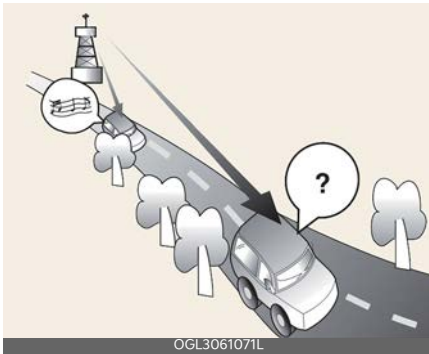

- Flutter/Static - Weak FM signals or large obstructions between the transmitter and your radio can disturb the signal causing static or fluttering noises to occur. Reducing the treble level may lessen this effect until the disturbance clears.
- Station Swapping - As an FM signal weakens, another more powerful signal near the same frequency may begin to play. This is because your radio is designed to lock onto the clearest signal. If this occurs, select another station with a stronger signal.

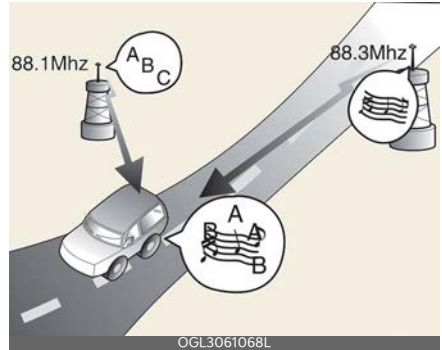

- Multi-Path Cancellation - Radio signals being received from several directions can cause distortion or fluttering. This can be caused by a direct and reflected signal from the same station, or by signals from two stations with close frequencies. If this occurs, select another station until the condition has passed.

Using a cellular phone or a two-way radio

When a cellular phone is used inside the vehicle, noise may be produced from the audio system. This does not mean that something is wrong with the audio equipment. In such a case, try to operate mobile devices as far from the audio equipment as possible.

⚠ CAUTION

When using a communication system such as a cellular phone or a radio set inside the vehicle, a separate external antenna must be fitted. When a cellular phone or a radio set is used with only the internal antenna, it may interfere with the vehicle's electrical system and adversely affect the safe operation of the vehicle.

 **WARNING**

Cell phone use

Do not use a cellular phone while driving. Stop at a safe location to use a cellular phone.

Before driving	6-6
• Necessary vehicle inspections.....	6-6
• Good driving practices	6-7
• Good braking practices.....	6-8
Starting the vehicle	6-9
• Ignition switch.....	6-9
• ENGINE START/STOP button	6-10
• Starting the engine.....	6-12
Transmission	6-13
• Dual clutch transmission.....	6-13
• LCD display messages.....	6-18
Paddle shifter	6-23
• Manual mode.....	6-23
• Regenerative braking mode.....	6-23
Smart regeneration system	6-25
• Setting smart regeneration system.....	6-25
• Smart regeneration system activation	6-26
• Resuming smart regeneration system	6-27
• Basic setting of smart regeneration system	6-27
• Vehicle-to-vehicle distance recognition sensor	6-27
• System malfunction	6-28
• Limitations of the system	6-28
Brake system	6-31
• In the event of brake failure.....	6-31
• Parking brake	6-32
• Brake Disc Cleaning (BDC)	6-35
• AUTO HOLD	6-35
Vehicle safety system	6-37
• Anti-lock Brake System (ABS)	6-37
• Electronic Stability Control (ESC).....	6-37

6 Driving your vehicle

• Hill-start Assist Control (HAC)	6-38
• Multi-Collision Brake (MCB)	6-38
• Vehicle Stability Management (VSM)	6-39
• Emergency Stop Signal (ESS)	6-39
• Brake Assistant System (BAS)	6-40
Drive mode integrated control system	6-41
• DRIVE MODE	6-41
Active air flap	6-42
• Active air flap malfunction	6-42
Green Zone Drive Mode for Europe	6-43
• Green Zone Drive Mode LCD display	6-43
• Green zone registration point	6-43
Forward Collision-Avoidance Assist (FCA) (Front Camera Only)	6-44
• Forward Collision-Avoidance Assist settings	6-44
• Forward Collision-Avoidance Assist operation	6-46
• Forward Collision-Avoidance Assist malfunction and limitations	6-48
Forward Collision-Avoidance Assist (FCA) (Sensor Fusion) .	6-53
• Forward Collision-Avoidance Assist settings	6-55
• Forward Collision-Avoidance Assist operation	6-57
• Forward Collision-Avoidance Assist malfunction and limitations	6-59
Lane Keeping Assist (LKA)	6-65
• Lane Keeping Assist settings	6-65
• Lane Keeping Assist operation	6-66
• Lane Keeping Assist malfunction and limitations	6-68
Blind-Spot Collision-Avoidance Assist (BCA)	6-70
• Blind-Spot Collision-Avoidance Assist settings	6-72
• Blind-Spot Collision-Avoidance Assist operation	6-73

- Blind-Spot Collision-Avoidance Assist malfunction and limitations 6-75
- Safe Exit Warning (SEW) 6-79**
 - Safe Exit Warning settings 6-80
 - Safe Exit Warning operation 6-80
 - Safe Exit Warning malfunction and limitations 6-81
- Safe Exit Assist (SEA) 6-83**
 - Safe Exit Assist settings 6-83
 - Safe Exit Assist operation 6-84
 - Safe Exit Assist malfunction and limitations 6-85
- Manual Speed Limit Assist (MSLA) 6-87**
 - Manual Speed Limit Assist operation 6-87
- Intelligent Speed Limit Assist (ISLA) 6-89**
 - Intelligent Speed Limit Assist settings 6-89
 - Intelligent Speed Limit Assist operation 6-91
 - Intelligent Speed Limit Assist malfunction and limitations 6-92
- Driver Attention Warning (DAW) 6-94**
 - Driver Attention Warning settings 6-95
 - Driver Attention Warning operation 6-95
 - Driver Attention Warning malfunction and limitations 6-97
- Cruise Control (CC) 6-99**
 - Cruise Control operation 6-99
- Smart Cruise Control (SCC) 6-102**
 - Smart Cruise Control settings 6-103
 - Smart Cruise Control operation 6-103
 - Smart Cruise Control malfunction and limitations 6-110
- Navigation-based Smart Cruise Control (NSCC) 6-114**
 - Navigation-based Smart Cruise Control settings 6-115
 - Navigation-based Smart Cruise Control operation 6-115
 - Limitations of Navigation-based Smart Cruise Control 6-117

6 Driving your vehicle

Lane Following Assist (LFA)	6-120
• Lane Following Assist settings	6-120
• Lane Following Assist operation	6-121
• Lane Following Assist malfunction and limitations.....	6-122
Highway Driving Assist (HDA)	6-123
• Highway Driving Assist settings	6-123
• Highway Driving Assist operation	6-124
• Highway Driving Assist malfunction and limitations.....	6-126
Rear View Monitor (RVM)	6-128
• Rear View Monitor settings	6-128
• Rear View Monitor operation.....	6-130
• Rear View Monitor malfunction and limitations.....	6-131
Rear Cross-Traffic Collision-Avoidance Assist (RCCA)	6-132
• Rear Cross-Traffic Collision-Avoidance Assist settings	6-132
• Rear Cross-Traffic Collision-Avoidance Assist operation.....	6-133
• Rear Cross-Traffic Collision-Avoidance Assist malfunction and limitations.....	6-136
Reverse Parking Distance Warning (PDW)	6-140
• Reverse Parking Distance Warning settings.....	6-140
• Reverse Parking Distance Warning operation.....	6-141
• Reverse Parking Distance Warning malfunction and precautions.....	6-141
Forward/Reverse Parking Distance Warning (PDW)	6-143
• Forward/Reverse Parking Distance Warning settings.....	6-144
• Parking Distance Warning operation	6-145
• Parking Distance Warning malfunction and limitations	6-146
Reverse Parking Collision-Avoidance Assist (PCA)	6-148
• Parking Collision-Avoidance Assist settings	6-148
• Parking Collision-Avoidance Assist operation.....	6-150
• Parking Collision-Avoidance Assist malfunction and limitations.....	6-151

Remote Smart Parking Assist (RSPA)	6-155
• Remote Smart Parking Assist settings	6-156
• Remote Smart Parking Assist operation	6-157
• Remote Smart Parking Assist malfunction and limitations.....	6-161
Declaration of conformity	6-165
Economical operation	6-173
Special driving conditions	6-173
Winter driving	6-177
Trailer towing	6-180
• Hitches	6-181
• Safety chains.....	6-182
• Trailer brakes.....	6-182
• Driving with a trailer.....	6-182
• Maintenance when trailer towing	6-184
• If you do decide to pull a trailer.....	6-185
Vehicle weight	6-187
• Base curb weight.....	6-187
• Vehicle curb weight.....	6-187
• Cargo weight.....	6-187
• GAW (Gross axle weight).....	6-187
• GAWR (Gross axle weight rating)	6-187
• GVW (Gross vehicle weight).....	6-187
• GVWR (Gross vehicle weight rating)	6-187
• Overloading.....	6-187
• Loading Your Vehicle - For Australia	6-187

Driving your vehicle

Before driving

Necessary vehicle inspections

Be sure to check the following fluid levels on a regular basis at the exact interval:

- Engine oil
- Engine coolant
- Brake fluid
- Washer fluid

For more details, refer to "Maintenance" on page 8-4.

⚠ WARNING

Focus on the road while driving. The driver's primary responsibility is in the safe and legal operation of a vehicle. Any use of handheld devices, other equipment, or vehicle systems that take the driver's eyes, attention, and focus away from the safe operation of a vehicle are not permissible by law. These should never be used during the operation of the vehicle.

Checking the exhaust system

Be sure the exhaust system does not leak.

The exhaust system should be checked whenever the vehicle is raised for oil replacement or for any other purpose. If you hear a change in the exhaust sound or if something strikes the undercarriage, Kia recommends to visit an authorized Kia dealer/service partner or a professional workshop and have the exhaust system checked as soon as possible.

⚠ WARNING

Do not inhale exhaust fumes or leave your engine running in an enclosed area for a prolonged time. Exhaust fumes contain carbon monoxide, a colorless and odorless gas that can cause unconsciousness and death by asphyxiation.

Before entering vehicle

- Be sure that all windows, outside mirrors, and outside lights are clean.
- Check the condition of the tires.
- Check under the vehicle for any sign of leaks.
- Be sure there are no obstacles behind you if you intend to back up.

Before starting vehicle

- Close and lock all doors.
- Position the seat so that all controls are easily reached.
- Buckle your seat belt.
- Adjust both inside and outside rear view mirrors.
- Be sure that all lights work.
- Check all gauges.
- Check the operation of warning lights when the vehicle is in the ON position.
- Release the parking brake and make sure the brake warning light is off.

⚠ WARNING

- When you intend to park or stop the vehicle with the engine on, be careful not to depress the accelerator pedal for a long period of time. It may overheat the engine or exhaust system and cause fire.
- Always check the surrounding areas near your vehicle for people, especially children, before putting a vehicle into D (Drive) or R (Reverse).

- Securely store items in your vehicle. When you make a sudden stop or turn the steering wheel rapidly, loose objects may drop on the floor and it could interfere with the operation of the foot pedals, possibly causing an accident.
- Do not drive while under the influence of alcohol, drugs, or other impairing substances. Drinking and driving is dangerous. Even a small amount of alcohol will affect your reflexes, perceptions and judgment.
Driving while under the influence of drugs or other impairing substances is as dangerous as or more dangerous than driving drunk.
- Always wear appropriate shoes when operating your vehicle. Unsuitable shoes (high heels, ski boots, sandals, etc.) may interfere with your ability to use the brake and accelerator pedals.
- Always use the parking brake. Do not depend on P (Park) to keep the vehicle from moving.
- Exercise extreme caution when driving on a slippery surface. Be especially careful when braking, accelerating or shifting gears. The vehicle speed can change abruptly, causing the tires to lose traction and the vehicle go out of control.
- Obtain the optimum vehicle performance by driving smoothly.

WARNING

- If your vehicle becomes stuck in snow, mud, sand, etc., then you may attempt to rock the vehicle free by moving it forward and backward. Do not attempt this procedure if people or objects are anywhere near the vehicle. During the rocking operation the vehicle may suddenly move forward or backward as it becomes unstuck, causing injury or damage to nearby people or objects.
- When driving uphill or downhill, always shift to D (Drive) for driving forward or shift to R (Reverse) for driving backwards, and check the gear position indicated on the cluster before driving. Driving in the opposite direction of the selected gear can lead to a dangerous situation by shutting off the engine and affecting the braking performance.
- Always buckle-up! In a collision, an unbelted occupant is significantly more likely to be seriously injured or killed than a properly belted occupant.
- Avoid high speeds when cornering or turning.

Good driving practices

- Never change the gear from P (Park) or N (Neutral) to any other position with the accelerator pedal depressed.
- Never change the gear into P (Park) when the vehicle is moving.
- Stop the vehicle completely before changing the gear into R (Reverse) or D (Drive).
- Never change the gear to N (Neutral) and coast down the hill. This is extremely hazardous. Always change the gear to R (Reverse) or D (Drive) when the vehicle is moving.
- Do not "ride" the brakes. It may cause the brake to overheat and malfunction. Use the engine brake to drive down the long hill.
- Slow down before shifting to a lower gear.

- Do not make quick steering wheel movements, such as sharp lane changes or fast, sharp turns.
- The risk of a rollover is greatly increased if you lose control of your vehicle at highway speeds.
- Losing control often occurs if two or more wheels drop off the roadway and the driver oversteers to reenter the roadway.
- In the event your vehicle leaves the roadway, do not steer sharply. Instead, slow down before pulling back into the travel lanes.
- Never exceed posted speed limits.

Good braking practices

- Be sure the parking brake is not engaged and the parking brake indicator light is off before driving.
 - The vehicle will not stop as quickly if the brakes are wet. Apply the brakes lightly until the braking action returns to normal.
 - Don't "ride" the brake pedal. Resting your foot on the brake pedal while driving can be dangerous because the brakes might overheat and lose their effectiveness. It also increases the wear of the brake components.
 - If a tire goes flat while driving, apply the brakes gently and keep the vehicle pointed straight-ahead while slowing down the vehicle. Pull the vehicle slowly and safely off the road and stop in a safe place.
 - Be cautious when parking on a hill. Firmly engage the parking brake and change the gear in P.
 - If your vehicle is facing downhill, turn the front wheels into the curb to help keep the vehicle from rolling.
- If your vehicle is facing uphill, turn the front wheels away from the curb to help keep the vehicle from rolling.
- Block the wheels if there is no curb or if it is required by other conditions to keep the vehicle from rolling.
 - Parking brake can freeze in the engaged position under certain conditions such as snow or ice around or near the rear brakes or if the brakes are wet.
- If there is a risk that the parking brake may freeze, apply it only temporarily while you change the gear in P and block the rear wheels so the vehicle cannot roll. Then release the parking brake.
- Do not hold the vehicle on an incline with the accelerator pedal. This can cause the transmission to overheat. Always use the brake pedal or parking brake.
 - Do not pump the brake pedal as the vehicle is equipped with ABS.
 - When the brake pedal is depressed under certain driving conditions or weather conditions, the vehicle may experience a temporary "squeak" or other noise. This is not a malfunction in brake operation and is normal.
 - Driving on roads with snow removal agents can cause brake noise or abnormal wear on tires. Set the regenerative braking system level to "0" in a safe traffic environment and apply the brakes several times to remove the snow removal agent from the brake discs and pads.
 - The vehicle is equipped with electronic hydraulic brake. Due to malfunction or power instability, the brake booster may not operate normally and cause the brake pedal to

feel stiff, resulting in longer braking distances. In this case, stop the vehicle by depressing the brake pedal stronger than usual. Have the system inspected by a professional workshop. Kia recommends visiting an authorized Kia dealer/service partner.

- The sound of electronic hydraulic brake operating or its motor may be heard temporarily when:
 - Repeatedly depressing the brake pedal
 - Releasing the brake pedal after depressing the brake pedal when the engine is off.
 - Opening driver's door
- The brake pedal may feel abnormal when:
 - Rapidly depressing the brake pedal
 - Repeatedly depressing the brake pedal several times
 - ABS operates when stopping

Starting the vehicle

Ignition switch (if equipped)



- 1 LOCK
- 2 ACC
- 3 ON
- 4 START

Operation

- LOCK
 - The ignition key can be removed.
- ACC (Accessory)
 - The electrical accessories can be operated.
- ON
 - The warning lights can be checked.
- START
 - Turn the ignition switch to start the engine. The brake warning light can be checked.

⚠ WARNING

- Never turn the ignition switch to LOCK or ACC while the vehicle is moving. This would result in loss of directional control and braking function, which could cause an accident.
- Do not attach small purses, multiple keys, or any other heavy accessories to the driver's key chain used to start the vehicle. This may cause the driver to accidentally make the key inserted in the vehicle to change the ignition position to the ACC position while the vehicle is moving thereby increasing

the risk of an accident and causing the deactivation of several safety features.



- NEVER reach through the steering wheel for the ignition switch, or any other control, while the vehicle is in motion. The presence of your hand or arm in this area may cause a loss of vehicle control resulting in an accident.
- Do not place movable objects by the driver's seat. Not only does it interfere with driving, but it could also cause an accident.
- To avoid unexpected or sudden vehicle movement, never leave your vehicle if the gear is not locked in the P (Park) position and the parking brake is fully engaged. Before leaving the driver's seat, always make sure the gear is shifted to P (Park) position, set the parking brake fully and shut the engine off.

* NOTICE

If you leave the ignition switch to the ACC or ON position for a long time, the battery may discharge.

ENGINE START/STOP button (if equipped)



Operation

- OFF
 - Press the ENGINE START/STOP button in P to turn the vehicle off.
- ACC (Accessory)
 - Press the ENGINE START/STOP button once without depressing the brake pedal.
 - The electrical accessories can be operated.
 - Turns off automatically after approximately 1 hour to prevent battery discharge.
- ON
 - Press the ENGINE START/STOP button twice without depressing the brake pedal.
 - The warning lights can be checked.
- START/RUN
 - Press the ENGINE START/STOP button while depressing the brake pedal in P (Park).
 - Start the engine in P for the safety.

⚠ WARNING

- Never press the ENGINE START/STOP button while the vehicle is in motion. This would result in loss of directional control and braking function, which could cause an accident.
- Before leaving the driver's seat, always make sure the gear is shifted

to P (Park) position, set the parking brake fully and shut the engine off. Unexpected and sudden vehicle movement may occur if these precautions are not taken.

- Never reach for the ENGINE START/STOP button or any other controls through the steering wheel while the vehicle is in motion. The presence of your hand or arm in the area could cause loss of vehicle control, an accident and serious bodily injury or death.
- Do not place any movable objects around the driver's seat as they may move while driving, interfere with the driver and lead to an accident.

* NOTICE

- If you leave the ENGINE START/STOP button in the ACC or ON position for a long time, the battery will discharge.
- If you press the ENGINE START/STOP button without pressing the brake pedal, the engine will not start and the ENGINE START/STOP button changes as follow:
 - OFF → ACC → ON → OFF or ACC

ENGINE START/STOP button interlock system (if equipped)

The ENGINE START/STOP button will not change to the OFF position unless the vehicle is in P (Park).

Vehicles equipped with anti-theft steering column lock

ENGINE START/STOP button interlock system (if equipped)

- The vehicle is in the OFF position
- The doors are opened

⚠ CAUTION

In an emergency situation while the vehicle is in motion, you are able to turn the engine off and to the ACC position by pressing the ENGINE START/STOP button for more than 2 seconds or 3 times repeatedly within 3 seconds

If the vehicle is still moving, to restart the vehicle:

- Press the ENGINE START/STOP button when vehicle speed is 5 km/h (3 mph) or over

* NOTICE

- If the steering wheel doesn't unlock properly, the ENGINE START/STOP button will not work. Press the ENGINE START/STOP button while turning the steering wheel right and left to release the tension.
- You are able to turn off the engine (START/RUN) or vehicle power (ON), only when the vehicle is not in motion.

Starting the engine with smart key

The vehicle will check for the smart key when:

- The vehicle doors are opened
- The ENGINE START/STOP button is pressed

If the smart key is not in the vehicle, the indicator () and the message will appear on the instrument cluster.

⚠ WARNING

The engine will start, only when the smart key is in the vehicle. Never allow children or any person who is unfamiliar with the vehicle touch the ENGINE START/STOP button or related parts. Pushing the ENGINE START/STOP but-

ton while the smart key is in the vehicle may result in unintended engine activation and/or unintended vehicle movement.

⚠ CAUTION

- If the engine stalls while the vehicle is in motion, do not attempt to move the gear to the P (Park) position. If the traffic and road conditions permit, you may put the gear in the N (Neutral) position while the vehicle is still moving and press the ENGINE START/STOP button in an attempt to restart the engine.
- Do not press the ENGINE START/STOP button for more than 10 seconds except when the stop lamp fuse is blown.
- Do not turn the ignition switch to the START position with the engine running. It may damage the starter.
- You can also start the engine when the gear is in the N (neutral) position, but for safety, be sure to start the engine only when the gear is in the P (Park) position.

* NOTICE

- If the battery is weak or the smart key does not work correctly, you can start the engine by pressing the ENGINE START/STOP button with the smart key. When you press the ENGINE START/STOP button directly with the smart key, the smart key should contact the button at a right angle.



- When the stop lamp fuse is blown, you cannot start the engine normally. Replace the fuse with a new one. If it is not possible, you can start the engine by pressing the ENGINE START/STOP button for 10 seconds while it is in the ACC position. The engine can start without pressing the brake pedal. But for your safety always press the brake pedal before starting the engine.

Starting the engine

⚠ WARNING

- Always wear appropriate shoes when operating your vehicle. Unsuitable shoes (high heels, ski boots, etc.) may interfere with your ability to use the brake and accelerator pedal.
- Do not start the vehicle with the accelerator pedal depressed. The vehicle can move and lead to an accident.
- Wait until the engine rpm is normal. The vehicle may suddenly move if the brake pedal is released when the rpm is high.

Starting the gasoline engine

Operation

1. Make sure the parking brake is applied.
2. Make sure the gear is in P (Park).
3. Fully depress the brake pedal.
4. Turn the key to START position or press the ENGINE START/STOP button.

Transmission

Dual clutch transmission (if equipped)

Shift lever type

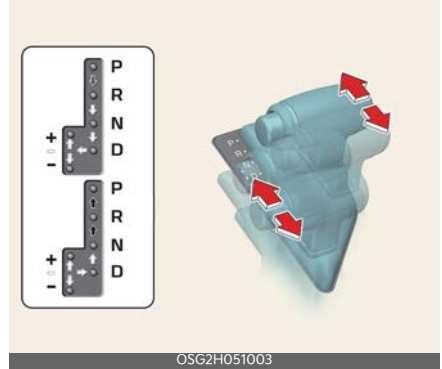

▬➡ Depress the brake pedal and the lock release button when shifting.

➡ Press the unlock button when shifting.

⇨ The shift lever can be shifted freely.

- P (Park)
- R (Reverse)
- N (Neutral)
- D (Drive)

Operation

- Depress the brake pedal and shift the lever.

Manual mode



Operation

1. Push the shift lever from D (Drive) position into the manual gate.
 - Up (+): Push the lever forward once to shift up one gear.
 - Down (-): Pull the lever backwards once to shift down one gear.
2. Push the shift lever back into D (Drive) position to return to automatic mode.

Shift lock

Shift lock prevents shifting from P (Park) into R (Reverse) unless the brake pedal is depressed.

Operation

1. Depress and hold the brake pedal.
2. Turn the vehicle to the ON position.
3. Move the shift lever.

* INFORMATION

If the brake pedal is repeatedly depressed and released with the shift lever in the P (Park), a chattering noise near the shift lever may be heard. This is a normal condition.

Overriding shift lock

If the shift lever cannot be moved from the P (Park) position into R (Reverse) position.

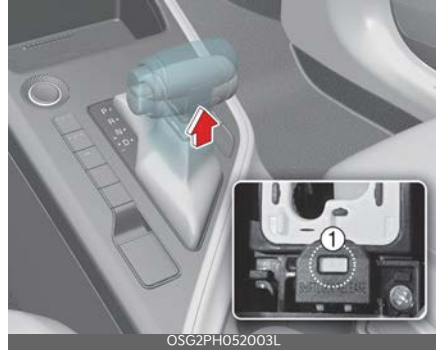

Operation

1. Continue depressing the brake.
2. Turn the vehicle to the OFF position.
3. Make sure the parking brake is applied.
4. Carefully remove the shift knob boot.
5. Insert a tool (e.g. flathead screwdriver) into the access hole and press down on the tool.
6. Move the shift lever.
7. Remove the tool from the shift lock override access hole then install the knob boot (1).

If the shift lever does not move even after performing this procedure, have the system inspected by a professional workshop. Kia recommends to visit an authorized Kia dealer/service partner

Parking in N (Neutral) gear

Follow below steps when parking and you want the vehicle to move when pushed.

1. After parking your vehicle, step on the brake pedal and move the shift lever to P (Park) with the ignition button ON or while the engine is running.
2. If the parking brake is applied unlock the parking brake.

3. While pressing the brake pedal, turn the ignition button OFF. For smart key equipped vehicles, the ignition switch can be moved to OFF only when the shift lever is in P (Park).
4. Change the gear shift lever to N (Neutral) while pressing the brake pedal. Pull the shift lever boot, inserting, pressing down a tool (e.g., flathead screw-driver) into the shift lock release access hole at the same time. Then, the vehicle will move when external force is applied.

⚠ CAUTION

- With the exception of parking in neutral gear, always park the vehicle in P (Park) for safety and engage the parking brake.
- Before parking in N (Neutral) gear, first make sure the parking ground is level and flat. Do not park in N (Neutral) gear on any slopes or gradients. If parked and left in N (Neutral), the vehicle may move and cause serious damage and injury.

Shift dial SBW type



- P (Park)
- R (Reverse)
- N (Neutral)
- D (Drive)

Operation

1. Depress the brake pedal and turn the knob to the desired position.
2. Press P button to shift to P (Park).

Transmission ranges

The indicator in the instrument cluster displays the shift lever position when the ignition switch is in the ON position.



P (Park)

Always come to a complete stop before shifting into P (Park). To shift from P (Park), you must depress firmly on the brake pedal and make sure your foot is off the accelerator pedal. If you have done all of the above and still cannot shift the lever out of P (Park), see "Overriding shift lock" on page 6-14. The shift lever must be in P (Park) before turning the engine off.

N in vehicle ON position



Operation

1. Deactivate AUTO HOLD and release the parking brake.
2. Depress the brake pedal.

3. Turn the shift dial to N (Neutral) and the message will appear on the instrument cluster.
4. Press and hold the OK button on the steering wheel for more than 1 second.
5. Turn the engine off after the message appears on the instrument cluster.

Operating condition(s)

- The vehicle is in ON position.

When the battery is discharged

Operation

1. Connect the battery cables to the jump-starting terminals inside the engine compartment. For more details, refer to "Jump-starting" on page 7-6.
2. Release the parking brake when the vehicle is in ON position.
3. Shift to N (Neutral).

Characteristics of Dual clutch transmission

The dual clutch transmission has seven forward speeds and one reverse speed. The individual speeds are selected automatically when the shift lever is in the D (Drive) position.

- The dual clutch transmission can be thought of as an automatically shifting manual transmission. It gives the driving feel of a manual transmission, yet provides the ease of a fully automatic transmission.
- When D (Drive) is selected, the transmission will automatically shift through the gears similar to a conventional automatic transmission. Unlike a traditional automatic transmission, the gear shifting can sometimes be

felt and heard as the actuators engage the clutches and the gears are selected.

- The dual clutch transmission incorporates a dry-type dual clutch mechanism, which allows for better acceleration performance and increased fuel efficiency while driving. But it differs from a conventional automatic transmission because it does not incorporate a torque converter. Instead, the transition from one gear to the next is managed by clutch slip, especially at lower speeds.

As a result, shifts are sometimes more noticeable, and a light vibration can be felt as the transmission shaft speed is matched with the engine shaft speed. This is a normal condition of the dual clutch transmission.

- The dry-type clutch transfers torque more directly and provides a direct-drive feeling which may feel different from a conventional automatic transmission. This may be more noticeable when launching the vehicle from a stop or when traveling at low, stop-and-go vehicle speeds.
- When rapidly accelerating from a lower vehicle speed, the engine rpm may increase dramatically as a result of clutch slip as the dual clutch transmission selects the correct gear. This is a normal condition.
- When accelerating from a stop on an incline, press the accelerator smoothly and gradually to avoid any shudder feeling or jerkiness.
- When traveling at a lower vehicle speed, if you release the accelerator pedal quickly, you may feel engine braking before the transmission changes gears. This engine braking

feeling is similar to operating a manual transmission at low speed.

- When driving downhill, you may wish to move the gear shift lever to Manual Shift mode and downshift to a lower gear in order to control your speed without using the brake pedal excessively.
- When you turn the engine on and off, you may hear clicking sounds as the system goes through a selftest. This is a normal sound for the dual clutch transmission.
- During the first 1,500 km (1000 miles), you may feel that the vehicle may not be smooth when accelerating at low speed. During this break-in period, the shift quality and performance of your new vehicle is continuously optimized.

LCD display messages

Shift dial SBW type of LCD display messages

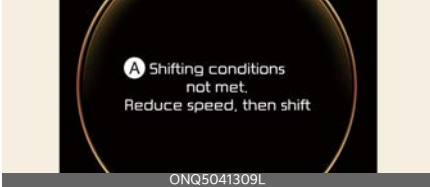
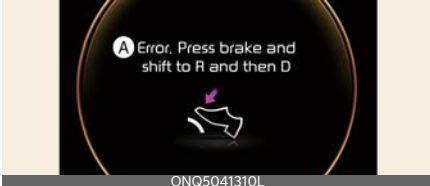
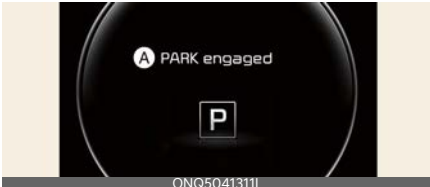
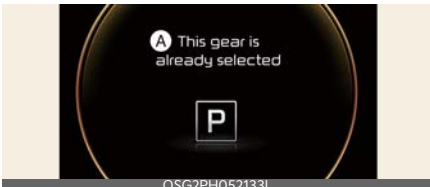
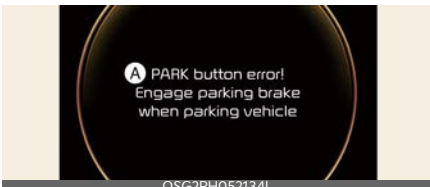

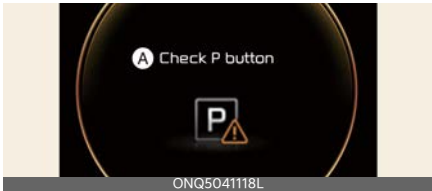
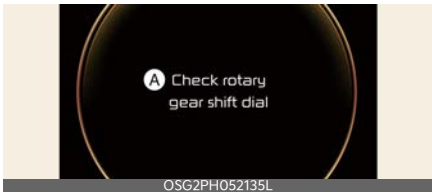
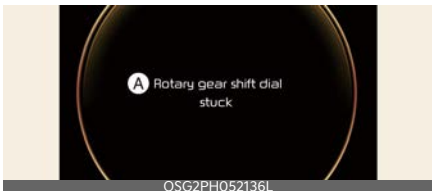
Message	Content
 <p>A Shifting conditions not met. Reduce speed, then shift</p> <p>ONQ5041309L</p>	<p>A: Shifting conditions not met. Reduce speed, then shift</p> <ul style="list-style-type: none"> When driving speed is too fast to shift the gear.
 <p>A Error. Press brake and shift to R and then D</p> <p>ONQ5041310L</p>	<p>A: Error. Press brake and shift to R and then D</p> <ul style="list-style-type: none"> When the brake pedal is not depressed while shifting the gear.
 <p>A PARK engaged</p> <p>ONQ5041311L</p>	<p>A: PARK engaged</p> <ul style="list-style-type: none"> When the gear is shifted to P (Park) while the vehicle is moving.
 <p>A This gear is already selected</p> <p>OSG2PH052133L</p>	<p>A: This gear is already selected</p> <ul style="list-style-type: none"> When P (Park) is selected again or the gear is overheated.
 <p>A PARK button error! Engage parking brake when parking vehicle</p> <p>OSG2PH052134L</p>	<p>A: PARK button error! Engage parking brake when parking vehicle</p> <ul style="list-style-type: none"> When there is a problem with function engaging P (Park) position.

Message	Content
 <p>ONQ5041118L</p>	<p>A: Check P button</p> <ul style="list-style-type: none"> When there is a problem with there is problem with the P (Park) button.
 <p>OSG2PH052135L</p>	<p>A: Check rotary gear shift dial</p> <ul style="list-style-type: none"> When there is problem with the shift dial.
 <p>OSG2PH052136L</p>	<p>A: Rotary gear shift dial stuck</p> <ul style="list-style-type: none"> When the shift dial is continuously stuck or there is problem with the shift dial.

Shift dial SBW type of DCT warning messages

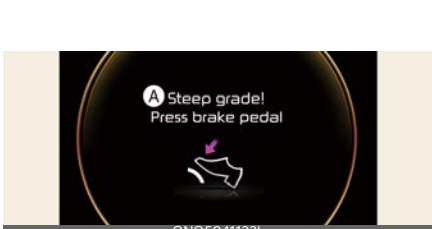
6

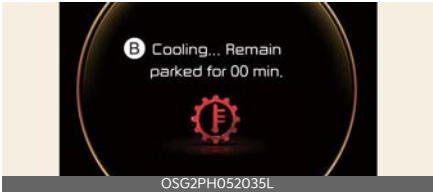
Message	Content
 <p>ONQ5041123L</p>	<p>A: Steep grade! Press brake pedal</p> <ul style="list-style-type: none"> To hold the vehicle on an incline use the foot brake or the parking brake. When in stop-and-go traffic on an incline, allow a gap to form ahead of you before moving the vehicle forward. Then hold the vehicle on the incline with the foot brake. If the vehicle is held on a hill by applying the accelerator pedal or by creeping with brake pedal disengaged, the clutch and transmission may overheat which can result in damage. At this time, a warning message will appear on the LCD display. If the LCD warning is active, the foot brake must be applied. Ignoring the warnings can lead to damage to the transmission.

Message	Content
 <p>OSG2PH052033L</p>	<p>A: Transmission temp. is high! Stop safely</p> <ul style="list-style-type: none"> Under certain conditions, such as repeated stop-and-go launches on steep grades, sudden take off or acceleration, or other harsh driving conditions, the transmission clutch temperatures will increase excessively. Finally the clutch in transmission could be overheated. <p>* NOTICE</p> <ul style="list-style-type: none"> When driving in stop-and-go traffic, in stop condition, to reduce the driving stress and have better transmission operation move the shift lever to N (Neutral) or P (Parking) position. When the clutch is overheated, the safe protection mode engages and the gear position indicator on the cluster blinks with a chime. At this time, "Transmission temp. is high! Stop safely" warning message will appear on the LCD display and driving may not be smooth. If this occurs, pull over to a safe location, stop the vehicle with the engine running, apply the parking brake after shifting the vehicle to N (Neutral) with the brake pedal depressed, and allow the transmission to cool. If you ignore this warning, the driving condition may become worse. You may experience abrupt shifts, frequent shifts, or jerkiness. To return to the normal driving condition, stop the vehicle and apply the foot brake or shift into P (Park). Then allow the transmission to cool for a few minutes with engine on, before driving off. When possible, drive the vehicle smoothly.
 <p>OSG2PH052034L</p>  <p>OSG2PH052035L</p>  <p>OSG2PH052036L</p>	<p>A: Transmission Hot! Park with engine on B: Cooling... Remain parked for 00 min. C: Transmission cooled down. Resume driving</p> <ul style="list-style-type: none"> If the vehicle continues to be driven and the clutch temperatures reach the maximum temperature limit, the "Transmission hot! Park with engine On" warning will be displayed. When this occurs the clutch is disabled until the clutch cools to normal temperatures. The warning will display a time to wait for the transmission to cool. If this occurs, pull over to a safe location, stop the vehicle with the engine running, apply the brakes and shift the vehicle to P (Park), and allow the transmission to cool. When the message "Trans cooled. Resume driving." appears you can continue to drive your vehicle. When possible, drive the vehicle smoothly. <p>If any of the warning messages in the LCD display continue to blink, for your safety, We recommend have the system checked by an authorised Kia dealer/service partner.</p>

⚠ WARNING

To reduce the risk of serious injury or death:

- Always check the surrounding areas near your vehicle for people, especially children, before shifting a vehicle into D (Drive) or R (Reverse).
- Before leaving the driver's seat, always make sure the gear is in the P (Park) position; then set the parking brake, and place the ignition switch in the LOCK/OFF position. Unexpected and sudden vehicle movement can occur if these precautions are not followed.
- Always fully depress the brake pedal before and while shifting out of the P (Park) into another position to avoid inadvertent motion of the vehicle which could injure persons in or around the vehicle.
- After the vehicle has stopped, always make sure the gear is in P (Park), apply the parking brake, and turn the vehicle off.
- Do not use the P (Park) position in place of the parking brake. Always make sure the gear is in P (Park) position and set the parking brake fully.
- Never leave a child unattended in a vehicle.
- Do not drive with the gear in N (Neutral). The engine brake will not work and lead to an accident.
- To avoid damage to your transmission, do not try to accelerate with the shift lever in R (Reverse) or any forward gear position with the brake engaged.
- Do not use the engine brake (shifting from a high gear to lower gear) rapidly on slippery roads. The vehicle may slip causing an accident.
- Shifting into P (Park) while the vehicle is in motion will cause the drive wheels to lock which will cause you to lose control of the vehicle.
- When parking on an incline, block the wheels to prevent the vehicle from rolling down.
- For safety, always engage the parking brake with the gear in the P (Park) position except for the case of emergency parking.
- **DCT failure**
 - Do not use aggressive engine braking (shifting from a higher gear to a lower gear) on slippery roads. This could cause the tires to slip and may result in an accident.
 - Do not shift into gear unless your foot is firmly on the brake pedal. Shifting into gear when the engine is running at high speed can cause the vehicle to move very rapidly. You could lose control of the vehicle and hit people or objects.
 - When stopped on a slope, do not hold the vehicle with accelerator pedal. Engage the service brake or the parking brake.
 - If the transmission cannot shift into D (Drive) or R (Reverse), the position indicator (D or R) on the cluster will blink. We recommend that you contact an authorized Kia dealer/service partner to have the system checked.

⚠ CAUTION

- Always come to a complete stop before shifting into or out of R (Reverse); you may damage the

transmission if you shift into R (Reverse) while the vehicle is in motion, except as explained in "Rocking the vehicle" on page 6-174.

- Always park the vehicle in P (Park) for safety and engage the parking brake. If left in N (Neutral), the vehicle may move and cause serious damage and injury.
- After the vehicle has been turned off, the electronic parking brake cannot be disengaged.
- For EPB (Electronic Parking Brake) equipped vehicles with AUTO HOLD function used while driving, if the vehicle is in OFF position, the electronic parking brake will be engaged automatically. Therefore, AUTO HOLD function should be turned off before the vehicle is in OFF position.
- Do not shift from N (Neutral) or P (Park) into D (Drive), or R (Reverse) when the engine is above idle speed. The transmission may be damaged if you shift into P (Park) while the vehicle is in motion.

* NOTICE

Manual mode

• For shift lever type

- The driver must execute upshifts in accordance with road conditions, taking care to keep the engine speed below the red zone.
- Downshifts are made automatically when the vehicle slows down. When the vehicle stops, 1st gear is automatically selected.
- When the engine rpm approaches the red zone shift points are varied to upshift automatically.

- To maintain the required levels of vehicle performance and safety, the system may not execute certain gearshifts when the gear is operated.
- When driving on a slippery road, shift into the 2nd gear which is better for smooth driving on a slippery road.
- Always come to a complete stop before shifting into D (Drive) or R (Reverse).
- Do not put the shift lever in N (Neutral) while driving.
- The driver must execute upshifts in accordance with road conditions, taking care to keep the engine speed below the red zone.
- Only the 6 or 7 forward gears can be selected. To reverse or park the vehicle, move the gear to the R (Reverse) or P (Park) position as required.
- Downshifts are made automatically when the vehicle slows down. When the vehicle stops, 1st gear is automatically selected.
- The fuel efficiency may decrease.
- If the driver presses the lever to + (Up) or - (Down) position, the transmission may not make the requested gear change if the next gear is outside of the allowable engine rpm range.

• For DCT type

- When manual mode is activated: The engine rpm will tend to remain raised over a certain length of time even after releasing the accelerator. Upshifts are delayed when accelerating.

Paddle shifter

Manual mode

Paddle shifter is used to shift without taking your hands off the steering wheel.



Operation

- Pull the right side (+) of the paddle shifter once to shift up.
- Pull the left side (-) of the paddle shifter once to shift down.

Operating condition(s)

- The shift lever is in manual mode. (if equipped)
- The vehicle is in D (Drive) and SPORT mode.

CAUTION

- If you pull the left and right side of the paddle shifters at the same time, you cannot shift the gear.
- Sudden engine brakes and rapid acceleration could cause malfunction. Shift appropriately according to road conditions and driving speed.

* NOTICE

- The vehicle will shift to manual to automatic shift mode in following conditions:
 - When the vehicle speed decreases below 3 km/h (2 mph).
 - When the accelerator pedal is gently depressed for more than 6 seconds while driving.

Regenerative braking mode



Operation

- Pull the left side (-) of the paddle shifter to increase regenerative braking and deceleration. Pull and hold the left side (-) of the paddle shifter to reach MAX and stop the vehicle.
- Pull the right side (+) of the paddle shifter to decrease regenerative braking and deceleration.

Pull and hold the right side (+) of the paddle shifter to turn on or off smart regeneration system.

⚠ CAUTION

- The initial setting will be set to 0 when the vehicle is in D (Drive) and in ECO mode.
- If the vehicle changes to P (Park), R (Reverse), N (Neutral) or manual mode (shift lever), or vehicle is in SPORT mode, the vehicle regenerative braking system control will not be operated. Resetting the vehicle in D (Drive) will set the regenerative system setting to 0.
- ABS and ESC will deactivate the regenerative system.
- Even if the setting for regenerative braking system is identical, it might feel different due to various vehicle speeds. (the higher speed, the less deceleration feeling)
- The regenerative braking system can be controlled
 - when the vehicle is stop in D (Drive)
 - when you are not depressing brake pedal, and the vehicle is above 2 km/h (1 mph)

*** NOTICE**

Regenerative braking uses motor's power to conserve energy to the high-voltage battery when braking to gain more fuel economy and higher efficiency.

Battery charged, Regenerative braking mode deactivated



A: Regenerative braking not available. Battery fully charged.

The message will appear when the high-voltage battery amount is charged enough.

Regenerative braking mode by paddle shifter not activated

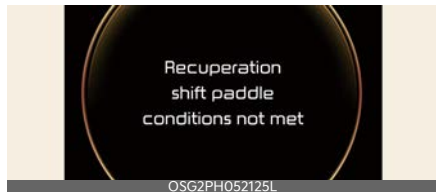

A: Recuperation shift paddle conditions not met.

The message will appear when:

- When the battery is in high or low temperature
- When the battery or transmission is not functioning properly
- Regenerative braking mode is activated while ABS/Cruise Control/Smart Cruise Control is operating

Drive normally and use the function again to dismiss the message.

Vehicle stop function (MAX setting)

Operation

- Pull and hold the left side (-) of the paddle shifter to stop the vehicle.
- The instrument cluster indicator will set to MAX when the vehicle is braking.
- The instrument cluster indicator will set to STOP when the vehicle is stopped.
- The left side (-) of the paddle shifter should be pulled while driving.
- If the vehicle is stopped, the vehicle will retain its position when the left side (-) of the paddle shifter is not pulled.
- Depress the accelerator pedal to move the vehicle in STOP position.
- Depressing the brake pedal in MAX position will retain its settings regardless of paddle shifter operation. (The vehicle will set to STOP position when the vehicle is stopped.)

⚠ CAUTION

- The function does not control the distance between vehicles.
- The vehicle may not stop properly on steep hills. Depress the brake to stop the vehicle.

Smart regeneration system

The Smart Regeneration System controls the regenerative braking automatically according to the road gradient and driving condition of the vehicle in front.

The system minimizes the unnecessary operation of the brake and acceleration pedal, improving the electric efficiency and assisting the driver.

Setting smart regeneration system

Operation

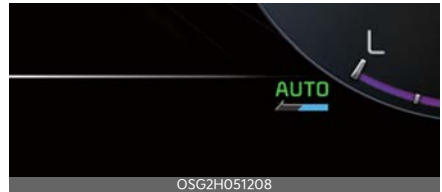

- With the vehicle on, touch **Settings** → **Vehicle** → **Eco Vehicle** → **Smart Recuperation** on the infotainment system or pull and hold the right side paddle shifter for over 1 second to turn on and off the automatic change of the regenerative braking.

The level of regenerative braking displayed on the cluster in stages is converted to the 'AUTO' indicator light.

- When the vehicle is turned off and then turned on again, the regenerative braking mode returns to step '0'.

* INFORMATION

The infotainment system may change after software updates. For more information, refer to the manual provided in the infotainment system and the quick reference guide.

Smart regeneration system activation

With 'AUTO' for the regenerative braking level displayed on the cluster, the regenerative braking level is controlled automatically when vehicle speed is above 12 km/h (7.4 mph) and one of the condition below is met.

- The road gradient changes
- Distance from the vehicle ahead reduces or increases
- Speed of the vehicle ahead reduces or increases

* NOTICE

When vehicle speed is under 12 km/h (7.4 mph), the Smart Regeneration System is canceled. The driver must adjust the vehicle speed by depressing the accelerator or brake pedal according to the road condition ahead and driving condition.

When the system is turned on from the Vehicle Settings menu, but the front radar does not recognize the vehicle in front, 'AUTO' is displayed in white.

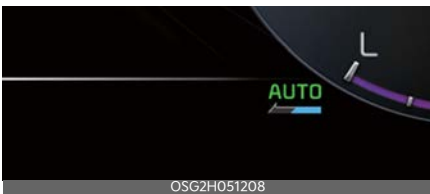

If the front radar recognizes the vehicle in front, 'AUTO' is displayed in green. The regenerative braking level is automatically controlled depending on the driving condition of the vehicle in front and the level is indicated with arrows.

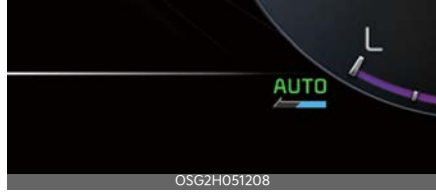

However, current regenerative braking level is maintained if the driver depresses the brake pedal while the system is in activation. Also, the system is canceled temporarily if the accelerator pedal is depressed.

⚠ WARNING

The Smart Regeneration System which automatically controls the regenerative braking level when coasting is only a supplemental system for the driver's convenience. Do not solely rely on this system to stop the vehicle. **The system cannot completely stop the vehicle in all situations nor avoid all collisions.**

The brake control may be insufficient depending on the speed of the vehicle in front and when the vehicle in front suddenly stops, a vehicle cuts in suddenly or there is a steep slope. Always look ahead cautiously to prevent unexpected and sudden situations from occurring.

Smart regeneration system will be temporarily canceled when:

- Canceled manually
 With the vehicle on, touch **Settings** → **Vehicle** → **Eco Vehicle** → **Smart Recuperation** on the infotainment system or pull and hold the right side paddle shifter for over 1 second.
 The Smart Regeneration System turns off and switches to the regenerative braking level indicator with arrows instead of 'AUTO' indicator.

- Canceled automatically
 - The vehicle is shifted to N (Neutral), R (Reverse) or P (Park) or shift lever in manual mode.
 - Switch the DRIVE mode to SPORT mode.
 - Smart Cruise Control is in activation.
 - The ESC (Electronic Stability Control) or ABS is operating.
 - If the motor and battery are in high or low temperature, or there is a problem with the battery or transmission.
 - SOC (State of Charge) gauge indicates high level.

⚠ WARNING

When the Smart Regeneration System is canceled automatically, adjust the vehicle speed directly by depressing the accelerator or brake pedal according to the road and driving conditions ahead.

* INFORMATION

The infotainment system may change after software updates. For more information, refer to the manual provided in the infotainment system and the quick reference guide.

Resuming smart regeneration system

To re-activate the Smart Regeneration System while driving, with the vehicle on, touch **Settings** → **Vehicle** → **Eco Vehicle** → **Smart Recuperation** on the infotainment system or pull and hold the right side paddle shifter for over 1 second.

Then AUTO for the regenerative braking level will appear on the cluster.

* INFORMATION

The infotainment system may change after software updates. For more information, refer to the manual provided in the infotainment system and the quick reference guide.

Basic setting of smart regeneration system

With the Smart Regeneration System ON, Pull and hold the right side of the paddle shifter for more than 1 second to set the regenerative braking level.

The automatic regenerative braking step adjustment by the smart regenerative system operates in steps beyond the set basic step.

Vehicle-to-vehicle distance recognition sensor

In order for the Smart Regeneration System to operate properly, always make sure the radar sensor cover is clean and free of dirt, snow, and debris.

Dirt, snow, or foreign substances on the lens may adversely affect the sensing performance of the sensor. In this case, the system operation may stop temporarily and not operate normally.

Front radar



⚠ CAUTION

- Do not apply license plate frame or foreign objects such as a bumper sticker or a bumper guard near the radar sensor. Doing so may adversely

affect the sensing performance of the radar.

- Always keep the radar sensor and lens cover clean and free of dirt and debris.
- Use only a soft cloth to wash the vehicle. Do not spray pressurized water directly on the sensor or sensor cover.
- Be careful not to apply unnecessary force on the radar sensor or sensor cover. If the sensor is forcibly moved out of proper alignment, the Smart Regeneration System may not operate correctly. In this case, a warning message may not be displayed. Have the vehicle inspected by an authorized Kia dealer/service partner.
- If the front bumper becomes damaged in the area around the radar sensor, the Smart Regeneration System may not operate properly. Have the vehicle inspected by an authorized Kia dealer/service partner.
- Use only Kia Genuine Parts or those of an equivalent standard to repair or replace a damaged sensor or sensor cover. Do not apply paint to the sensor cover.

System malfunction

The following message will appear when the Smart Regeneration System is not functioning normally.

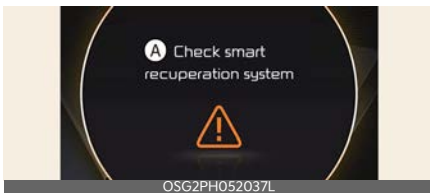

A: Check smart regeneration system

The message will appear when the system is not functioning normally. The sys-

tem will be canceled and the word 'AUTO' on the cluster will disappear and instead display regenerative braking level. Check for foreign substances on the front radar. Remove any dirt, snow, or foreign material that could interfere with the radar sensors. If the system still does not operate normally, take your vehicle to an authorized Kia dealer and have the system checked.

Limitations of the system

The Smart Regeneration System may not operate properly in certain situations when the driving condition is beyond the performance of the front radar sensor. Driver's attention is required in such cases when the system does not react properly or operate unintentionally.

Driving on a curved road



When driving on the curve, the system may not detect the vehicle in your lane and the regenerative braking level will reduce automatically, making you feel that the vehicle is accelerating.

Also, if the system suddenly recognizes the vehicle in front, the regenerative braking level will increase automatically, making you feel that the vehicle is decelerating.

The driver must maintain a safe braking distance, and if necessary, depress the brake pedal to reduce your driving speed in order to maintain a safe distance.



OSG2H051210

The smart regeneration system may recognize a vehicle in an adjacent lane when driving on a curved road. In this case, the system increase the braking level and slow the vehicle.

Always pay attention to road and driving conditions while driving. If necessary, depress the brake pedal to reduce your driving speed in order to maintain a safe distance. Also, when necessary, you may depress the accelerator pedal to prevent the system from unnecessarily decelerating your vehicle.

Always check the traffic conditions around the vehicle.

Driving on a sloped road



OSG2H051211

When driving uphill or downhill, the system may not detect the vehicle in your lane and the regenerative braking level will reduce automatically, making you feel that the vehicle is accelerating.

Also, if the system suddenly recognizes the vehicle in front, the regenerative braking level will increase automatically, making you feel that the vehicle is decelerating.

The driver must maintain a safe braking distance, and if necessary, depress the

brake pedal to reduce your driving speed in order to maintain a safe distance.

Changing lanes

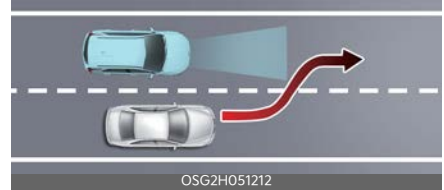

OSG2H051212

When a vehicle changes lanes in front of you, the smart regeneration system may not immediately detect the vehicle, especially if the vehicle changes lanes abruptly. In this case, you must maintain a safe braking distance, and if necessary, depress the brake pedal to reduce your driving speed in order to maintain a safe distance.

Recognizing the vehicle



OSG2H051061

Some vehicles in your lane cannot be recognized by the sensor:

- Narrow vehicles such as motorcycles or bicycles
- Vehicles offset to one side
- Slow-moving vehicles or sudden-decelerating vehicles
- Stopped vehicles (When the vehicle ahead drives away, the system may not detect a stopped vehicle.)
- Vehicles with small rear profile such as trailers with no loads

A vehicle ahead cannot be recognized correctly by the sensor if any of the following occurs:

- When the vehicle is pointing upwards due to overloading in the luggage compartment
- While the steering wheel is operating
- When driving to one side of the lane
- When driving on narrow lanes or on curves

Apply the brake or accelerator pedal if necessary.

WARNING

When using the Smart Regeneration System take the following precautions:

- If an emergency stop is necessary, you must apply the brakes.
- Keep a safe distance according to road conditions and vehicle speed. If the vehicle distance is too close during high-speed driving, a serious collision may result.
- Always maintain sufficient braking distance and decelerate your vehicle by applying the brakes if necessary.
- The Smart Regeneration System is designed to detect and monitor the vehicle ahead in the roadway through radar signals. It is not designed to detect oncoming vehicles, pedestrians, bicycles, motorcycles, or smaller wheeled objects such as luggage bags, shopping carts, or strollers.
- Vehicles moving in front of you with a frequent lane change may cause a delay in the system's reaction or may cause the system to react to a vehicle actually in an adjacent lane. Always drive cautiously to prevent unexpected and sudden situations from occurring.

- The Smart Regeneration System may not recognize complex driving situations so always pay attention to driving conditions and control your vehicle speed.

NOTICE

The Smart Regeneration System may not operate temporarily due to:

- Electrical interference
- Modifying the suspension
- Differences of tire abrasion or tire pressure
- Installing different type of tires

Brake system

In the event of brake failure

Operation

- Make an emergency stop with the parking brake.

Operating condition(s)

- The brake has failed

⚠ WARNING

Avoid applying the parking brake to stop the vehicle while it is moving except in an emergency situation. Applying the parking brake while the vehicle is moving at normal speeds can cause a sudden loss of control of the vehicle. If you must use the parking brake to stop the vehicle, use great caution in applying the brake.

Power-assisted brakes

Operation

- Apply greater force to the brake pedal.

Operating condition(s)

- The vehicle is stalled

⚠ WARNING

Avoid continuous application of the brakes when descending a long or steep hill by shifting to a lower gear. Continuous brake application will cause the brakes to overheat and could result in a temporary loss of braking performance.

⚠ CAUTION

Do not drive with your foot resting on the brake pedal. This will create abnormally high brake temperatures which can cause excessive brake lining and pad wear.

*** NOTICE**

- When stepping on the brake pedal under a certain driving or weather condition, you may witness your car make a sound of squealing or some other noises. This is not a brake malfunction but a normal phenomenon.
- When driving on the road to which deicing chemicals are applied, the vehicle may witness noises from the brake or abnormal abrasion of tires because of such deicing chemicals. You should operate brake additionally so that you would be able to remove the deicing chemicals on the brake disk and pad under a safe traffic condition.

Brake over accelerator

Operation

1. Apply the brakes steady and firmly.
2. Stop the vehicle safely.
3. Shift to P. Turn the engine off and apply the parking brake.
4. Inspect the accelerator pedal for any interference.

Operating condition(s)

- The accelerator pedal is stuck

*** NOTICE**

If none are found and the condition persists, have your vehicle towed to a pro-

professional workshop and inspected. Kia recommends to visit an authorized Kia dealer/service partner.

Disc brake wear indicator

The front or rear brakes will squeal when the brake pads are worn. Always replace the front or rear brake pads as pairs.

⚠️ WARNING

Do not ignore high pitched wear sounds from your brakes. If you ignore this audible warning, you will eventually lose braking performance, which could lead to a serious accident.

⚠️ CAUTION

Do not continue to drive with worn brake pads. Continuing to drive with worn brake pads can damage the braking system and result in costly brake repairs.

* NOTICE

Brake dust may accumulate on the wheels, even under normal driving conditions. Some dust is inevitable as the brakes wear and contribute to brake noise.

Parking brake

Check if the brake warning light (ⓘ) appears when the vehicle is in the START or ON position. Be sure the parking brake is fully released and the brake warning light (ⓘ) is off before driving.

Electronic Parking Brake (EPB)

Applying EPB manually



Operation

- Depress the brake pedal and pull the EPB switch up to apply the parking brake.
- Depress the brake pedal. Make sure the gear is in P and push the EPB switch down to release the parking brake.

⚠️ WARNING

- Risk of accident and injury due to children left unattended in the vehicle. If you leave children unaccompanied in the vehicle, they may be able to set the vehicle in motion, for example by:
 - Releasing the parking brake.
 - Shifting the transmission out of P (Park) position.
 - Starting the engine. In addition, they may operate vehicle equipment.
- Never leave children and animals unattended in the vehicle.
- When leaving the vehicle, always take the smart key with you and lock the vehicle.

* NOTICE

- On a steep incline or when pulling a trailer, if the vehicle does not remain at a standstill, do as follows:
 - Apply the EPB.

- Pull up the EPB switch for more than 3 seconds.
- A click or electric brake motor whine sound may be heard while operating or releasing the EPB. These conditions are normal and indicate that the EPB is functioning properly.

Applying EPB automatically

Operating condition(s)

- Shifting to P on a slope for shift dial SBW type
- Vehicle is in OFF position while AUTO HOLD is enabled
- When the vehicle moves a bit in P for shift dial SBW type
- Requested by other systems
- Conditions below while AUTO HOLD is activated:
 - Driver's door is opened
 - Hood is opened
 - Tailgate is opened
 - Vehicle stops for more than approximately 10 minutes
 - Vehicle stops on a steep slope
 - Requested by other systems

* NOTICE

For Electronic Parking Brake (EPB) equipped vehicles with AUTO HOLD function used while driving, if the ENGINE START/STOP button has been turned OFF, the EPB will be engaged automatically. Therefore, AUTO HOLD function should be turned off before the ENGINE START/STOP button is turned off.

Releasing EPB automatically

Operation

- The EPB is released automatically under following conditions when you shift the gear.
 1. With the engine running depress the brake pedal and shift out of P (Park) or N (Neutral) to R (Reverse) or D (Drive).
- The EPB is released automatically under following conditions when you start driving,
 1. Ensure seat belts are fastened and the doors, hood and tailgate are closed.
 2. With the engine running, depress the brake pedal and shift out of P (Park) to R (Reverse), D (Drive) or Manual shift mode.
 3. Depress the accelerator pedal.
 4. Make sure the Parking Brake warning light goes off.

⚠ CAUTION

Do not drive your vehicle with the EPB applied. It may cause excessive brake pad and brake rotor wear.

* NOTICE

- For the Middle East, EPB is released regardless of seat belt fastening.
- Do not follow these procedures when driving on a flat level ground. The vehicle may suddenly move forward:
 - For your safety, depress the brake pedal and release the parking brake manually with the EPB switch when you drive downhill or when backing up the vehicle.
 - For your safety, you can engage the EPB even though the vehicle is

in the OFF position, but you cannot release it.

- If the parking brake warning light is still on even though the EPB has been released, have the system checked by a professional workshop. Kia recommends to visit an authorized Kia dealer/service partner.

EPB warning message

Operating condition(s)

- Attempting to drive off while engaging the accelerator pedal with the EPB applied
- Driver's seat belt is not fastened and the vehicle hood, driver's door or tailgate is opened
- There is a problem with the vehicle
- Conversion from AUTO HOLD to EPB is not working properly
- EPB is applied while AUTO HOLD is activated due to Electronic Stability Control (ESC) signal

EPB malfunction indicator



If the EPB malfunction indicator remains on, appears while driving, or does not appear when the vehicle is in the ON position, this indicates the EPB may malfunction.

Have your vehicle checked by a professional workshop as soon as possible. Kia recommends to visit an authorized Kia dealer/service partner.

* NOTICE

- The EPB warning light may appear if the EPB switch operates abnormally. Shut the engine off and turn it on again after a few minutes. The warning light will go off and the EPB switch will operate normally. However, if the EPB warning light is still on, have the system checked by a professional workshop. Kia recommends to visit an authorized Kia dealer/ service partner.
- If the parking brake warning light does not appear or blinks even though the EPB switch was pulled up, the EPB is not applied.
- If the parking brake warning light blinks when the EPB warning light is on, press the EPB switch, then pull it up. Once more press it back to its original position and pull it back up. If the EPB warning does not go off, have the system checked by a professional workshop. Kia recommends to visit an authorized Kia dealer/service partner.

Emergency braking with the EPB switch

Pull and hold the EPB switch up to engage the emergency brake.

⚠ WARNING

Do not operate the Electronic Parking Brake (EPB) while the vehicle is moving except in an emergency situation. Applying the EPB while the vehicle is moving at normal speeds can cause a sudden loss of control of the vehicle. If you must use the EPB to stop the vehicle, use great caution in applying the brake.

* NOTICE

During emergency braking by the EPB, the parking brake warning light will appear to indicate that the system is operating.

When the EPB does not release properly

Load the vehicle on a flatbed tow truck and take your vehicle to a professional workshop to check the system. Kia recommends to visit an authorized Kia dealer/service partner.

Brake Disc Cleaning (BDC)

If there is a surface rust on the brake disc or squeal can be heard, use Brake Disc Cleaning function to reduce noise and rust. While using Brake Disc Cleaning function, the regenerative brake system will be temporarily deactivated and the fuel economy may be reduced.

Operation

- Press AUTO HOLD button for more than 3 seconds.
 - If the message is shown on the cluster, Brake Disc Cleaning function is activated.
 - Depress the brake pedal around 10 times and the regenerative braking will be temporarily deactivated. The rust and noise will be reduced. Brake Disc Cleaning operation time can change per braking conditions.
 - Brake Disc Cleaning function will be automatically deactivated after operation. To manually turn off, turn the vehicle to OFF position or press AUTO HOLD button for more than 3 seconds

AUTO HOLD

The AUTO HOLD maintains the vehicle in a stopped position without depressing the brake pedal.

Applying AUTO HOLD

Operation

1. Press the AUTO HOLD button. The AUTO HOLD indicator will appear white.
2. The AUTO HOLD indicator changes from white to green when the vehicle is stopped.

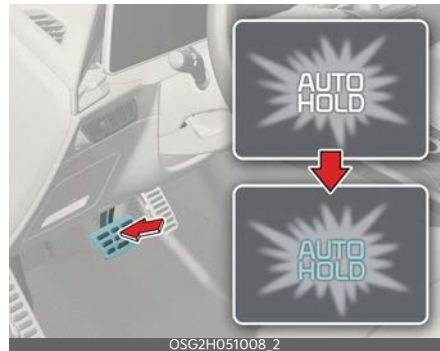

3. AUTO HOLD will be released automatically when the accelerator pedal is depressed in D, R or in the manual mode. the AUTO HOLD indicator changes from green to white.
4. Press the AUTO HOLD button again while depressing the brake pedal to cancel the AUTO HOLD operation.



Non-operating condition(s)

- The gear is in P (Park)
- The EPB is applied

* INFORMATION

If the vehicle is restarted with the AUTO HOLD button pressed, AUTO HOLD will be in the standby state.

⚠ WARNING

- To reduce the risk of an accident, do not activate AUTO HOLD while driving downhill, backing up or parking your vehicle.
- For shift lever type, AUTO HOLD will not be activated when the gear is in R (Reverse).

* NOTICE

- If the AUTO HOLD indicator lights up yellow, the AUTO HOLD is not working properly. Take your vehicle to a professional workshop and have the system checked. Kia recommends to visit an authorized Kia dealer/service partner.
- A click or electric brake motor whine sound may be heard while operating or releasing the EPB, but these conditions are normal and indicate that the EPB is functioning properly.
- The AUTO HOLD indicator does not change from white to green when the vehicle is stopped by regenerative braking mode.

AUTO HOLD warning messages

The AUTO HOLD function will display a warning message with sound under certain conditions:

- When the EPB is automatically applied from AUTO HOLD
- AUTO HOLD to EPB conversion is not working properly
- Brake pedal is not applied when the AUTO HOLD button is pressed

Vehicle safety system

Anti-lock Brake System (ABS)

The Anti-lock Brake System (ABS) prevents the wheels from locking to steer and stabilize the vehicle.

If the ABS warning light (ABS) stays on, contact a professional workshop as soon as possible. Kia recommends to visit an authorized Kia dealer/service partner.

* NOTICE

- A click sound may be heard in the vehicle compartment when the vehicle begins to move after the vehicle is started. These conditions are normal and indicate that the Anti-lock Brake System is functioning properly.
- When you jump start your vehicle because of a drained battery, the vehicle may not run as smoothly and the ABS warning light may turn on at the same time. This happens because of low battery voltage. It does not mean your ABS has malfunctioned.
 - Do not pump your brakes!
 - Have the battery recharged before driving the vehicle.

Electronic Stability Control (ESC)

Electronic Stability Control (ESC) is designed to stabilize the vehicle during cornering maneuvers.

ESC is not a substitute for safe driving practices. Factors including speed, road conditions and driver steering input can all affect whether ESC will be effective in preventing a loss of control.

Operating ESC OFF button



Operation

1. Press the ESC OFF button for approximately half a second to turn ESC off. ESC OFF (ESC OFF) indicator light will appear and the warning chime will sound.
2. Press and hold the ESC OFF button again for approximately 3 second to turn ESC and traction control off. ESC OFF (ESC OFF) indicator light will appear and the warning chime will sound.
3. To turn ESC on again, press the ESC OFF button. ESC OFF (ESC OFF) indicator light will go off.

⚠ WARNING

- For maximum protection, always wear your seat belt. No system, no matter how advanced, can compensate for all driver error and/or driving conditions. Always drive responsibly.
- Drive carefully even though your vehicle has Electronic Stability Control. It can only assist you in maintaining control under certain circumstances.
- Never press the ESC OFF button while ESC is operating (ESC indicator light blinks). If ESC is turned off while ESC is operating, the vehicle may slip out of control.

* NOTICE

- A click sound may be heard in the vehicle compartment when the vehicle begins to move after the vehicle is

started. These conditions are normal and indicate that the Electronic Stability Control system is functioning properly.

- When operating the vehicle on a dynamometer, ensure that the ESC is turned off (ESC OFF light appeared). If the ESC is left on, it may prevent the vehicle speed from increasing, and result in false diagnosis.
- Turning the ESC off does not affect ABS or brake system operation.

Hill-start Assist Control (HAC)

Hill-start Assist Control (HAC) prevents the vehicle from rolling back by applying the brakes automatically for approximately 2 seconds.

The brakes are released when the accelerator pedal is engaged or after approximately 2 seconds.

WARNING

HAC does not replace the need to apply brakes while stopped on an incline.

While stopped, make sure you maintain brake pressure sufficient to prevent your vehicle from rolling backward and causing an accident. Don't release the brake pedal until you are ready to accelerate forward.

Multi-Collision Brake (MCB) (if equipped)

Multi-Collision Brake controls the brake automatically in the event of an accident where the air bag deploys to reduce the risk of additional accidents that may occur.

System operation

- From the time the air bag deploys, Multi-Collision Brake monitors the depression intensity of the brake pedal and accelerator pedal for a short period. The system operates when the following conditions are met:
 - Vehicle speed is under 180 km/h (112 mph) at the time of collision.
 - The brake pedal and accelerator pedal are hardly depressed.
- When the driver steps on the brake pedal over a certain level while Multi-Collision Brake is active, the braking power takes priority over automatic braking by Multi-Collision Brake system. However, if the driver takes his/her foot off the brake pedal, Multi-Collision Brake system will maintain automatic braking.

System off

- Multi-Collision Brake is canceled in the following situations:
 - The accelerator pedal is depressed over a certain level.
 - The vehicle stops.
 - ESC (Electronic Stability Control) or electronic devices has malfunctioned.
 - In a situation system cannot operate normally.
 - Ten seconds have passed since the brake has been controlled automatically by Multi-Collision Brake system.

⚠ WARNING

- Multi-Collision Brake decreases vehicle speed after a collision and reduces the risk of a second collision, but it does not prevent a second collision. You may drive away from the collision spot to avoid other dangerous situations by depressing the accelerator pedal.
- After the vehicle is stopped by Multi Collision Brake, the system stops controlling the brakes.
Depending on the situation, the driver should depress the brake or the accelerator pedal to prevent further accidents.

Vehicle Stability Management (VSM)

Vehicle Stability Management (VSM) provides further enhancements to vehicle stability and steering responses.

Operating VSM**Operation**

- Press the ESC OFF button to turn VSM off and the ESC OFF indicator light (ESC OFF) is appeared.
- Press the ESC OFF button again to turn VSM on and the ESC OFF indicator light (ESC OFF) will go off.

Operating condition(s)

- Driving on a slippery road
- Friction change of left and right wheels is detected

Non-operating condition(s)

- Driving on a gradient or inclined surface

- Driving in reverse
- ESC OFF indicator light (ESC OFF) remains appeared
- MDPS warning light (MDPS) remains appeared

⚠ WARNING

- When replacing tires and wheels, make sure they are the same size as the original tires and wheels installed. Driving with varying tire or wheel sizes may diminish any supplemental safety benefits of the VSM system.
- **Vehicle Stability Management**
Drive carefully even though your vehicle has Vehicle Stability Management. It can only assist you in maintaining control of the vehicle under certain circumstances.

VSM malfunction indicator

VSM can be deactivated when the malfunction has been detected in the Electronic Power Steering system or VSM system. If the ESC indicator light (ESC OFF) or MDPS warning light (MDPS) remains on, take your vehicle to a professional workshop and have the system checked. Kia recommends to visit an authorized Kia dealer/service partner.

Emergency Stop Signal (ESS) (if equipped)

Emergency Stop Signal (ESS) alerts the driver behind by blinking the brake lights while braking sharply and severely.

Operating condition(s)

- The vehicle suddenly stops.
- ABS is activated and the driving speed is over 55 km/h (34 mph).

- The hazard warning flasher automatically turns ON after blinking the brake lights when:
 - The driving speed is under 40 km/h (25 mph)
 - The ABS is deactivated
 - The sudden braking is over
- The hazard warning flasher turns OFF when:
 - The vehicle drives at a low speed for a certain period of time.

* NOTICE

The Emergency Stop Signal (ESS) system will not activate, when the hazard warning flashers are already on.

Brake Assistant System (BAS)

The Brake Assistant System provides additional pressure when the brake pedal is momentarily and strongly depressed in a situation sudden braking is required while driving.

The Brake Assistant System reduces the time for ABS(Anti-Lock Brake System) control to enter and consequently reduces the braking distance, by providing additional pressure up to the point of ABS intervention.

BAS operation

- When the vehicle speed is more than 30 km/h and the ABS control is not entered.
- When the brake pedal is depressed slightly under a certain level.
- When the friction of the road surface is above a certain level.

BAS operation off

- The vehicle speed is below 10 km/h.
- The brake pedal is depressed over a certain conditions.
- The friction of the road surface is below a certain level.

⚠ WARNING

The system may not operate depending on driver's driving habit, the degree to which the brake pedal is depressed and the road surface condition.

* NOTICE

- The sensing range and objects detectable by the sensors are limited. Pay attention to the road conditions at all times.
- NEVER drive too fast in accordance with the road conditions or while cornering.
- Always drive cautiously to prevent unexpected and sudden situations from occurring. BAS does not stop the vehicle completely and does not avoid collisions.

Drive mode integrated control system

DRIVE MODE

Selecting DRIVE MODE



Operation

- Turn the DRIVE MODE knob.

Mode	Characteristics	SCC Responsiveness
ECO	Improves fuel efficiency for eco-friendly driving	Normal
SPORT	Provides sporty and fun riding	Fast

* INFORMATION

- ECO mode will be maintained when the vehicle is restarted.
- SPORT MODE will change to ECO mode when the vehicle is restarted.

* NOTICE

If there is a problem with the instrument cluster, the drive mode will not be changed and the drive mode will not be displayed normally.

ECO mode

- The engine and transmission control logic are changed to maximize fuel efficiency.
- The ECO indicator will appear.
- Whenever the vehicle is restarted, the drive mode remains in ECO mode.

* NOTICE

Fuel efficiency depends on the driver's driving habit and road condition.

SPORT mode

- The steering effort, the engine and transmission control logic is automatically adjusted for enhanced driver performance.
- The SPORT indicator will appear.
- Whenever the vehicle is restarted, the drive mode sets to ECO mode.
- The engine rpm will tend to remain raised over a certain length of time even after releasing the accelerator.
- Upshifts are delayed when accelerating.

* NOTICE

The fuel efficiency may decrease in SPORT mode.

Active air flap



Active air flap system controls the air flap below the front bumper to cool the vehicle parts and improve energy efficiency.

Active air flap malfunction

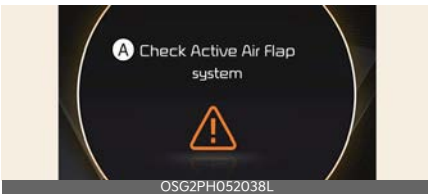

A: Check Active Air Flap System

The active air flap system may not operate normally if the air flap is temporarily opened due to foreign factors or if the controller is contaminated by snow or rain, etc.

When the message is popped up on the display, stop the vehicle in a safe place and check the status of the air flap.

Start the vehicle after performing the necessary work like foreign matter removal and waiting 10 minutes. If the pop-up remains up, have the vehicle inspected by a professional workshop. Kia recommends visiting an authorized Kia dealer/service partner.

⚠ CAUTION

- Regardless of the pop-up, if the air flaps aren't in the same position, stop the vehicle and wait for 10 minutes and start the vehicle and inspect the air flap.
- The active air flap system is actuated by motors. Do not disturb actuation or apply force excessively. It may cause failure.

* NOTICE

Active air flap system could be activate regardless of the vehicle condition.(Parking, driving, charging, etc.)

Green Zone Drive Mode for Europe

In order to protect the atmospheric environment in urban areas, EV mode is expanded when entering the road inside the green zone based on the navigation information.

Also, EV mode is expanded based on the driving history when departing from home.

Geo-fencing feature expands EV mode in the European-wide (Ultra) Low emission zone. (For Europe/Plug-in hybrid vehicle only)

Operation

With the vehicle on, touch **Settings** → **Eco Vehicle** → **Green Zone EV Drive** on the instrument cluster, or touch **Settings** → **Vehicle** → **Eco Vehicle** → **Green Zone EV Drive** on the infotainment system.

Green Zone Drive Mode LCD display

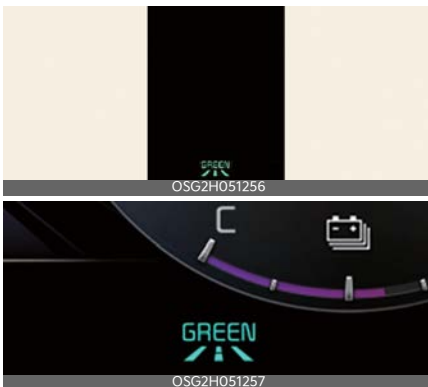

Enable Green Zone Drive Mode when entering green zone in ECO mode.

Green zone registration point

Based on navigation information and driving history.

1. School
2. Large hospitals
3. Registered favorites (Home/Office)
4. (Ultra) Low emission zone (For Europe/Plug-in hybrid vehicle only)

* INFORMATION

A change may occur through regular navigation updates.

⚠ CAUTION

Even in the Green Zone, the EV mode driving ability may be reduced or the engine may start in the following situations:

- If the battery charge is low.
- If the engine power is required (acceleration/climbing/heating/cooling) or engine start is required for driving system operation.
- If Green Zone recognition is not possible due to navigation problems.

Forward Collision-Avoidance Assist (FCA) (Front Camera Only) (if equipped)



Forward Collision-Avoidance Assist is designed to help detect and monitor the vehicle ahead or help detect pedestrian or cyclist in the roadway and warn the driver that a collision is imminent with a warning message and an audible warning, apply emergency braking.

- Never install any accessories or stickers on the front windshield, or tint the front windshield.
- Pay extreme caution to keep the front view camera dry.
- Never place any reflective objects (for example, white paper, mirror) over the dashboard.
- Do not place any objects near the front windshield or install any accessories on the front windshield. It can affect the performance of the defogging and defrosting function of the climate control system, which may prevent the Driver Assistance systems from operating.

Detecting sensor

Front view camera



Refer to the picture above for the detailed location of the detecting sensors.

CAUTION

- Never disassemble the detecting sensor or sensor assembly, or cause any damage to it.
- If the detecting sensors have been replaced or repaired, have the vehicle inspected by a professional workshop. Kia recommends visiting an authorized Kia dealer/service partner.

Forward Collision-Avoidance Assist settings

Forward safety



A: Driver Assistance

1 Driving Safety

2 Forward Safety

With the vehicle on, touch **Settings** → **Driver Assistance** → **Driving Safety** on the instrument cluster or **Settings** → **Vehicle** → **Driver Assistance** → **Driving Safety** on the infotainment system. The

initial warning activation timing of Forward Collision-Avoidance Assist can be changed.

- **Forward Safety:** Depending on the collision risk levels, an audible warning will sound, steering wheel will vibrate (if equipped) and the braking will be assisted. If the following menu is deactivated, Forward Collision-Avoidance Assist will turn off and the warning light (🚗) will appear on the cluster.

The driver can monitor Forward Collision-Avoidance Assist On/Off status from the Settings menu. If the warning light (🚗) remains ON when Forward Collision-Avoidance Assist is on, have the vehicle inspected by a professional workshop. Kia recommends visiting an authorized Kia dealer/service partner.

⚠️ WARNING

When the vehicle is restarted, Forward Collision-Avoidance Assist will always turn on. However, if **Forward safety** is deselected, the driver should always be aware of the surroundings and drive safely.

⚠️ CAUTION

- Steering wheel vibration (if equipped) can be turned on or off.
- When the trailer is connected, Forward Collision-Avoidance Assist automatically turns off (if equipped). In this case, you cannot get help from Forward Collision-Avoidance Assist. Always drive with care.

Warning timing



A: Driving Safety

1 Forward Safety Warning Timing

2 Normal

3 Late

With the vehicle on, touch **Settings** → **Driver Assistance** → **Driving Safety** → **Forward Safety Warning Timing** on the instrument cluster or **Settings** → **Vehicle** → **Driver Assistance** → **Driving Safety** → **Forward Safety Warning Timing** on the infotainment system to change the initial warning activation timing of Forward Collision-Avoidance Assist.

- Use **Normal** in normal driving conditions. If the Warning Timing seems sensitive, change it to **Late**.
- If **Late** is selected, Forward Collision-Avoidance Assist, warns the driver more slowly.

Warning volume



A: Driver Assistance

1 Warning Volume

2 Driving Safety Priority

3 High

4 Medium

5 Low

6 Off (If steering wheel vibration function is equipped)

With the vehicle on, touch **Settings** → **Driver Assistance** → **Warning Volume** on the instrument cluster or **Settings** → **Vehicle** → **Driver Assistance** → **Warning Volume** on the infotainment system to change the Warning volume to adjust the Warning volume levels; **High**, **Medium**, **Low** or **Off**.

If **Driving Safety Priority** is selected, the audio volume will temporarily decrease to warn the driver with the audible warning for safe driving.

CAUTION

- The setting of the Warning Timing and Warning Volume applies to all functions of Forward Collision-Avoidance Assist.
- Even though **Normal** is selected for Warning Timing, if the front vehicle

suddenly stops, the warning may seem late.

- Select **Late** for Warning Timing when traffic is light and when driving speed is slow.

* NOTICE

- If the vehicle is restarted, Warning timing and Warning volume will maintain the last setting.
- If **Off** is selected, the Warning volume of Forward Collision-Avoidance Assist will not turn off, but the volume will sound as **Low**.
- If **Off** is selected, steering wheel vibration (if equipped) will not turn off.
- If you change the Warning volume, the Warning volume of other Driver Assistance systems may change.

Forward Collision-Avoidance Assist operation

Basic function

The basic function for Forward Collision-Avoidance Assist is warned and controlled by the following level.

- Collision warning
- Emergency braking
- Stopping vehicle and ending brake control

Collision warning



A: Collision warning!

Collision warning will alert the driver with a warning message, an audible warning and steering wheel vibration (if equipped).

Collision Warning will be activated in the following conditions.

- Your driving speed: 10~180 km/h (6~112 mph)
- Pedestrian or cyclist: 10~80 km/h (6~50 mph)

Emergency braking



A: Emergency braking

The warning message, an audible warning and the steering wheel will vibrate (if equipped) to warn the driver that emergency braking will be assisted. The brake assist will be activated and it helps avoiding collision of a vehicle, pedestrian and cyclist.

Emergency braking will be activated in the following conditions.

- Your driving speed: 10~60 km/h (6~37 mph)
- Pedestrian or cyclist: 10~60 km/h (6~37 mph)

⚠ CAUTION

The function operation range may decrease due to the front traffic condition or the surroundings of the vehicle.

Stopping vehicle and ending brake control



A: Drive carefully

When the vehicle is stopped due to emergency braking, the warning message will appear on the cluster.

For your safety, the driver should depress the brake pedal immediately and check the surroundings.

- Brake control will end after the vehicle is stopped by emergency braking for approximately 2 seconds.

⚠ WARNING

- For your safety, change the Settings after parking the vehicle at a safe location.
- The driver should hold the responsibility to control the vehicle. Do not solely depend on Forward Collision-Avoidance Assist. Rather, maintain a safe braking distance, and if necessary, depress the brake pedal to reduce driving speed or to stop the vehicle.
- Never deliberately operate Forward Collision-Avoidance Assist on people, objects, etc. It may cause serious injury or death.

- Forward Collision-Avoidance Assist may not operate if the driver depresses the brake pedal to avoid collision.
- Depending on the road and driving conditions, Forward Collision-Avoidance Assist may warn the driver late or may not warn the driver.
- During Forward Collision-Avoidance Assist operation, the vehicle may stop suddenly injuring passengers and shifting loose objects. Always have the seat belt on and keep loose objects secured.
- If any other system's warning message is displayed or audible warning is generated, Forward Collision-Avoidance Assist warning message may not be displayed and audible warning may not be generated.
- You may not hear the warning sound of Forward Collision-Avoidance Assist if the surrounding is noisy.
- Forward Collision-Avoidance Assist may turn off or may not operate properly or may operate unnecessarily depending on the road conditions and the surroundings.
- Even if there is a problem with Forward Collision-Avoidance Assist, the vehicle's basic braking performance will operate properly.
- During emergency braking, braking control by Forward Collision-Avoidance Assist will automatically cancel when the driver excessively depresses the accelerator pedal or sharply steers the vehicle.

operate Forward Collision-Avoidance Assist may reduce. Forward Collision-Avoidance Assist may only warn the driver, or it may not operate.

*** NOTICE**

- In a situation where collision is imminent, braking may be assisted by Forward Collision-Avoidance Assist when braking is insufficient by the driver.
- The images and colors in the instrument cluster may differ depending on the cluster type or theme selected from the settings menu.

Forward Collision-Avoidance Assist malfunction and limitations

Forward Collision-Avoidance Assist malfunction



A: Check forward safety systems

When Forward Collision-Avoidance Assist is not working properly, the warning message will appear, and the (A) and (⚠️) warning lights will appear on the cluster. Kia recommends visiting an authorized Kia dealer/service partner.

⚠️ CAUTION

Depending on the condition of the vehicle, pedestrian and cyclist in front and the surroundings, the speed range to

Forward Collision-Avoidance Assist disabled

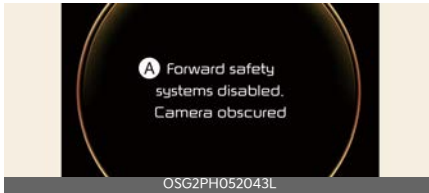

A: Forward safety systems disabled. Camera obscured

When the front windshield where the front view camera is located, front radar cover or sensor is covered with foreign material, such as snow or rain, it can reduce the detecting performance and temporarily limit or disable Forward Collision-Avoidance Assist.

If this occurs the warning message, and the (A) and (A) warning lights will appear on the cluster.

Forward Collision-Avoidance Assist will operate properly when snow, rain or foreign material is removed.

If Forward Collision-Avoidance Assist does not operate properly after obstruction (snow, rain, or foreign material) is removed, Kia recommends visiting an authorized Kia dealer/service partner.

WARNING

- Even though the warning message or warning light does not appear on the cluster, Forward Collision-Avoidance Assist may not properly operate.
- Forward Collision-Avoidance Assist may not properly operate in an area (for example, open terrain), where any objects are not detected after turning ON the vehicle.

Limitations of Forward Collision-Avoidance Assist

Forward Collision-Avoidance Assist may not operate properly, or it may operate unexpectedly under the following circumstances:

- The detecting sensor or the surroundings are contaminated or damaged
- The temperature around the front view camera is high or low due to surrounding environment
- The camera lens is contaminated due to tinted, filmed or coated windshield, damaged glass, or sticky foreign material (sticker, bug, etc.) on the glass
- Moisture is not removed or frozen on the windshield
- Washer fluid is continuously sprayed, or the wiper is on
- Driving in heavy rain or snow, or thick fog
- The field of view of the front view camera is obstructed by sun glare
- Street light or light from an oncoming traffic is reflected on the wet road surface, such as a puddle on the road
- An object is placed on the dashboard
- Your vehicle is being towed
- The surrounding is very bright or the surrounding is very dark, such as in a tunnel, etc.
- The brightness changes suddenly, for example when entering or exiting a tunnel
- The brightness outside is low, and the headlamps are not on or are not bright
- Only part of the vehicle, pedestrian or cyclist is detected

- The vehicle or motorcycle in front is a bus, heavy truck, truck with an unusually shaped cargo, trailer, etc.
- The vehicle in front has no tail lights, tail lights are located unusually, etc.
- The brightness outside is low, and the tail lamps are not on or are not bright
- The rear of the front vehicle is small or the vehicle does not look normal, such as when the vehicle is tilted, overturned, or the side of the vehicle is visible, etc.
- The front vehicle's ground clearance is low or high
- A vehicle, pedestrian or cyclist suddenly cuts in front
- The vehicle in front is detected late
- The vehicle in front is suddenly blocked by an obstacle
- The vehicle in front suddenly changes lane or suddenly reduces speed
- The vehicle in front is bent out of shape
- The front vehicle speed is fast or slow
- The vehicle in front steers in the opposite direction of your vehicle to avoid a collision
- With a vehicle in front, your vehicle changes lane at low speed
- The vehicle in front is covered with snow
- You are departing or returning to the lane
- Unstable driving
- You are on a roundabout and the vehicle or motorcycle in front is not detected
- You are continuously driving in a circle
- The vehicle in front has an unusual shape

- The vehicle in front is driving uphill or downhill
- The pedestrian or cyclist is not fully detected, for example, if the pedestrian is leaning over or is not fully walking upright
- The pedestrian or cyclist is wearing clothing or equipment that makes it difficult to detect



The illustration above shows the image the front view camera and front radar are capable of detecting as a vehicle, pedestrian and cyclist.

- The pedestrian or cyclist in front is moving very quickly
- The pedestrian or cyclist in front is short or is posing a low posture
- The pedestrian or cyclist in front has impaired mobility or moving intersected with the driving direction
- There is a group of pedestrians, cyclists or a large crowd in front
- The pedestrian or cyclist is wearing clothing that easily blends into the background, making it difficult to detect
- The pedestrian or cyclist is difficult to distinguish from the similarly shaped structure in the surroundings
- You are driving by a pedestrian, cyclist, traffic signs, structures, etc., near the intersection
- When driving in the following places
 - Driving through steam, smoke or shadow

- Driving through a tunnel or iron bridge
- Driving in large areas where there are few vehicles or structures (i.e. desert, meadow, suburb, etc.)
- Driving in a parking lot
- Driving through toll gate, construction areas, partially paved roads, bumpy roads, speed bumps, etc.
- Driving near areas containing metal substances, such as a construction zone, railroad, etc.
- Driving on an incline road, curved road, etc.
- Driving through a roadside with trees or streetlights
- Driving through a narrow road where trees or grass are overgrown
- There is interference by electromagnetic waves, such as driving in an area with strong radio waves or electrical noise
- The adverse road conditions cause excessive vehicle vibrations while driving
- Your vehicle height is low or high due to heavy loads, abnormal tire pressure, etc.

⚠ WARNING

- Driving on a curved road



Forward Collision-Avoidance Assist may not detect other vehicles, pedestrians or cyclists in front of you when driving on curved roads adversely affecting the performance of the sen-

sors. This may result in no warning, braking assist when necessary.

When driving on a curve, you must maintain a safe braking distance, and if necessary, steer the vehicle and depress the brake pedal to reduce your driving speed in order to maintain a safe distance.



Forward Collision-Avoidance Assist may detect a vehicle, pedestrian or cyclist in the next lane or outside the lane when driving on a curved road.

If this occurs, Forward Collision-Avoidance Assist may unnecessarily warn the driver and control the brake. Always check the traffic conditions around the vehicle.

- Driving on an inclined road



Forward Collision-Avoidance Assist may not detect other vehicles, pedestrians or cyclists in front of you while driving uphill or downhill, adversely affecting the performance of the sensors.

This may result in unnecessary warning, braking assist or no warning, braking assist when necessary.

Also, vehicle speed may rapidly decrease when a vehicle, pedestrian or cyclist ahead is suddenly detected. Always have your eyes on the road while driving uphill or downhill and if necessary, steer your vehicle and depress the brake pedal to reduce your driving speed in order to maintain a safe distance.

- Changing lanes



[A]: Your vehicle,
[B]: Lane changing vehicle
When a vehicle (B) moves into your lane from an adjacent lane, it cannot be detected by the sensor until it is in the sensor's detection range. Forward Collision-Avoidance Assist may not immediately detect the vehicle when the vehicle changes lanes abruptly. In this case, you must maintain a safe braking distance, and if necessary, steer your vehicle and depress the brake pedal to reduce your driving speed in order to maintain a safe distance.



[A]: Your vehicle,
[B]: Lane changing vehicle,
[C]: Same lane vehicle
When a vehicle (B) in front of you merges out of the lane, Forward Collision-Avoidance Assist may not immediately detect the vehicle (C) that is now in front of you. In this case, you must maintain a safe braking distance, and if necessary, steer your vehicle and depress the brake pedal to reduce your driving speed in order to maintain a safe distance.

- Detecting vehicle



If the vehicle in front of you has cargo that extends rearward from the cab,

or when the vehicle in front of you has higher ground clearance, additional special attention is required. Forward Collision-Avoidance Assist may not be able to detect the cargo extending from the vehicle. In these instances, you must maintain a safe braking distance from the rearmost object, and if necessary, steer your vehicle and depress the brake pedal to reduce your driving speed in order to maintain distance.

⚠ WARNING

- When you are towing a trailer or another vehicle, turn off Forward Collision-Avoidance Assist for safety reasons.
- Forward Collision-Avoidance Assist may operate if objects that are similar in shape or characteristics to vehicles, motorcycles, pedestrians and cyclists are detected.
- Forward Collision-Avoidance Assist does not operate on bicycles, or smaller wheeled objects, such as luggage bags, shopping carts, or strollers.
- Forward Collision-Avoidance Assist may not operate properly if interfered by strong electromagnetic waves.
- Forward Collision-Avoidance Assist may not operate for 15 seconds after the vehicle is started, or the front view camera is initialized.

Forward Collision-Avoidance Assist (FCA) (Sensor Fusion) (if equipped)

Basic function



Forward Collision-Avoidance Assist is designed to help detect and monitor the vehicle ahead or help detect a powered two-wheeler, pedestrian or cyclist in the roadway and warn the driver that a collision is imminent with a warning message and warning and apply emergency braking.

Junction Turning function

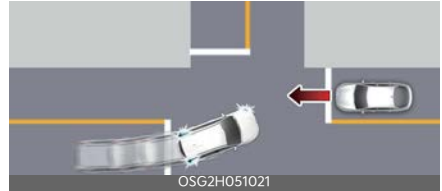

Junction Turning function can help avoid a collision with an oncoming vehicle in an adjacent lane when turning left (left-hand drive) or right (right-hand drive) at a crossroad with the turn signal on by applying emergency braking.

Detecting sensor

Front view camera



Front radar



Refer to the picture above for the detailed location of the detecting sensors.

⚠ CAUTION

Take the following precautions to maintain optimal performance of the detecting sensor:

- Never disassemble the detecting sensor or sensor assembly, or cause any damage to it.
- If the detecting sensors have been replaced or repaired, have the vehicle inspected by a professional workshop. Kia recommends visiting an authorized Kia dealer/service partner.
- Never install any accessories or stickers on the front windshield, or tint the front windshield.
- Pay extreme caution to keep the front view camera dry.
- Never place any reflective objects (for example, white paper, mirror) over the dashboard.
- Do not place any objects near the front windshield or install any acces-

sories on the front windshield. It can affect the performance of the defogging and defrosting function of the climate control system, which may prevent the Driver Assistance systems from operating.

- Do not apply license plate frame or objects, such as a bumper sticker, film or a bumper guard, near the front radar cover.
- Always keep the front radar and cover clean and free of dirt and debris. Use only a soft cloth to wash the vehicle. Do not spray pressurized water directly on the sensor or sensor cover.
- If the radar or around the radar has been damaged or impacted in any way, Forward Collision-Avoidance Assist may not properly operate even though a warning message does not appear on the cluster. Have the vehicle inspected by a professional workshop. Kia recommends visiting an authorized Kia dealer/service partner.
- The genuine Kia front radar sensor covers are parts with quality and performance ensured. If arbitrarily applying paint on or changing the cover, the system may not function properly. Use only Kia Genuine Parts or those of an equivalent standard with proven quality and performance to repair or replace the radar sensor covers.

Forward Collision-Avoidance Assist settings

Forward safety



A: Driver Assistance

1 Driving Safety

2 Forward Safety

With the vehicle on, touch **Settings** → **Driver Assistance** → **Driving Safety** on the instrument cluster or **Settings** → **Vehicle** → **Driver Assistance** → **Driving Safety** on the infotainment system. The initial warning activation timing of Forward Collision-Avoidance Assist can be changed.

- **Forward Safety:** Depending on the collision risk levels, an audible warning will sound, steering wheel will vibrate (if equipped) and the braking will be assisted. If the following menu is deactivated, Forward Collision-Avoidance Assist will turn off and the warning light (🚗) will appear on the cluster.

The driver can monitor Forward Collision-Avoidance Assist On/Off status from the Settings menu. If the warning light (🚗) remains ON when Forward Collision-Avoidance Assist is on, have

the vehicle inspected by a professional workshop. Kia recommends visiting an authorized Kia dealer/service partner.

⚠ WARNING

When the vehicle is restarted, Forward Collision-Avoidance Assist will always turn on. However, if **Forward Safety** is deselected, the driver should always be aware of the surroundings and drive safely.

⚠ CAUTION

- Steering wheel vibration (if equipped) can be turned on or off.
- When the trailer is connected, Forward Collision-Avoidance Assist automatically turns off (if equipped). In this case, you cannot get help from Forward Collision-Avoidance Assist. Always drive with care.

6

Warning timing



A: Driving safety

1 Forward Safety Warning Timing

2 Normal

3 Late

With the vehicle on, touch **Settings** → **Driver assistance** → **Driving safety** → **Forward Safety Warning Timing** on the instrument cluster or **Settings** → **Vehicle** → **Driver assistance** → **Driving safety** → **Forward Safety Warning Timing** on the infotainment system to change the initial warning activation timing of Forward Collision-Avoidance Assist.

- Use **Normal** in normal driving conditions. If the Warning Timing seems sensitive, change it to **Late**.
- If **Late** is selected, Forward Collision-Avoidance Assist, warns the driver more slowly.

Warning volume



- A: **Driver Assistance**
- 1 **Warning Volume**
 - 2 **Driving Safety Priority**
 - 3 **High**
 - 4 **Medium**
 - 5 **Low**
 - 6 **Off** (If steering wheel vibration function is equipped)

With the vehicle on, touch **Settings** → **Driver Assistance** → **Warning Volume** on the instrument cluster or **Settings** →

Vehicle → **Driver Assistance** → **Warning Volume** on the infotainment system to change the Warning volume to adjust the Warning volume levels; **High**, **Medium**, **Low** or **Off**.

If **Driving Safety Priority** is selected, the audio volume will temporarily decrease to warn the driver with the audible warning for safe driving.

⚠ CAUTION

- The setting of the Warning Timing and Warning Volume applies to all functions of Forward Collision-Avoidance Assist.
- Even though **Normal** is selected for Warning Timing, if the front vehicle suddenly stops, the warning may seem late.
- Select **Late** for Warning Timing when traffic is light and when driving speed is slow.

* NOTICE

- If the vehicle is restarted, Warning timing and Warning volume will maintain the last setting.
- If **Off** is selected, the Warning volume of Forward Collision-Avoidance Assist will not turn off, but the volume will sound as **Low**.
- If **Off** is selected, steering wheel vibration (if equipped) will not turn off.
- If you change the Warning volume, the Warning volume of other Driver Assistance systems may change.

Forward Collision-Avoidance Assist operation

Basic function

The basic function for Forward Collision-Avoidance Assist is warned and controlled by the following level.

- Collision warning
- Emergency braking
- Stopping vehicle and ending brake control

Collision warning



A: Collision warning!

Collision warning will alert the driver with a warning message, an audible warning and steering wheel vibration (if equipped).

Collision Warning will be activated in the following conditions.

- Your vehicle and powered two-wheeler: 10~200 km/h (6~124 mph)
- Pedestrian or cyclist: 10~85 km/h (6~53 mph)

Emergency braking



A: Emergency braking

The warning message, an audible warning and the steering wheel will vibrate (if equipped) to warn the driver that emer-

gency braking will be assisted. The brake assist will be activated and it helps avoiding collision of a vehicle, pedestrian and cyclist.

Emergency braking will be activated in the following conditions.

- Your vehicle and powered two-wheeler:

	Driving target	Stopped target
Weak braking power	10~200 km/h (6~124 mph)	
Strong braking power	10~130 km/h (6~80 mph)	10~75 km/h (6~47 mph)

- Pedestrian or cyclist: 10~65 km/h (6~40 mph)

⚠ CAUTION

The function operation range may decrease due to the front traffic condition or the surroundings of the vehicle.

Stopping vehicle and ending brake control



A: Drive carefully

When the vehicle is stopped due to emergency braking, the warning message will appear on the cluster.

For your safety, the driver should depress the brake pedal immediately and check the surroundings.

- Brake control will end after the vehicle is stopped by emergency braking for approximately 2 seconds.

Junction Turning function

The basic function for Junction turning function is warned and controlled by the following level.

- Collision warning
- Emergency braking
- Stopping vehicle and ending brake control

Collision warning



A: Collision warning!

Collision warning will alert the driver with a warning message, an audible warning and steering wheel vibration (if equipped).

Collision warning will be activated in the following conditions.

- Your driving speed: 10~30 km/h (6~19 mph)
- Oncoming vehicle speed: 30~70 km/h (19~44 mph)

Emergency braking



A: Emergency braking

The warning message, an audible warning and the steering wheel will vibrate (if equipped) to warn the driver that emergency braking will be assisted. The brake assist will be activated and it helps avoiding collision of a vehicle.

Emergency braking will be activated in the following conditions.

- Your driving speed: 10~30 km/h (6~19 mph)
- Oncoming vehicle speed: 30~70 km/h (19~44 mph)

Stopping vehicle and ending brake control



A: Drive carefully

When the vehicle is stopped due to emergency braking, the warning message will appear on the cluster. For your safety, the driver should depress the brake pedal immediately and check the surroundings.

- Brake control will end after the vehicle is stopped by emergency braking for approximately 2 seconds.

*** NOTICE**
For more details on warning messages, refer to "Collision warning" on page 6-57.

WARNING

- For your safety, change the Settings after parking the vehicle at a safe location.
- Forward Collision-Avoidance Assist does not operate in all situations or cannot avoid all collisions.
- The driver should hold the responsibility to control the vehicle. Do not solely depend on Forward Collision-Avoidance Assist. Rather, maintain a safe braking distance, and if neces-

sary, depress the brake pedal to reduce driving speed or to stop the vehicle.

- Never deliberately operate Forward Collision-Avoidance Assist on people, objects, etc. It may cause serious injury or death.
- Forward Collision-Avoidance Assist may not operate if the driver depresses the brake pedal to avoid collision.
- Depending on the road and driving conditions, Forward Collision-Avoidance Assist may warn the driver late or may not warn the driver.
- During Forward Collision-Avoidance Assist operation, the vehicle may stop suddenly injuring passengers and shifting loose objects. Always have the seat belt on and keep loose objects secured.
- If any other system's warning message is displayed or audible warning is generated, Forward Collision-Avoidance Assist warning message may not be displayed and audible warning may not be generated.
- You may not hear the warning sound of Forward Collision-Avoidance Assist if the surrounding is noisy.
- Forward Collision-Avoidance Assist may turn off or may not operate properly or may operate unnecessarily depending on the road conditions and the surroundings.
- Even if there is a problem with Forward Collision-Avoidance Assist, the vehicle's basic braking performance will operate properly.
- During emergency braking, braking control by Forward Collision-Avoidance Assist will automatically cancel when the driver excessively depresses

the accelerator pedal or sharply steers the vehicle.

⚠ CAUTION

- Depending on the condition of the vehicle, motorcycle, pedestrian and cyclist in front and the surroundings, the speed range to operate Forward Collision-Avoidance Assist may reduce. Forward Collision-Avoidance Assist may only warn the driver, or it may not operate.
- Forward Collision-Avoidance Assist will operate under certain conditions by judging the risk level based on the condition of the oncoming vehicle, driving direction, speed and surroundings.

* NOTICE

- In a situation where collision is imminent, braking may be assisted by Forward Collision-Avoidance Assist when braking is insufficient by the driver.
- The images and colors in the instrument cluster may differ depending on the cluster type or theme selected from the settings menu.

Forward Collision-Avoidance Assist malfunction and limitations

Forward Collision-Avoidance Assist malfunction



A: Check forward safety systems

When Forward Collision-Avoidance Assist is not working properly, the warning message will appear, and the (🚨) and (⚠️) warning lights will appear on the cluster. Kia recommends visiting an authorized Kia dealer/service partner.

Forward Collision-Avoidance Assist disabled



A: Forward safety systems disabled. Camera obscured

When the front windshield where the front view camera is located, front radar cover or sensor is covered with foreign material, such as snow or rain, it can reduce the detecting performance and temporarily limit or disable Forward Collision-Avoidance Assist.

If this occurs the warning message, and the (🚨) and (⚠️) warning lights will appear on the cluster.

Forward Collision-Avoidance Assist will operate properly when snow, rain or foreign material is removed.

If Forward Collision-Avoidance Assist does not operate properly after obstruction (snow, rain, or foreign material) is removed Kia recommends visiting an authorized Kia dealer/service partner.

⚠️ WARNING

- Even though the warning message or warning light does not appear on the cluster, Forward Collision-Avoidance Assist may not properly operate.
- Forward Collision-Avoidance Assist may not properly operate in an area

(for example, open terrain) or when the sensor is covered with foreign material, such as snow or rain, any objects are not detected after turning ON the vehicle.

Limitations of Forward Collision-Avoidance Assist

Forward Collision-Avoidance Assist may not operate properly, or it may operate unexpectedly under the following circumstances:

- The detecting sensor or the surroundings are contaminated or damaged
- The temperature around the front view camera is high or low due to surrounding environment
- The camera lens is contaminated due to tinted, filmed or coated windshield, damaged glass, or sticky foreign material (sticker, bug, etc.) on the glass
- Moisture is not removed or frozen on the windshield
- Washer fluid is continuously sprayed, or the wiper is on
- Driving in heavy rain or snow, or thick fog
- The field of view of the front view camera is obstructed by sun glare
- Street light or light from an oncoming traffic is reflected on the wet road surface, such as a puddle on the road
- An object is placed on the dashboard
- Your vehicle is being towed
- The surrounding is very bright or the surrounding is very dark, such as in a tunnel, etc.
- The brightness changes suddenly, for example when entering or exiting a tunnel

- The brightness outside is low, and the headlamps are not on or are not bright
- Only part of the vehicle, powered two-wheeler, pedestrian or cyclist is detected
- The vehicle or powered two-wheeler in front is a bus, heavy truck, truck with an unusually shaped cargo, trailer, etc.
- The vehicle or powered two-wheeler in front has no tail lights, tail lights are located unusually, etc.
- The brightness outside is low, and the tail lamps are not on or are not bright
- The rear of the front vehicle is small or the vehicle does not look normal, such as when the vehicle is tilted, over-turned, or the side of the vehicle is visible, etc.
- The front vehicle's ground clearance is low or high
- A vehicle, powered two-wheeler, pedestrian or cyclist suddenly cuts in front
- The bumper around the front radar is impacted, damaged or the front radar is out of position
- The temperature around the front radar is high or low
- Driving through a tunnel or iron bridge
- Driving in vast areas where there are few vehicles or structures (for example, desert, meadow, suburb, etc.)
- Driving near areas containing metal substances, such as a construction zone, railroad, etc.
- A material is near that reflects very well on the front radar, such as a guardrail, nearby vehicle, etc.
- The cyclist in front is on a bicycle made of material that does not reflect on the front radar
- The vehicle or powered two-wheeler in front is detected late
- The vehicle or powered two-wheeler in front is suddenly blocked by an obstacle
- The vehicle or powered two-wheeler in front suddenly changes lane or suddenly reduces speed
- The vehicle or powered two-wheeler in front is bent out of shape
- The front vehicle or powered two-wheeler or motorcycle speed is fast or slow
- The vehicle or powered two-wheeler in front steers in the opposite direction of your vehicle to avoid a collision
- With a vehicle or powered two-wheeler in front, your vehicle changes lane at low speed
- The vehicle in front is covered with snow
- You are departing or returning to the lane
- Unstable driving
- You are on a roundabout and the vehicle or powered two-wheeler in front is not detected
- You are continuously driving in a circle
- The vehicle in front has an unusual shape
- The vehicle in front is driving uphill or downhill
- The pedestrian or cyclist is not fully detected, for example, if the pedestrian is leaning over or is not fully walking upright

- The pedestrian or cyclist is wearing clothing or equipment that makes it difficult to detect



The illustration above shows the image the front view camera and front radar are capable of detecting as a vehicle, powered two-wheeler, pedestrian and cyclist.

- The pedestrian or cyclist in front is moving very quickly
- The pedestrian or cyclist in front is short or is posing a low posture
- The pedestrian or cyclist in front has impaired mobility or moving intersected with the driving direction
- There is a group of pedestrians, cyclists or a large crowd in front
- The pedestrian or cyclist is wearing clothing that easily blends into the background, making it difficult to detect
- The pedestrian or cyclist is difficult to distinguish from the similarly shaped structure in the surroundings
- You are driving by a pedestrian, cyclist, traffic signs, structures, etc., near the intersection
- When driving in the following places
 - Driving through steam, smoke or shadow
 - Driving through a tunnel or iron bridge
 - Driving in large areas where there are few vehicles or structures (i.e. desert, meadow, suburb, etc.)

- Driving in a parking lot
- Driving through toll gate, construction areas, partially paved roads, bumpy roads, speed bumps, etc.
- Driving near areas containing metal substances, such as a construction zone, railroad, etc.
- Driving on an incline road, curved road, etc.
- Driving through a roadside with trees or streetlights
- Driving through a narrow road where trees or grass are overgrown
- There is interference by electromagnetic waves, such as driving in an area with strong radio waves or electrical noise
- The adverse road conditions cause excessive vehicle vibrations while driving
- Your vehicle height is low or high due to heavy loads, abnormal tire pressure, etc.

⚠ WARNING

- Driving on a curved road



Forward Collision-Avoidance Assist may not detect other vehicles, powered two-wheelers, pedestrians or cyclists in front of you when driving on curved roads adversely affecting the performance of the sensors. This may result in no warning, braking assist when necessary.

When driving on a curve, you must maintain a safe braking distance, and

if necessary, steer the vehicle and depress the brake pedal to reduce your driving speed in order to maintain a safe distance.



Forward Collision-Avoidance Assist may detect a vehicle, powered two-wheeler, pedestrian or cyclist in the next lane or outside the lane when driving on a curved road.

If this occurs, Forward Collision-Avoidance Assist may unnecessarily warn the driver and control the brake. Always check the traffic conditions around the vehicle.

- Driving on an inclined road



Forward Collision-Avoidance Assist may not detect other vehicles, powered two-wheelers, pedestrians or cyclists in front of you while driving uphill or downhill, adversely affecting the performance of the sensors.

This may result in unnecessary warning, braking assist or no warning, braking assist when necessary.

Also, vehicle speed may rapidly decrease when a vehicle, powered two-wheeler, pedestrian or cyclist ahead is suddenly detected.

Always have your eyes on the road while driving uphill or downhill and if necessary, steer your vehicle and depress the brake pedal to reduce your driving speed in order to maintain a safe distance.

- Changing lanes



[A]: Your vehicle,

[B]: Lane changing vehicle

When a vehicle (B) moves into your lane from an adjacent lane, it cannot be detected by the sensor until it is in the sensor's detection range.

Forward Collision-Avoidance Assist may not immediately detect the vehicle when the vehicle changes lanes abruptly. In this case, you must maintain a safe braking distance, and if necessary, steer your vehicle and depress the brake pedal to reduce your driving speed in order to maintain a safe distance.



- [A]: Your vehicle,
- [B]: Lane changing vehicle,
- [C]: Same lane vehicle

When a vehicle (B) in front of you merges out of the lane, Forward Collision-Avoidance Assist may not immediately detect the vehicle (C) that is now in front of you. In this case, you must maintain a safe braking distance, and if necessary, steer your vehicle and depress the brake pedal to reduce your driving speed in order to maintain a safe distance.

- Detecting vehicle



If the vehicle in front of you has cargo that extends rearward from the cab, or when the vehicle in front of you has higher ground clearance, additional special attention is required. Forward Collision-Avoidance Assist may not be able to detect the cargo extending from the vehicle. In these instances, you must maintain a safe braking distance from the rearmost object, and if necessary, steer your vehicle and depress the brake pedal to reduce your driving speed in order to maintain distance.

⚠ WARNING

- When you are towing a trailer or another vehicle, turn off Forward Collision-Avoidance Assist for safety reasons.
- Forward Collision-Avoidance Assist may operate if objects that are similar in shape or characteristics to vehicles, motorcycles, pedestrians and cyclists are detected.
- Forward Collision-Avoidance Assist does not operate on bicycles, or smaller wheeled objects, such as luggage bags, shopping carts, or strollers.
- Forward Collision-Avoidance Assist may not operate properly if interfered by strong electromagnetic waves.
- Forward Collision-Avoidance Assist may not operate for 15 seconds after the vehicle is started, or the front view camera is initialized.

Lane Keeping Assist (LKA) (if equipped)

Lane Keeping Assist is designed to help detect lane markings (or road edges) while driving over a certain speed. Lane Keeping Assist will warn the driver if the vehicle leaves the lane without using the turn signal, or will automatically assist the driver's steering to help prevent the vehicle from departing the lane.

Detecting sensor

Front view camera



The front view camera is used as a detecting sensor to detect lane markings (or road edges).

Refer to the picture above for the detailed location of the detecting sensor.

⚠ CAUTION

For more details on the precautions of the front view camera, refer to "Forward Collision-Avoidance Assist (FCA) (Front Camera Only) (if equipped)" on page 6-44.

Lane Keeping Assist settings

Lane safety



A: Driver Assistance

1 Driving Safety 2 Lane Safety

With the vehicle on, touch **Settings** → **Driver Assistance** → **Driving Safety** on the instrument cluster or **Settings** → **Vehicle** → **Driver Assistance** → **Driving Safety** on the infotainment system.

- **Lane Safety:** If Lane safety is selected, Lane Keeping Assist will automatically assist the driver's steering when lane departure is detected to help prevent the vehicle from moving out of its lane. If Lane safety is off, the yellow indicator light (🚗) will appear on the cluster.

⚠ WARNING

- Lane Keeping Assist does not control the steering wheel when the vehicle is driven in the middle of the lane.
- The driver should always be aware of the surroundings and steer the vehicle if **Lane Safety** is deselected.

⚠ CAUTION

When the trailer is connected, Lane Keeping Assist automatically turns off (if equipped). In this case, you cannot get help from Lane Keeping Assist. Always drive with care.

Warning volume



A: Driver Assistance

- 1 Warning Volume
- 2 Driving Safety Priority
- 3 High
- 4 Medium
- 5 Low
- 6 Off (If steering wheel vibration function is equipped)

With the vehicle on, touch **Settings** → **Driver Assistance** → **Warning Volume** on the instrument cluster or **Settings** → **Vehicle** → **Driver Assistance** → **Warning Volume** on the infotainment system to change the Warning volume to adjust the Warning volume levels; **High**, **Medium**, **Low** or **Off**.

If **Driving Safety Priority** is selected, the audio volume will temporarily decrease

to warn the driver with the audible warning for safe driving.

*** NOTICE**

- If you change the Warning volume, the Warning volume of other Driver Assistance systems may change.
- If **Off** is selected, steering wheel vibration (if equipped) will not turn off.

Lane Keeping Assist operation

Turning Lane Keeping Assist On/Off



- Except Europe, Russia
With the vehicle on, press and hold the Lane Driving Assist button located on the steering wheel to turn on Lane Keeping Assist. The white (LKA) indicator light will appear on the cluster. Press and hold the Lane Driving Assist button again to turn off Lane Keeping Assist.
- For Europe, Russia
Whenever the vehicle is turned off and on, Lane Keeping Assist will always turn on and the white (LKA) indicator light will appear on the cluster.
Press and hold the Lane Driving Assist button to turn off Lane Keeping Assist.

*** NOTICE**

- When the Lane Driving Assist button is pressed shortly, Lane Following Assist will turn on and off.
- Whenever the vehicle is turned off and on, Lane safety settings will always retain its settings (Except Europe/Australia/Russia).

Warning and control

Left



Right



Lane Keeping Assist will warn and help control the vehicle with Lane Departure Warning and Lane Keeping Assist.

Lane Departure Warning

The green (LKA) indicator light and the lane line depending on which direction the vehicle is veering will blink on the cluster.

An audible warning and the steering wheel will vibrate (if equipped) to warn the driver that the vehicle is departing from the projected lane in front.

Lane departure warning will be activated in the following conditions.

- Your driving speed: Approximately 60~200 km/h (40~120 mph)

Lane Keeping Assist

The green (LKA) indicator light will blink on the cluster, and the steering wheel will make adjustments to warn the driver that the vehicle is departing from the projected lane in front.

Lane Keeping Assist will be activated in the following conditions.

- Your driving speed: Approximately 60~200 km/h (40~120 mph)

Hands-off warning



A: Keep hands on steering wheel

If the driver takes their hands off the steering wheel for several seconds, the warning message will appear on the cluster, and an audible warning will sound in stages.

⚠ WARNING

- The steering wheel may not be assisted if the steering wheel is held very tight or the steering wheel is steered over a certain degree.
- Lane Keeping Assist does not operate at all times. It is the responsibility of the driver to safely steer the vehicle and to maintain the vehicle in its lane.
- The hands-off warning message may appear late depending on road conditions. Always have your hands on the steering wheel while driving.
- If the steering wheel is held very lightly, the hands-off warning mes-

sage may appear because Lane Keeping Assist may not recognize that the driver has their hands on the steering wheel.

- If you attach objects to the steering wheel, the hands-off warning may not work properly.

*** NOTICE**

- For more details on setting the functions in the infotainment system Vehicle Settings, refer to "Vehicle settings (infotainment system) (if equipped)" on page 5-65.
- When lane markings (or road edges) are detected, the lane lines on the cluster will change from grey to white and the green (🚗) indicator light will appear.
- When lane markings (or road edges) are detected, the green lane lines on the cluster may appear.

Lane undetected



Lane detected



- The images and colors in the instrument cluster may differ depending on the cluster type or theme selected from the settings menu.

- Even though the steering is assisted by Lane Keeping Assist, the driver may control the steering wheel.
- The steering wheel may feel heavier or lighter when the steering wheel is assisted by Lane Keeping Assist than when it is not.

Lane Keeping Assist malfunction and limitations

Lane Keeping Assist malfunction

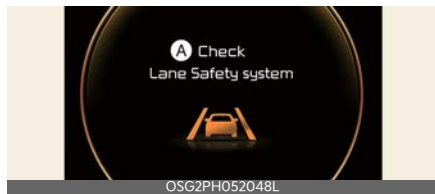

A: Check Lane Safety system

When Lane Keeping Assist is not working properly, the warning message will appear and the yellow (🚗) indicator light will appear on the cluster. If this occurs, have the function inspected by a professional workshop. Kia recommends visiting an authorized Kia dealer/service partner.

Limitations of Lane Keeping Assist

Lane Keeping Assist may not operate properly or may operate unexpectedly under the following circumstances:

- The lane is contaminated or difficult to detect because:
 - The lane markings (or road edge) are covered with rain, snow, dirt, oil, etc.
 - The color of the lane marking (or road edge) is not distinguishable from the road

- There are markings (or road edges) on the road near the lane or the markings (or road edges) on the road look similar to the lane markings (or road edge)
- The lane marking (or road edge) is indistinct or damaged
- The shadow is on the lane marking (or road edge) by a median strip, trees, guardrail, noise barriers, etc.
- The lane number increases or decreases, or the lane markings (or road edges) are crossing
- There are more than two lane markings (or road edges) on the road
- The lane markings (or road edges) are complicated or a structure substitutes for the lines, such as a construction area
- There are road markings, such as zig-zag lanes, crosswalk markings and road signs
- The lane suddenly disappears, such as at the intersection
- The lane (or road width) is very wide or narrow
- There is a road edge without a lane
- There is a boundary structure in the roadway, such as a tollgate, sidewalk, curb, etc.
- The distance to the front vehicle is extremely short or the vehicle in front is covering the lane marking (or road edge)

* NOTICE

For more details on the limitations of the front view camera, refer to "Forward Collision-Avoidance Assist (FCA) (Front Camera Only) (if equipped)" on page 6-44.

⚠ WARNING

- The driver should hold the responsibility to safely drive and control the vehicle. Do not solely rely on Lane Keeping Assist and drive dangerously.
- The operation of Lane Keeping Assist can be canceled or not work properly depending on road conditions and surroundings. Always be cautious while driving.
- Refer to "Limitations of Lane Keeping Assist" if the lane is not detected properly.
- When you are towing a trailer or another vehicle, turn off Lane Keeping Assist for safety reasons.
- If the vehicle is driven at high speed, the steering wheel will not be controlled. The driver must always follow the speed limit when using Lane Keeping Assist.
- If any other system's warning message is displayed or audible warning is generated, Lane Keeping Assist warning message may not be displayed and audible warning may not be generated.
- You may not hear the warning sound of Lane Keeping Assist if the surrounding is noisy. Adjust the vehicle volume moderately and always pay attention to the surrounding.
- If you attach objects to the steering wheel, steering may not be assisted properly.
- Lane Keeping Assist may not operate for 15 seconds after the vehicle is started, or the front view camera is initialized.
- Lane Keeping Assist will not operate when:

- The turn signal or hazard warning flasher is turned on.
- The vehicle is not driven in the center of the lane when Lane Keeping Assist is turned on or right after changing a lane.
- ESC (Electronic Stability Control) or VSM (Vehicle Stability Management) is activated.
- The vehicle is driven rapidly on a sharp curve.
- Vehicle speed is below 55 km/h (35 mph) or above 210 km/h (130 mph).
- The vehicle makes sharp lane changes.
- The vehicle brakes suddenly.

Blind-Spot Collision-Avoidance Assist (BCA) (if equipped)

Blind-Spot Collision-Avoidance Assist is designed to help detect and monitor approaching vehicles in the driver's blind spot area and warn the driver of a possible collision with a warning message and audible warning.

In addition, if there is a risk of collision when driving forward out of a parking space, Blind-Spot Collision-Avoidance Assist can help avoid a collision assisting with applying the brake.

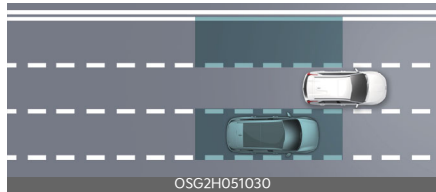

Blind-Spot Collision-Avoidance Assist helps detect and informs the driver that a vehicle is in the blind spot.

⚠ CAUTION

The detecting range may vary depending on the speed of your vehicle. Even if there is a vehicle in the blind spot area, Blind-Spot Collision-Avoidance Assist may not warn you when you pass by at high speeds.

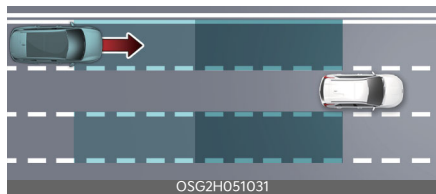

Blind-Spot Collision-Avoidance Assist helps detect and informs the driver that a vehicle is approaching at high speed from the blind spot area.

a vehicle is approaching at high speed from the blind spot area.

CAUTION

Warning timing may vary depending on the speed of the vehicle approaching at high speed.

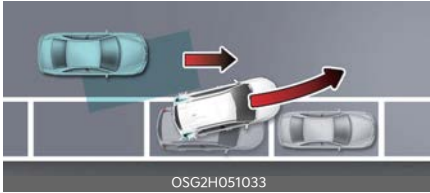

When you are driving forward out of a parking space, if Blind-Spot Collision-Avoidance Assist judges that there is a collision risk with an approaching vehicle in the blind spot, it can help avoid collision by applying the brake.

Detecting sensor

Rear corner radar



Refer to the picture above for the detailed location of the detecting sensors.

CAUTION

- Never disassemble the detecting sensor assembly, or cause any damage to it.
- If the detecting sensor or near the sensor has been damaged or impacted in any way, even though the warning message does not appear on the cluster, Blind-Spot Collision-Avoid-

ance Assist may not operate properly. Have the function be inspected by a professional workshop. Kia recommends visiting an authorized Kia dealer/service partner.

- If the detecting sensors have been replaced or repaired, have the vehicle inspected by a professional workshop. Kia recommends visiting an authorized Kia dealer/service partner.
- Use only Kia Genuine Parts or those of an equivalent standard to repair the rear bumper where the rear corner radar is located.
- Do not apply license plate frame or objects, such as a bumper sticker, film or a bumper guard near the rear corner radar.
- Blind-Spot Collision-Avoidance Assist may not work properly if the bumper have been replaced, or the surroundings of the rear corner radar has been damaged or paint has been applied.
- If a trailer, carrier, etc., is installed, it may adversely affect the performance of the rear corner radar or Blind-Spot Collision-Avoidance Assist may not operate.
- For more details on the precautions of the front view camera, refer to "Forward Collision-Avoidance Assist (FCA) (Front Camera Only) (if equipped)" on page 6-44.

Blind-Spot Collision-Avoidance Assist settings

Blind-spot safety



A: Driver Assistance

- 1 Driving Safety
- 2 Blind-Spot Safety

With the vehicle on, touch **Settings** → **Driver Assistance** → **Driving Safety** on the instrument cluster or **Settings** → **Vehicle** → **Driver Assistance** → **Driving Safety** on the infotainment system.

- **Blind-Spot Safety:** Blind-Spot Collision-Avoidance Assist will warn and braking assist will be applied depending on the collision risk levels.

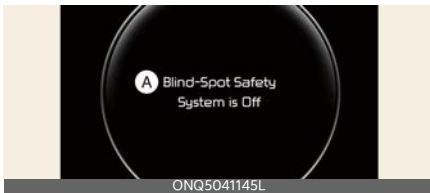

A: Blind-Spot Safety System is Off

When activating Blind-Spot Collision-Avoidance Assist or restarting the vehicle with this function activated, the warning light on the side mirrors will appear for approximately 3 seconds.

When the vehicle is restarted with Blind-Spot Collision-Avoidance Assist inactivated, the warning message will appear on the cluster.

⚠ WARNING

If **Blind-Spot Safety** is deselected, the driver should always be aware of the surroundings and drive safely.

⚠ CAUTION

When the trailer is connected, Blind-Spot Collision-Avoidance Assist automatically turns off (if equipped). In this case, you cannot get help from Blind-Spot Collision-Avoidance Assist. Always drive with care.

* NOTICE

If the vehicle is restarted, Blind-Spot Collision-Avoidance Assist will maintain the last setting.

Warning volume



A: Driver Assistance

- 1 Warning Volume
- 2 Driving Safety Priority

3 High**4 Medium****5 Low****6 Off** (If steering wheel vibration function is equipped)

With the vehicle on, touch **Settings** → **Driver Assistance** → **Warning Volume** on the instrument cluster or **Settings** → **Vehicle** → **Driver Assistance** → **Warning Volume** on the infotainment system to change the Warning volume to adjust the Warning volume levels; **High**, **Medium**, **Low** or **Off**.

If **Driving Safety Priority** is selected, the audio volume will temporarily decrease to warn the driver with the audible warning for safe driving.

*** NOTICE**

- If you change the Warning volume, the Warning volume of other Driver Assistance systems may change.
- If **Off** is selected, steering wheel vibration (if equipped) will not turn off.

⚠ CAUTION

The setting of the Warning volume applies to all functions of Blind-Spot Collision-Avoidance Assist.

Blind-Spot Collision-Avoidance Assist operation

Blind-Spot Collision-Avoidance Assist will warn and control as following operation.

- Vehicle detection
- Collision warning
- Collision-avoidance assist (while departing)

Vehicle detection

First warning (Left/Right)



The warning light on the outside rear view mirror (side view mirror) and head-up display (if equipped) will appear when the vehicle on both lanes is detected from the rear.

A vehicle is detected in the following conditions.

- Your driving speed: Above 20 km/h (12 mph)
- The speed of the vehicle in your blind spot area: Above 10 km/h (7 mph)

Collision warning

With the vehicle detection state, Collision warning will alert the driver when the turn signal is activated to make a lane change with an adjacent car in the blind spot area.

- Collision warning will alert the driver with the warning light on the outside rear view mirrors (side view mirrors) and head-up display (if equipped), audible warning and steering wheel vibration (if equipped).
- When the turn signal is turned off or you move away from the lane, the collision warning will be canceled and

the function will return to Vehicle detection state.

⚠ CAUTION

If **Warning only** is selected from the Settings menu, the collision warning will operate when your vehicle approaches the lane the blind spot vehicle is detected.

⚠ WARNING

- The detecting range of the front corner radar or rear corner radar is determined by a standard road width, therefore, on a narrow road, Blind-Spot Collision-Avoidance Assist may detect other vehicles two lanes over and warn you. In contrast, on a wide road, Blind-Spot Collision-Avoidance Assist may not be able to detect a vehicle driving in the next lane and may not warn you.
- When the hazard warning flasher is on, the collision warning by the turn signal will not operate.

*** NOTICE**

- If the driver's seat is on the left side, the collision warning may occur when you turn left. If the driver's seat is on the right side, the collision warning may occur when you turn right. Maintain a proper distance with the vehicles in the lane.
- Images or colors may be displayed differently depends on the instrument cluster specifications or theme.

Collision-avoidance assist (while departing)



A: Emergency braking

The warning light on the outside rear view mirror (side view mirror), head-up display (if equipped), an audible warning and the steering wheel vibration (if equipped) will warn the driver of a collision. It assists in braking control to prevent a collision with a vehicle approaching from the blind spot area. Collision-Avoidance Assist will be activated in the following conditions.

- Your driving speed: Below 3 km/h (2 mph)
- Speed of the vehicle in your blind spot area: Above 5 km/h (3 mph)



A: Drive carefully

When the vehicle is stopped due to emergency braking, the warning message will appear on the cluster. For your safety, the driver should depress the brake pedal immediately and check the surroundings.

- Brake control will end after the vehicle is stopped by emergency braking for approximately 2 seconds.

⚠ WARNING

- For your safety, change the Settings after parking the vehicle at a safe location.
- If any other system's warning message is displayed or audible warning is generated, Blind-Spot Collision-Avoidance Assist's warning message may not be displayed and audible warning may not be generated.
- You may not hear the warning sound of Blind-Spot Collision-Avoidance Assist if the surrounding is noisy.
- Blind-Spot Collision-Avoidance Assist may not operate if the driver applies the brake pedal to avoid collision.
- When Blind-Spot Collision-Avoidance Assist is operating, braking control by the function will automatically cancel when the driver excessively depresses the accelerator pedal or sharply steers the vehicle.
- During Blind-Spot Collision-Avoidance Assist operation, the vehicle may stop suddenly injuring passengers and shifting loose objects. Always have the seat belt on and keep loose objects secured.
- Even if there is a problem with Blind-Spot Collision-Avoidance Assist, the vehicle's basic braking performance will operate properly.
- Blind-Spot Collision-Avoidance Assist does not operate in all situations or cannot avoid all collisions.
- Blind-Spot Collision-Avoidance Assist may warn the driver late or may not warn the driver depending on the road and driving conditions.
- Driver should maintain control of the vehicle at all times. Do not depend on Blind-Spot Collision-Avoidance Assist.

Maintain a safe braking distance, and if necessary, depress the brake pedal to reduce driving speed or to stop the vehicle.

- Never operate Blind-Spot Collision-Avoidance Assist on people, animal, objects, etc. It may cause serious injury or death.

⚠ WARNING

The brake control may not operate properly depending on the status of ESC (Electronic Stability Control).

There will only be a warning when:

- The ESC (Electronic Stability Control) warning light is on
- ESC (Electronic Stability Control) is engaged in a different function

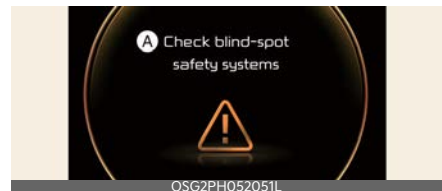
Blind-Spot Collision-Avoidance Assist malfunction and limitations**Blind-Spot Collision-Avoidance Assist malfunction****A: Check blind-spot safety systems**

When Blind-Spot Collision-Avoidance Assist is not working properly, the warning message will appear on the cluster for several seconds, and the master (⚠) warning light will appear on the cluster for several seconds. If this occurs, have Blind-Spot Collision-Avoidance Assist be inspected by a professional workshop. Kia recommends visiting an authorized Kia dealer/service partner.



A: Check outside mirror warning icon

When the outside rearview mirror warning light is not working properly, the warning message will appear on the cluster for several seconds, and the master (⚠) warning light will appear on the cluster. If this occurs, have Blind-Spot Collision-Avoidance Assist be inspected by a professional workshop. Kia recommends visiting an authorized Kia dealer/service partner.

Blind-Spot Collision-Avoidance Assist disabled

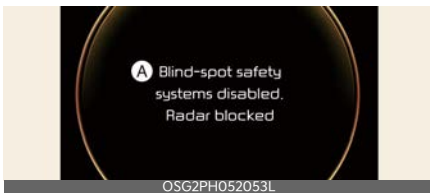

A: Blind-spot safety systems disabled. Radar blocked

When the rear bumper around the rear corner radar or sensor is covered with foreign material, such as snow or rain, or installing a trailer or carrier, it can reduce the detecting performance and temporarily limit or disable Blind-Spot Collision-Avoidance Assist.

If this occurs, the warning message will appear on the cluster.

Blind-Spot Collision-Avoidance Assist will operate properly when such foreign material or trailer, etc., is removed, and then the vehicle is restarted.

If Blind-Spot Collision-Avoidance Assist does not operate properly after it is removed, have Blind-Spot Collision-Avoidance Assist be inspected by a professional workshop. Kia recommends visiting an authorized Kia dealer/service partner.

⚠ WARNING

- Even though the warning message does not appear on the cluster, Blind-Spot Collision-Avoidance Assist may not properly operate.
- Blind-Spot Collision-Avoidance Assist may not properly operate in an area (for example, open terrain) where any objects are not detected right after the vehicle is turned on, or when the detecting sensor is blocked with foreign material right after the vehicle is turned on.

⚠ CAUTION

Turn off Blind-Spot Collision-Avoidance Assist to install or remove a trailer, carrier, or another attachment. Turn on Blind-Spot Collision-Avoidance Assist when finished.

Limitations of Blind-Spot Collision-Avoidance Assist

Blind-Spot Collision-Avoidance Assist may not operate properly, or it may operate unexpectedly under the following circumstances:

- There is inclement weather, such as heavy snow, heavy rain, etc.
- The detecting sensor is covered with snow, rain, dirt, etc.
- The temperature around the detecting sensor is high or low due to surrounding environment.

- The detecting sensor is blocked while driving near a vehicle, pillar, or wall.
- Driving on a highway (or motorway) ramp or driving through a tollgate.
- The road pavement (or the peripheral ground) abnormally contains metallic components (for example, possibly due to subway construction).
- There is a fixed object near the vehicle, such as sound barriers, guardrails, central dividers, entry barriers, street lamps, signs, tunnels, walls, etc. (including double structures)
- Driving through a narrow road where trees or grass are overgrown
- Driving in vast areas where there are few vehicles or structures (for example, desert, meadow, suburb, etc.)
- Driving on a wet road surface, such as a puddle on the road
- The other vehicle drives very close behind your vehicle, or the other vehicle passes by your vehicle in close proximity
- The speed of the other vehicle is very fast that it passes by your vehicle in a short time
- Your vehicle passes by the other vehicle
- Your vehicle changes lane
- Your vehicle has started at the same time as the vehicle next to you and has accelerated
- The vehicle in the next lane moves two lanes away from you, or when the vehicle two lanes away moves to the next lane from you
- A trailer or carrier is installed around the rear corner radar
- The bumper around the rear corner radar is covered with objects, such as a bumper sticker, bike rack, etc.
- The bumper around the rear corner radar is impacted, damaged or the radar is out of position
- Your vehicle height is low or high due to heavy loads, abnormal tire pressure, etc.
- When the following objects are detected:
 - A motorcycle or bicycle is detected
 - A vehicle such as a flat trailer is detected
 - A big vehicle such as a bus or truck is detected
 - A moving obstacle such as a pedestrian, animal, shopping cart or a baby stroller is detected
 - A vehicle with low height such as a sports car is detected

Braking control may not work, driver's attention is required in the following circumstances:

- The vehicle severely vibrates while driving over a bumpy road, uneven road or concrete patch
- Driving on a slippery surface due to snow, water puddle, ice, etc.
- The tire pressure is low or a tire is damaged
- The braking system has been modified
- The vehicle makes abrupt lane changes

*** NOTICE**

For more details on the limitations of the front view camera, refer to "Forward Collision-Avoidance Assist (FCA) (Front Camera Only) (if equipped)" on page 6-44.

⚠ WARNING

- Driving on a curved road



Blind-Spot Collision-Avoidance Assist may not operate properly when driving on a curved road. Blind-Spot Collision-Avoidance Assist may not detect the vehicle in the next lane. Always pay attention to road and driving conditions while driving.



Blind-Spot Collision-Avoidance Assist may not operate properly when driving on a curved road. Blind-Spot Collision-Avoidance Assist may detect a vehicle in the same lane. Always pay attention to road and driving conditions while driving.

- Driving on a sloped road

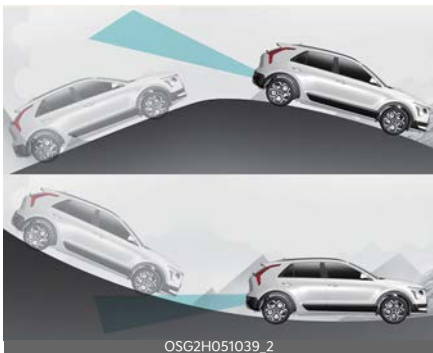

Blind-Spot Collision-Avoidance Assist may not operate properly when driving on a slope. The function may not detect the vehicle in the next lane or may incorrectly detect the ground or structure.

Always pay attention to road and driving conditions while driving.

- Driving where the road is merging/dividing



Blind-Spot Collision-Avoidance Assist may not operate properly when driving where the road merges or divides. The function may not detect the vehicle in the next lane.

Always pay attention to road and driving conditions while driving.

- Driving where the heights of the lanes are different



Blind-Spot Collision-Avoidance Assist may not operate properly when driving where the heights of the lanes are different. The function may not detect the vehicle on a road with different lane heights (underpass joining section, grade separated intersections, etc.).

Always pay attention to road and driving conditions while driving.

⚠ WARNING

- When you are towing a trailer or another vehicle, make sure that you turn off Blind-Spot Collision-Avoidance Assist.
- Blind-Spot Collision-Avoidance Assist may not operate properly if interfered by strong electromagnetic waves.
- Blind-Spot Collision-Avoidance Assist may not operate for 3 seconds after the vehicle is started, or the front view camera or rear corner radars are initialized.

Safe Exit Warning (SEW) (if equipped)



After the vehicle stops, when an approaching vehicle from the rear area is detected as soon as a passenger opens a door, Safe Exit Warning will warn the driver with a warning message and an audible warning to help prevent a collision.

⚠ CAUTION

Warning timing may vary depending on the speed of the approaching vehicle.

Detecting sensor

Rear corner radar



Refer to the picture above for the detailed location of the detecting sensors.

⚠ CAUTION

For more details on the precautions of the rear corner radars, refer to "Blind-Spot Collision-Avoidance Assist (BCA) (if equipped)" on page 6-70.

Safe Exit Warning settings

Setting features

Exit Safety

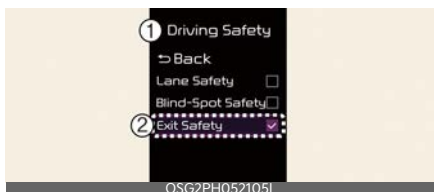

A: Driver Assistance

1 Driving Safety

2 Exit Safety

With the vehicle on, touch **Settings** → **Driver Assistance** → **Driving safety** → **Exit Safety** on the instrument cluster or **Settings** → **Vehicle** → **Driver Assistance** → **Driving Safety** → **Exit Safety** on the infotainment system.

WARNING

If **Exit Safety** is deselected, Safe Exit Warning cannot warn you. The driver should always be aware of unexpected and sudden situations from occurring.

CAUTION

When the trailer is connected, Safe Exit Warning automatically turns off (if equipped). In this case, you cannot get help from Safe Exit Warning. Always drive with care.

* NOTICE

If the vehicle is restarted, Safe Exit Warning will maintain the last setting.

Safe Exit Warning operation

Safe Exit Warning warns the following actions.

- Collision warning when exiting vehicle

Collision warning when exiting vehicle

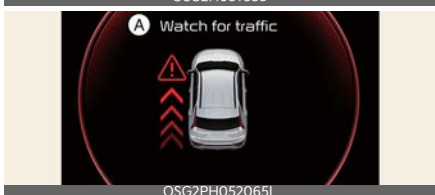

A: Watch for traffic

The warning light on the side view mirror will blink and the warning message will appear on the cluster, and an audible warning will sound.

- Safe Exit Warning will warn under the following circumstances:
 - Your driving speed: below 3 km/h (2 mph)
 - The speed of the approaching vehicle from the rear: above 6 km/h (4 mph)

⚠ WARNING

- For your safety, change the Settings after parking the vehicle at a safe location.
- If any other function's warning message is displayed or audible warning is generated, Safe Exit Warning warning message may not be displayed and audible warning may not be generated.
- You may not hear the warning sound of Safe Exit Warning if the surrounding is noisy.
- Safe Exit Warning does not operate in all situations or cannot prevent all collisions.
- Safe Exit Warning may warn the driver late or may not warn the driver depending and driving conditions. Always check vehicle surroundings.
- The driver and passengers are responsible for accidents that occurs while exiting the vehicle. Always check the surroundings before you exit the vehicle.

*** NOTICE**

- After the vehicle is turned off, Safe Exit Warning operates for approximately 3 minutes, but turns off immediately if the doors are locked.
- Images or colors may be displayed differently depends on the instrument cluster specifications or theme.

Safe Exit Warning malfunction and limitations

Safe Exit Warning malfunction

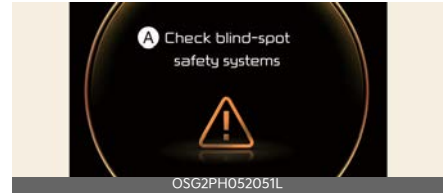

A: Check Blind-Spot Safety system

When Safe Exit Warning is not working properly, the warning message will appear on the cluster, and the master warning light (⚠) will appear on the cluster. Have Safe Exit Warning be inspected by a professional workshop. Kia recommends visiting an authorized Kia dealer/service partner.

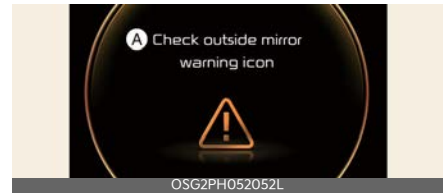

A: Check outside mirror warning icon

When the outside rear view mirror warning light is not working properly, the warning message will appear on the cluster for several seconds, and the master warning light (⚠) will appear on the cluster. Have Safe Exit Warning be inspected by a professional workshop. Kia recommends visiting an authorized Kia dealer/service partner.

Safe Exit Warning disabled

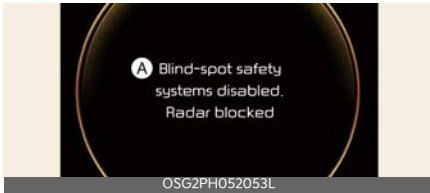

A: Blind-spot safety systems disabled. Radar blocked

When the rear bumper around the rear corner radar or sensor is covered with foreign material, such as snow or rain, or installing a trailer or carrier, it can reduce the detecting performance and temporarily limit or disable Safe Exit Warning.

If this occurs, the **Blind-Spot Safety systems disabled. Radar blocked** warning message will appear on the cluster.

Safe Exit Warning will operate normally when such foreign material or trailer, etc. is removed, and then the vehicle is restarted.

If Safe Exit Warning does not operate normally after it is removed, Kia recommends visiting an authorized Kia dealer/service partner.

⚠ WARNING

- Even though the warning message does not appear on the cluster, Safe Exit Warning may not properly operate.
- Safe Exit Warning may not properly operate in an area (e.g., open terrain), where any substance are not detected right after the vehicle is turned on, or when the detecting sensor is blocked with foreign material right after the vehicle is turned on.

⚠ CAUTION

Turn off Safe Exit Warning to install a trailer, carrier, etc., or remove the trailer, carrier, etc. to use Safe Exit Warning.

Limitations of Safe Exit Warning

Safe Exit Warning may not operate normally, or Safe Exit Warning may operate unexpectedly under the following warning.

- Getting out of the vehicle where trees or grass are overgrown
- Getting out of the vehicle where the road is wet
- The approaching vehicle is very fast or very slow

* NOTICE

For more details on the precautions of the rear corner radars, refer to "Blind-Spot Collision-Avoidance Assist (BCA) (if equipped)" on page 6-70.

⚠ WARNING

- Safe Exit Warning may not operate normally if interfered by strong electromagnetic waves.
- Safe Exit Warning may not operate for approximately 3 seconds after the vehicle is restarted, or the rear corner radars are initialized.

Safe Exit Assist (SEA) (if equipped)



After the vehicle stops, when an approaching vehicle from the rear area is detected after a passenger opens the door, Safe Exit Assist will warn the driver with a warning message and an audible warning to help prevent a collision.



When the electronic child safety lock button is in the LOCK position and an approaching vehicle from the rear area is detected, the electronic child safety lock () button will not unlock even if the driver presses the button to prevent the rear doors from opening.

CAUTION

Warning timing may vary depending on the speed of the approaching vehicle.

Detecting sensor

Rear corner radar



Refer to the picture above for the detailed location of the detecting sensors.

CAUTION

For more details on the precautions of the rear corner radars, refer to "Blind-Spot Collision-Avoidance Assist (BCA) (if equipped)" on page 6-70.

Safe Exit Assist settings

Exit Safety

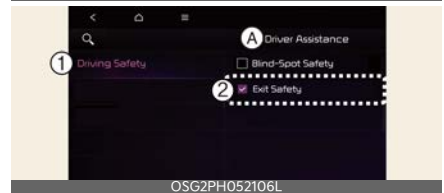
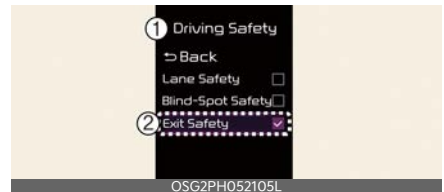

A: Driver Assistance

1 Driving Safety

2 Exit Safety

With the vehicle on, touch **Settings** → **Vehicle** → **Driver Assistance** → **Driving Safety** → **Exit Safety** on the instrument cluster or **Settings** → **Vehicle** → **Driver**

Assistance → Driving Safety → Exit Safety on the infotainment system.

⚠ WARNING

The driver should always be aware of his or her surroundings. If **Exit Safety** is deselected, Safe Exit Assist cannot assist you.

⚠ CAUTION

When the trailer is connected, Safe Exit Assist automatically turns off (if equipped). In this case, you cannot get help from Safe Exit Assist. Always drive with care.

*** NOTICE**

If the vehicle is restarted, Safe Exit Assist will maintain the last setting.

Safe Exit Assist operation

Safe Exit Assist warns the following actions.

- Collision warning when exiting vehicle
- Safe Exit Assist linked with Electronic child safety lock

Collision warning when exiting vehicle

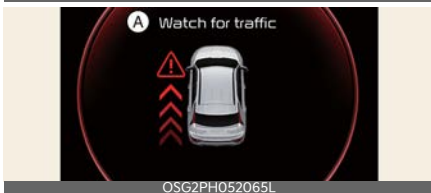

A: Watch for traffic

The warning light on the side view mirror will blink and the warning message will appear on the cluster, and an audible warning will sound.

- Collision warning when exiting vehicle will warn under the following circumstances:
 - Your driving speed: below 3 km/h (2 mph)
 - The speed of the approaching vehicle from the rear: above 6 km/h (4 mph)

Safe Exit Assist linked with Electronic child safety lock

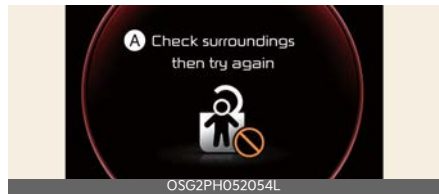

A: Check surroundings then try again

The warning light on the outside rear view mirror will blink and the warning message will appear on the cluster.

- Safe Exit Assist linked with Electronic child safety lock will operate in the following conditions:
 - Your driving speed: below 3 km/h (2 mph)
 - The speed of the approaching vehicle from the rear: above 6 km/h (4 mph)

*** NOTICE**

For more details on electric child safety lock button, refer to "Electronic child safety lock system (if equipped)" on page 5-16.

⚠ CAUTION

If the driver presses the electronic child safety lock button again within 10 seconds after the warning message appears, Safe Exit Assist judges that the driver has unlocked the doors acknowledging the rear status. The electronic child safety lock will turn off (button indicator OFF) and the rear doors will unlock. Always check the surroundings before turning off the electronic child safety lock button.

*** NOTICE**

If a rear door is opened from the outside, it will open regardless of Safe Exit Assist operation.

⚠ WARNING

- For your safety, change the Settings after parking the vehicle at a safe location.
- If any other system's warning message is displayed or audible warning is generated, Safe Exit Assist warning message may not be displayed and audible warning may not be generated.
- You may not hear the warning sound of Safe Exit Assist if the surrounding is noisy.
- Safe Exit Assist does not operate in all situations or cannot prevent all collisions.
- Safe Exit Assist may warn the driver late or may not warn the driver depending on the road and driving conditions. Always check vehicle surroundings.
- The driver and passengers are responsible for accidents that occurs while exiting the vehicle. Always check

the surroundings before you exit the vehicle.

- Never deliberately operate Safe Exit Assist. Doing so may lead to serious injury or death.

*** NOTICE**

- After the vehicle is turned off, Safe Exit Assist operates approximately for 3 minutes, but turns off immediately if the doors are locked.
- The images and colors in the instrument cluster may differ depending on the cluster type or theme selected from the settings menu.

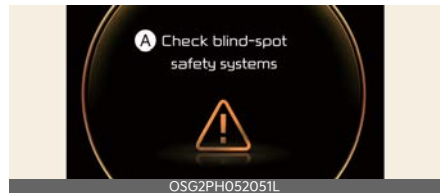
Safe Exit Assist malfunction and limitations**Safe Exit Assist malfunction****A: Check blind-spot safety systems**

When Safe Exit Assist is not working properly, the warning message will appear on the cluster for several seconds, and the master (⚠) warning light will appear on the cluster. Have Safe Exit Assist be inspected by a professional workshop. Kia recommends visiting an authorized Kia dealer/service partner.

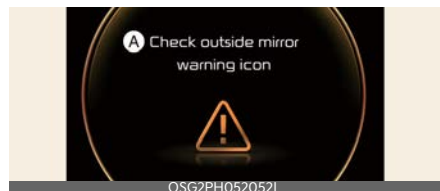

A: Check outside mirror warning icon

When the outside rearview mirror warning light is not working properly, the warning message will appear on the cluster for several seconds, and the master (▲) warning light will appear on the cluster. Have Safe Exit Assist be inspected by a professional workshop. Kia recommends visiting an authorized Kia dealer/service partner.

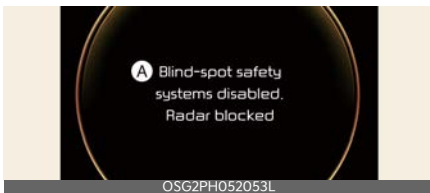
Safe Exit Assist disabled**A: Blind-spot safety systems disabled. Radar blocked**

When the rear bumper around the rear corner radar or sensor is covered with foreign material, such as snow or rain, or installing a trailer or carrier, it can reduce the detecting performance and temporarily limit or disable Safe Exit Assist.

If this occurs, the warning message will appear on the cluster.

Safe Exit Assist will operate properly when such foreign material or trailer, etc., is removed, and then the vehicle is restarted.

If Safe Exit Assist does not operate properly after it is removed, Kia recommends visiting an authorized Kia dealer/service partner.

▲ WARNING

- Even though the warning message does not appear on the cluster, Safe Exit Assist may not properly operate.
- Safe Exit Assist may not properly operate in an area (for example, open

terrain) where any objects are not detected right after the vehicle is turned on, or when the detecting sensor is blocked with foreign material right after the vehicle is turned on.

▲ CAUTION

Turn off Safe Exit Assist to install or remove a trailer, carrier, or another attachment. Turn on Safe Exit Assist when finished.

Limitations of Safe Exit Assist

Safe Exit Assist may not operate properly, or it may operate unexpectedly under the following circumstances:

- Getting out of the vehicle where trees or grass are overgrown
- Getting out of the vehicle where the road is wet
- The approaching vehicle is very fast or very slow

*** NOTICE**

For more details on the limitations of the rear corner radar, refer to "Blind-Spot Collision-Avoidance Assist (BCA) (if equipped)" on page 6-70.

▲ WARNING

- Safe Exit Assist may not operate properly if interfered by strong electromagnetic waves.
- Safe Exit Assist may not operate for 3 seconds after the vehicle is started, or the rear corner radars are initialized.

Manual Speed Limit Assist (MSLA)



- 1 Speed Limit indicator
- 2 Set speed

You can set the speed limit when you do not want to drive over a specific speed. If you drive over the preset speed limit, Manual Speed Limit Assist operates (set speed limit will blink and chime will sound) until the vehicle speed returns within the speed limit.

Manual Speed Limit Assist operation

Setting speed limit

1. Press and hold Driving Assist (DA) button at the desired speed. The Speed Limit (LIMIT) indicator will appear on the cluster.



2. Push the (+) switch up or (-) switch down, and release it at the desired speed. Push the (+) switch up or (-) switch down and hold it. The speed will increase or decrease to the nearest multiple of 10 (multiple of 5 in mph) at first, and then increase or decrease by 10 km/h (5 mph).



3. The set speed limit will be displayed on the cluster.

If you would like to drive over the preset speed limit, depress the accelerator pedal beyond the pressure point to activate the kickdown mechanism. The set speed limit will blink and chime will sound until you return the vehicle speed within the speed limit.



* NOTICE

- When the accelerator pedal is not depressed beyond the pressure point, vehicle speed will maintain within the speed limit.
- A clicking sound may be heard from the kickdown mechanism when the accelerator pedal is depressed beyond the pressure point.

Temporarily pausing Manual Speed Limit Assist



Press the (||) switch to temporarily pause the set speed limit. The set speed limit will turn off but the Speed Limit (LIMIT) indicator will stay on.

Resuming Manual Speed Limit Assist



To resume Manual Speed Limit Assist after the function was paused, operate the (+), (-), (||) switch.

If you push the (+) switch up or (-) switch down, vehicle speed will be set to the current speed on the cluster.

If you press the (||) switch, vehicle speed will resume to the preset speed.

Turning off Manual Speed Limit Assist



Press the Driving Assist (DA) button to turn Manual Speed Limit Assist off. The

Speed Limit (LIMIT) indicator will go off.

WARNING

Take the following precautions when using Manual Speed Limit Assist:

- Always set the vehicle speed under the speed limit in your country.
- Keep Manual Speed Limit Assist off when the function is not in use, to avoid inadvertently setting a speed. Check that the Speed Limit (LIMIT) indicator is off.
- Manual Speed Limit Assist does not substitute for proper and safe driving. It is the responsibility of the driver to always drive safely and should always be aware of unexpected and sudden situations from occurring. Pay attention to the road conditions at all times.

Intelligent Speed Limit Assist (ISLA) (if equipped)

Intelligent Speed Limit Assist uses information from the detected road sign and navigation system to inform the driver of the speed limit and additional information of the current road. Also, Intelligent Speed Limit Assist helps the driver to maintain within the speed limit of the road.

⚠ CAUTION

- Intelligent Speed Limit Assist may not operate properly if the function is used in other countries.
- If a navigation is applied to your vehicle, the navigation needs to be regularly updated for Intelligent Speed Limit Assist to operate properly.

Detecting sensor

Front view camera



Refer to the picture above for the detailed location of the detecting sensor.

⚠ CAUTION

For more details on the precautions of the front view camera, refer to "Forward Collision-Avoidance Assist (FCA) (Front Camera Only) (if equipped)" on page 6-44.

Intelligent Speed Limit Assist settings

Speed limit

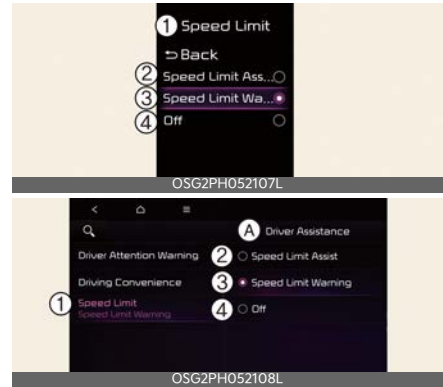

A: Driver Assistance

- 1 Speed Limit
- 2 Speed Limit Assist
- 3 Speed Limit Warning
- 4 Off

With the vehicle on, touch **Settings** → **Driver Assistance** → **Speed Limit** on the instrument cluster or **Settings** → **Vehicle** → **Driver Assistance** → **Speed Limit** on the infotainment system.

- **Speed Limit Assist:** Intelligent Speed Limit Assist will inform the driver of speed limit and additional road signs. In addition, Intelligent Speed Limit Assist will inform the driver to change set speed of Manual Speed Limit Assist or Smart Cruise Control (if equipped) to help the driver stay within the speed limit.
- **Speed Limit Warning:** Intelligent Speed Limit Assist will inform the driver of speed limit and additional road signs. In addition, Intelligent Speed Limit Assist will warn the driver when the vehicle is driven faster than

the speed limit. Manual Speed Limit Assist or Smart Cruise Control (If equipped) set speed will not be automatically adjusted. The driver should adjust the speed manually.

- **Off:** Intelligent Speed Limit Assist will turn off.

Speed limit offset

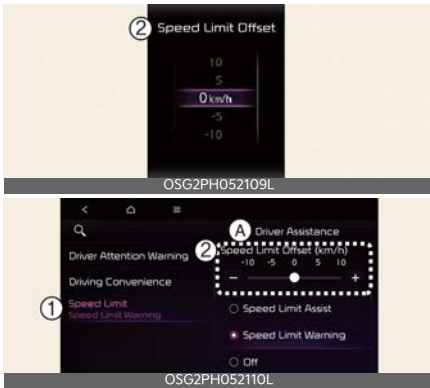

A: Driver Assistance

1 Speed Limit

2 Speed Limit Offset (km/h)

With the vehicle on, touch **Settings** → **Driver Assistance** → **Speed Limit** on the instrument cluster or **Settings** → **Vehicle** → **Driver Assistance** → **Speed Limit** on the infotainment system.

Speed Limit Warning and **Speed Limit Assist** warns the driver when driving speed exceeds the speed at which the set **Speed Limit Offset** is added to the speed limit, or applies the Speed limit offset setting to the detected speed limit.

⚠ WARNING

For your safety, change the settings after parking the vehicle at a safe location.

* NOTICE

- Speed limit and Speed warning function operates based on an offset value added with the speed limit. Set the offset value to '0' to change or warn the speed according to the recognized speed limit.
- The setting of Speed limit offset is not reflected in Navigation-based Smart Cruise Control.
- If you change the Warning volume, the Warning volume of other Driver Assistance systems may change.

Warning volume



A: Driver Assistance

1 Warning Volume

2 Driving Safety Priority

3 High

4 Medium

5 Low

6 Off (If steering wheel vibration is equipped)

With the vehicle on, touch **Settings** → **Driver Assistance** → **Warning Volume** on the instrument cluster or **Settings** → **Vehicle** → **Driver Assistance** → **Warn-**

ing Volume on the infotainment system to change the Warning volume to adjust the Warning volume levels; **High, Medium, Low** or **Off**.

If **Driving Safety Priority** is selected, the audio volume will temporarily decrease to warn the driver with the audible warning for safe driving.

* NOTICE

- If you change the Warning volume, the Warning volume of other Driver Assistance systems may change.
- If **Off** is selected, steering wheel vibration (if equipped) will not turn off.

Intelligent Speed Limit Assist operation

Warning and control

Intelligent Speed Limit Assist is warned and controlled by the following level.

- Displaying speed limit
- Warning overspeed
- Changing set speed

* NOTICE

Intelligent Speed Limit Assist warning and control are described based on the Offset adjust to '0'. For details on Offset setting, refer to "Intelligent Speed Limit Assist settings" on page 6-89.

Displaying speed limit



Speed limit information is displayed on the instrument cluster.

* NOTICE

- If speed limit information of the road cannot be recognized, '---' sign will be displayed. Please refer to "Intelligent Speed Limit Assist malfunction and limitations" on page 6-92 if the road signs are difficult to recognize.
- Intelligent Speed Limit Assist provides additional road sign information in addition to speed limit. The additional road sign information provided may vary according to your country.
- Supplementary sign displayed under the speed limit or overtaking restriction sign means the conditions under which the signs must be followed. If the supplementary sign is not recognized, it is displayed as blank.
- The images and colors in the instrument cluster may differ depending on the cluster type or theme selected from the settings menu.

Warning overspeed



When driving at a speed higher than the displayed speed limit, the red speed limit indicator will be indicated.

Changing set speed



If the speed limit of the road changes during the operation of Manual Speed Limit Assist or Smart Cruise Control, an arrow in the direction of up or down is displayed to inform the driver that the set speed needs to be changed. At this time, the driver can change the set speed according to the speed limit by using the (+) or (-) switch on the steering wheel.

⚠ WARNING

- If the Offset is adjusted over '0', the set speed will change to a higher speed than the speed limit of the road. If you want to drive below the speed limit, adjust the Offset under '0' or use the (-) switch on the steering wheel to lower the set speed.
- Even after changing the set speed according to the speed limit of the road, the vehicle can still be driven over the speed limit. If necessary, depress the brake pedal to reduce your driving speed.
- If the speed limit of the road is under 30 km/h (20 mph), the set speed change function will not work.

- Intelligent Speed Limit Assist operates using the speed unit in the instrument cluster set by the driver. If the speed unit is set to a unit other than the speed unit used in your country, Intelligent Speed Limit Assist may not operate properly.

*** NOTICE**

- For more details on Manual Speed Limit Assist operation, refer to "Manual Speed Limit Assist (MSLA)" on page 6-87.
- For more details on Smart Cruise Control operation, refer to "Smart Cruise Control (SCC) (if equipped)" on page 6-102.

Intelligent Speed Limit Assist malfunction and limitations

Intelligent Speed Limit Assist malfunction

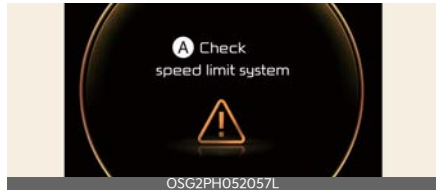

A: Check Speed Limit system

When Intelligent Speed Limit Assist is not working properly, the warning message will appear on the cluster for several seconds, and the master (⚠) warning light will appear on the cluster. If this occurs, we recommend the function checked by an authorized Kia dealer/service partner.

Intelligent Speed Limit Assist disabled

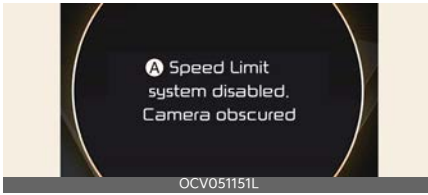

A: Speed limit system disabled. Camera obscured

When the front windshield where the front view camera is located is covered with foreign material, such as snow or rain, it can reduce the detecting performance and temporarily limit or disable Intelligent Speed Limit Assist. If this occurs, the warning message will appear on the cluster.

Intelligent Speed Limit Assist will operate properly when snow, rain or foreign material is removed. Always keep it clean.

If Intelligent Speed Limit Assist does not operate properly after it is removed, we recommend the function checked by an authorized Kia dealer/service partner.

WARNING

Even though the warning message or warning light does not appear on the cluster, Intelligent Speed Limit Assist may not operate properly.

Limitations of Intelligent Speed Limit Assist

Intelligent Speed Limit Assist may not operate properly, or it may operate unexpectedly under the following circumstances:

- The road sign is contaminated or indistinguishable

- The road sign is difficult to see due to bad weather, such as rain, snow, fog, etc.
- The road sign is partially obscured by surrounding objects or shadow
- The road signs do not conform to the standard
 - The text or picture on the road sign is different from the standard
 - The road sign is installed between the main line and the exit road or between diverging roads
 - A sign is attached to another vehicle
- The distance between the vehicle and the road signs is far
- The vehicle encounters appearing road signs
- Intelligent Speed Limit Assist incorrectly recognizes numbers or pictures in the street signs or other signs as the speed limit
- A road sign near the road you are driving is detected
- Multiple signs are installed close together
- The minimum speed limit sign is mis-recognized
- The minimum speed limit sign is on the road
- The brightness changes suddenly, for example when entering or exiting a tunnel or passing under a bridge
- Headlamps are not used or the brightness of the headlamps are weak at night or in the tunnel
- The field of view of the front view camera is obstructed by sun glare
- Road signs are difficult to recognize due to the reflection of sunlight, street lights, or oncoming vehicles

- The navigation information or GPS information contain errors.
- The driver does not follow the guide of the navigation.
- Driving on a road that is sharply curved or continuously curved
- Driving through speed bumps, or driving up and down or left to right on steep inclines
- The vehicle is shaking heavily
- Driving on a newly opened road

⚠ WARNING

- Intelligent Speed Limit Assist is a supplemental function that helps the driver to comply with the speed limit on the road, and may not display the correct speed limit or control the driving speed properly.
- It is the responsibility of the driver to keep the speed limit.

*** NOTICE**

For more details on the limitations of the front view camera, refer to "Forward Collision-Avoidance Assist (FCA) (Front Camera Only) (if equipped)" on page 6-44.

Driver Attention Warning (DAW) (if equipped)

Basic function

Driver Attention Warning can help determine the driver's attention level by analyzing driving pattern and driving time while the vehicle is driven. Driver Attention Warning will recommend a break when the driver's attention level falls below a certain level.

Leading vehicle departure alert function

Leading Vehicle Departure Alert function will inform the driver when a detected vehicle in front departs from a stop.

Detecting sensor

Front view camera



The front view camera is used as a detecting sensor to help detect driving patterns and front vehicle departure while vehicle is being driven. Refer to the picture above for the detailed location of the detecting sensor.

⚠ CAUTION

- Always keep the front view camera in good condition to maintain optimal performance of Driver Attention Warning.

- For more details on the precautions of the front view camera, refer to "Forward Collision-Avoidance Assist (FCA) (Front Camera Only) (if equipped)" on page 6-44.

Driver Attention Warning settings

Driver Attention Warning



A: Driver Assistance

- 1 Driver Attention Warning
- 2 Inattentive Driving Warning

With the vehicle on, touch or deselect **Settings** → **Driver Assistance** → **Driver Attention Warning** on the instrument cluster or select **Settings** → **Vehicle** → **Driver Assistance** → **Driver Attention Warning** on the infotainment system.

- If **Inattentive Driving Warning** is selected, Driver Attention Warning will recommend taking a break when the level falls below a certain level.

* NOTICE

Whenever the engine is turned on, **Inattentive Driving Warning** will always turn on. (For Europe, Russia)

Leading Vehicle Departure Alert



A: Driver Assistance

- 1 Driver Attention Warning
- 2 Leading Vehicle Departure Alert

- If **Leading Vehicle Departure Alert** is selected, the function will inform the driver when a detected vehicle in front departs from a stop.

Driver Attention Warning operation

Basic function

The basic function of Driver Attention Warning is to warn the driver 'Consider taking a break'.

Taking a break

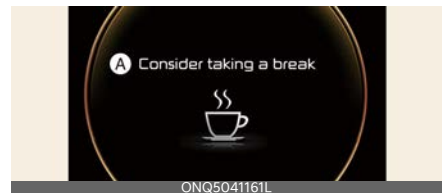

A: Consider taking a break

Warning message will appear on the cluster and an audible warning will sound to suggest that the driver take a break, when the driver's attention level is below a certain level.

- Driver Attention Warning will not suggest a break when the total driving time is shorter than 5 minutes or 10 minutes has not passed after the last break was suggested.

Driver Attention Warning (DAW) operates under the following conditions:

- Your driving speed: Approximately 0~200 km/h (0~120 mph).

⚠ WARNING

For your safety, change the Settings after parking the vehicle at a safe location.

⚠ CAUTION

- Driver Attention Warning may suggest a break depending on the driver's driving pattern or habits, even if the driver doesn't feel fatigue.
- Driver Attention Warning is a supplemental function and may not be able to determine whether the driver is inattentive.
- The driver who feels fatigued should take a break at a safe location, even though there is no break suggestion by Driver Attention Warning.

*** NOTICE**

For more details on vehicle settings, refer to "User settings mode" on page 5-58.

Leading vehicle departure alert function



A: Leading vehicle is driving on

When a detected vehicle in front departs from a stop, Leading Vehicle Departure Alert will inform the driver by displaying the warning message on the cluster and an audible warning will sound.

⚠ WARNING

- If any other system's warning message is displayed or audible warning is generated, Leading Vehicle Departure Alert's warning message may not be displayed and audible warning may not be generated.
- The driver should hold the responsibility to safely drive and control the vehicle.

⚠ CAUTION

- Leading Vehicle Departure Alert is a supplemental function and may not alert the driver whenever the front vehicle departs from a stop.
- Always check the front of the vehicle and road conditions before departure.

*** NOTICE**

The images and colors in the instrument cluster may differ depending on the cluster type or theme selected from the settings menu.

Driver Attention Warning malfunction and limitations

Driver Attention Warning malfunction

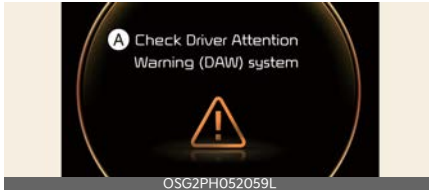

A: Check Driver Attention Warning (DAW) system

When Driver Attention Warning is not working properly, the warning message will appear on the cluster for several seconds, and the master (⚠️) warning light will appear on the cluster. If this occurs, have Driver Attention Warning be inspected by a professional workshop. Kia recommends visiting an authorized Kia dealer/service partner.

Driver Attention Warning disabled

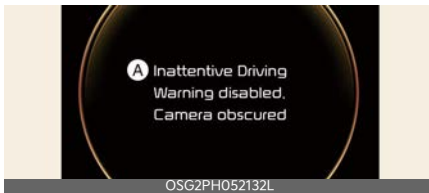

A: Inattentive Driving Warning disabled. Camera obscured

When the front view camera is located is covered with foreign material, such as snow or rain, it can reduce the detecting performance and temporarily limit or disable Driver Attention Warning.

If this occurs the warning message, and the (⚠️) warning light will appear on the cluster. Driver Attention Warning will operate normally when snow, rain or for-

ign material is removed. Always keep it clean.

If Driver Attention Warning does not operate normally after obstruction (snow, rain, or foreign material) is removed, have the vehicle inspected by a professional workshop. Kia recommends visiting an authorized Kia dealer/service partner.

⚠️ WARNING

Driver Attention Warning may not work properly in areas where substances are not detected after turning ON the vehicle (e.g. in open terrain) or if the recognition sensor is contaminated.

Limitations of Driver Attention Warning

Driver Attention Warning may not work properly in the following situations:

- The vehicle is driven violently
- The vehicle intentionally crosses over lanes frequently
- The vehicle is controlled by Driver Assistance system, such as Lane Keeping Assist

Leading vehicle departure alert function

- When the vehicle cuts in

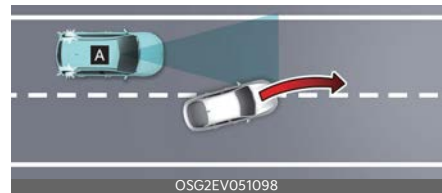



[A]: Your vehicle, [B]: Front vehicle
 If a vehicle cuts in front of your vehicle, Leading Departure Alert may not operate properly.

- When the vehicle ahead sharply steers



[A]: Your vehicle, [B]: Front vehicle
 If the vehicle in front makes a sharp turn, such as to turn left or right or make a U-turn, etc., Leading Vehicle Departure Alert may not operate properly.

- When the vehicle ahead abruptly departs

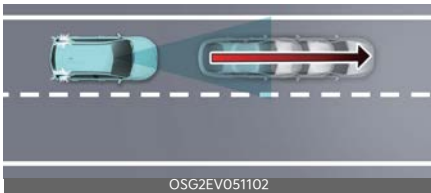

If the vehicle in front abruptly departs, Leading Vehicle Departure Alert may not operate properly.

- When a pedestrian or bicycle is between you and the vehicle ahead



If there is a pedestrian(s) or bicycle(s) in between you and the vehicle in front, Leading Vehicle Departure Alert may not operate properly.

- When in a parking lot

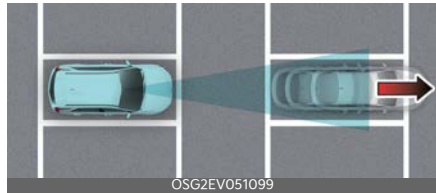

If a vehicle parked in front drives away from you, Leading Vehicle Departure Alert may alert you that the parked vehicle is driving away.

- When driving at a tollgate or intersection, etc.

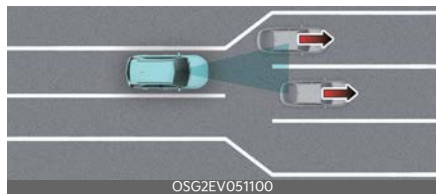

If you pass a tollgate or intersection with lots of vehicles or you drive where lanes are merged or divided frequently, Leading Vehicle Departure Alert may not operate properly.

⚠ WARNING

Driver Attention Warning may not operate for 15 seconds after the vehicle is started, or the front view camera is initialized.

*** NOTICE**

For more details on the precautions of the front view camera, refer to "Forward Collision-Avoidance Assist (FCA) (Front Camera Only) (if equipped)" on page 6-44.

Cruise Control (CC) (if equipped)

- 1 Cruise indicator
- 2 Set speed

Cruise Control will allow you to drive at speeds above 30 km/h (20 mph) without depressing the accelerator pedal.

Cruise Control operation**Setting speed**

1. Accelerate to the desired speed, which must be more than 30 km/h (20 mph).



2. Press the Driving Assist button at the desired speed. The set speed and Cruise (CRUISE) indicator will appear on the cluster.
3. Release the accelerator pedal. Vehicle speed will maintain the set speed even when the accelerator pedal is not depressed.

*** NOTICE**

- The vehicle may slightly slow down or speed up while driving uphill or downhill.
- The Driving Assist button symbol may vary depending on your vehicle option.

Increasing set speed



OSG2H051054

- Push the (+) switch up and release it immediately. The set speed will increase by 1 km/h (1 mph) each time the switch is operated in this manner.
- Push the (+) switch up and hold it while monitoring the set speed on the cluster. The set speed will increase to the nearest multiple of 10 (multiple of 5 in mph) at first, and then increase by 10 km/h (5 mph) each time the switch is operated in this manner. Release the switch when the desired speed is shown and the vehicle will accelerate to that speed.

Decreasing set speed



OSG2H051055

- Push the (-) switch down and release it immediately. The set speed will decrease by 1 km/h (1 mph) each time the switch is operated in this manner.

- Push the (-) switch down and hold it while monitoring the set speed on the cluster. The set speed will decrease to the nearest multiple of 10 (multiple of 5 in mph) at first, and then decrease by 10 km/h (5 mph) each time the switch is operated in this manner. Release the switch at the speed you want to maintain.

Accelerating temporarily

If you want to speed up temporarily when Cruise Control is on, depress the accelerator pedal.

To return to the set speed, take your foot off the accelerator pedal.

If you push the (+) switch up or (-) switch down at increased speed, the set speed will be set to the current increased speed.

Temporarily pausing Cruise Control



OSG2H051056_2

Cruise Control will be paused when:

- Depressing the brake pedal.
- Pressing the (||) switch.
- Shifting the gear to N (Neutral).
- Decreasing vehicle speed to less than approximately 30 km/h (20 mph).
- ESC (Electronic Stability Control) is operating.
- Downshifting to 2nd gear when in Manual Shift mode.

The set speed will turn off but the Cruise (CRUISE) indicator will stay on.

*** NOTICE**

If Cruise Control pauses during a situation that is not mentioned, Kia recommends visiting an authorized Kia dealer/service partner.

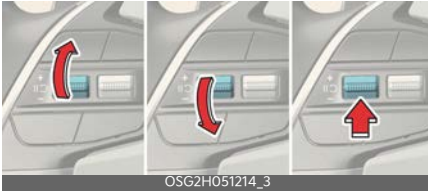
Resuming Cruise Control

Operate the (+), (-) or (↷) switch.

If you push the (+) switch up or (-) switch down, the set speed will be set to the current speed on the cluster.

If you press the (↷) switch, vehicle speed will resume to the preset speed.

The vehicle speed must be above 30 km/h (20 mph) for Cruise Control to resume.

⚠ WARNING

Check the driving condition before using the (↷) switch. Driving speed may sharply increase or decrease when you press the (↷) switch.

Turning off Cruise Control

Press the Driving Assist button to turn Cruise Control off. The Cruise (Ⓢ CRUISE) indicator will go off.

Always press the Driving Assist button to turn Cruise Control off when not in use.

*** NOTICE**

If your vehicle is equipped with Manual Speed Limit Assist, press and hold the Driving Assist button to turn off Cruise Control. However, Manual Speed Limit Assist will turn on.

⚠ WARNING

Take the following precautions when using Cruise Control:

- Always set the vehicle speed under the speed limit in your country.
- Keep Cruise Control off when the function is not in use, to avoid inadvertently setting a speed. Check that the Cruise (Ⓢ CRUISE) indicator is off.
- Cruise Control does not substitute for proper and safe driving. It is the responsibility of the driver to always drive safely and should always be aware of unexpected and sudden situations from occurring.
- Always drive cautiously to prevent unexpected and sudden situations from occurring. Pay attention to the road conditions at all times.
- Do not use Cruise Control when it may be unsafe to keep the vehicle at a constant speed:
 - When driving in heavy traffic, or when traffic conditions make it difficult to drive at a constant speed
 - When driving on rainy, icy, or snow-covered roads
 - When driving on hilly or windy roads
 - When driving in windy areas

- When driving with limited view (possibly due to bad weather, such as fog, snow, rain and sandstorm)
 - Do not use Cruise Control when towing a trailer.
-

Smart Cruise Control (SCC) (if equipped)

Smart Cruise Control is designed to help detect the vehicle ahead and help maintain the desired speed and minimum distance between the vehicle ahead.

Detecting sensor

Front view camera



Front radar



The front view camera and front radar are used as a detecting sensor to detect front vehicles.

Refer to the picture above for the detailed location of the detecting sensor.

▲ CAUTION

Always keep the front view camera and front radar in good condition to maintain optimal performance of Smart Cruise Control.

For more details on the precautions of the front view camera and front radar, refer to "Forward Collision-Avoidance Assist (FCA) (Front Camera Only) (if equipped)" on page 6-44.

Smart Cruise Control settings

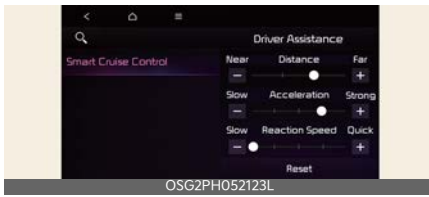

With the vehicle on, touch **Settings** → **Driver Assistance** → **Driving Convenience** → **Smart Cruise Control** on the instrument cluster or **Settings** → **Vehicle** → **Driver Assistance** → **Driving Convenience** → **Smart Cruise Control** on the infotainment system to set the distance, acceleration and the reaction speed.

⚠ CAUTION

When the trailer is connected, Smart Cruise Control automatically turns off (if equipped). In this case, you cannot get help from Smart Cruise Control. Always drive with care.

Warning volume

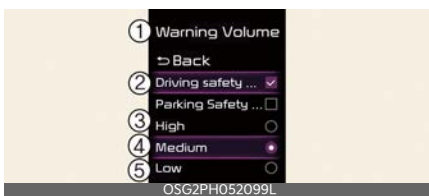

A: **Driver Assistance**

1 **Warning Volume**

2 **Driving Safety Priority**

3 **High**

4 **Medium**

5 **Low**

6 **Off** (If steering wheel vibration function is equipped)

With the vehicle on, touch **Settings** → **Driver Assistance** → **Warning Volume** on the instrument cluster or **Settings** → **Vehicle** → **Driver Assistance** → **Warning Volume** on the infotainment system to change the Warning volume to adjust the Warning volume levels; **High**, **Medium**, **Low** or **Off**.

If **Driving Safety Priority** is selected, the audio volume will temporarily decrease to warn the driver with the audible warning for safe driving.

* NOTICE

- If the vehicle is restarted, Warning Volume will maintain the last setting.
- If you change the Warning Volume, the Warning Volume of other Driver Assistance systems may change.

Smart Cruise Control operation

Operating conditions for basic function

Basic function

Smart Cruise Control operates when the following conditions are satisfied.

- The gear is in D (Drive)
- Your vehicle speed is within the operating speed range
 - 10~200 km/h (5~120 mph): when there is no vehicle in front
 - 0~200 km/h (0~120 mph): when there is a vehicle in front
- ESC (Electronic Stability Control) or ABS is on

- Smart Cruise Control does not operate in the following conditions.
- The driver's door is opened
- Engine RPM is high
- EPB (Electronic Parking Brake) is applied
- ESC (Electronic Stability Control) or ABS is controlling the vehicle
- Forward Collision-Avoidance Assist brake control is operating
- Remote Smart Parking Assist brake control is operating (if equipped)

*** NOTICE**

When stopped behind another vehicle, the driver can turn on Smart Cruise Control while the brake pedal is depressed.

Operating conditions for Acceleration Assist

Overtaking Acceleration Assist will operate when the turn signal indicator is turned on to the left (left-hand drive) or turned on to the right (right-hand drive) while Smart Cruise Control is operating, and the following conditions are satisfied:

- Your driving speed is above 60 km/h (40 mph)
- A vehicle is detected in front of your vehicle

Overtaking Acceleration Assist does not operate in the following conditions.

- The hazard warning flasher is on
- Vehicle speed is reduced to maintain distance with the vehicle in front

▲ WARNING

When the turn signal indicator is turned on to the left (left-hand drive) or turned on to the right (right-hand drive) while there is a vehicle ahead, the vehicle may

accelerate temporarily. Pay attention to the road conditions at all times.

Regardless of your country's driving direction, Overtaking Acceleration Assist will operate when the conditions are satisfied. When using the function in countries with different driving direction, always check the road conditions at all times.

Turning on Smart Cruise Control



Press the Driving Assist button to turn on Smart Cruise Control. The speed will be set to the current speed on the cluster.

- If there is no vehicle in front of you, the set speed will be maintained.
- If there is a vehicle in front of you, the speed may be adjusted to maintain the distance to the vehicle ahead. If the vehicle ahead accelerates, your vehicle will travel at a steady cruising speed after accelerating to the set speed.

*** NOTICE**

- If your vehicle speed is between 0~30 km/h (0~20 mph) when you press the Driving Assist button, the Smart Cruise Control speed will be set to 30 km/h (20 mph).
- If the driver changes to the lower gear, the driving speed may not reach the set speed.

Setting vehicle distance



Each time the button is pressed, the headway changes as follows:

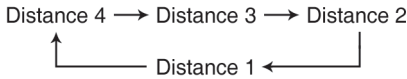

* NOTICE

- If you drive at 90 km/h (56 mph), the distance is maintained as follows:
Distance 4 - approximately 52.5 m (172 ft.)
Distance 3 - approximately 40 m (130 ft.)
Distance 2 - approximately 32.5 m (106 ft.)
Distance 1 - approximately 25 m (82 ft.)
- The distance is set to the last set distance when the vehicle is restarted, or when Smart Cruise Control was temporarily canceled.

Increasing set speed



- Push the (+) switch up and release it immediately. The set speed will increase by 1 km/h (1 mph) each time the switch is operated in this manner.

- Push the (+) switch up and hold it. The set speed will increase by 10 km/h (5 mph) each time the switch is operated in this manner.
You can increase the set speed to 200 km/h (120 mph).

⚠ WARNING

Check the driving condition before using the (+) switch. Driving speed may sharply increase when you push up and hold the (+) switch.

Decreasing set speed



- Push the (-) switch down and release it immediately. The set speed will decrease by 1 km/h (1 mph) each time the switch is operated in this manner.
- Push the (-) switch down and hold it. The set speed will decrease by 10 km/h (5 mph) each time the switch is operated in this manner.
You can decrease the set speed to 30 km/h (20 mph).

Temporarily canceling Smart Cruise Control



Press the (⏏) switch or depress the brake pedal to temporarily cancel Smart Cruise Control.

Resuming Smart Cruise Control

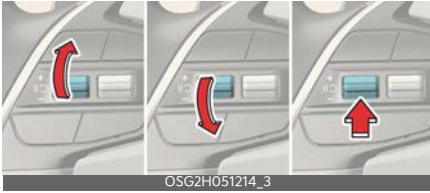

To resume Smart Cruise Control after the function was canceled, operate the (+), (-) or (||) switch.

If you push the (+) switch up or (-) switch down, the set speed will be set to the current speed on the cluster.

If you press the (||) switch, vehicle speed will resume to the preset speed.

WARNING

Check the driving condition before using the (||) switch. Driving speed may sharply increase or decrease when you press the (||) switch.

Turning off Smart Cruise Control



Press the Driving Assist button to turn Smart Cruise Control off.

NOTICE

If your vehicle is equipped with Manual Speed Limit Assist, press and hold the Driving Assist button to turn off Smart Cruise Control. However Manual Speed Limit Assist will turn on.

CAUTION

Do not use the switches and buttons at the same time. Smart Cruise Control may not operate properly.

Displaying operating status

You can see the status of the Smart Cruise Control operation in the Driving Assist view on the cluster. Refer to "LCD display modes" on page 5-54.

Smart Cruise Control will be displayed as below depending on the status of the function.



Smart Cruise Control will be displayed as below depending on the status of the function.

- When operating
 1. Whether there is a vehicle ahead and the selected distance level
 2. Set speed
 3. Whether there is a vehicle ahead and the target vehicle distance
- When temporarily canceled
 1. Vehicle (shaded)
 2. Previous set speed (shaded)

* NOTICE

- The distance of the front vehicle on the cluster is displayed according to the actual distance between your vehicle and the vehicle ahead.
- The target distance may vary according to your driving speed and the set distance level. If your driving speed is low, even though the vehicle distance have changed, the change of the target vehicle distance may be small.
- The images and colors in the instrument cluster may differ depending on the cluster type or theme selected from the settings menu.

Accelerating temporarily

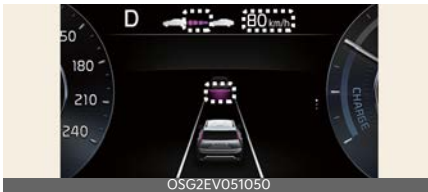

If you want to speed up temporarily without altering the set speed while Smart Cruise Control is operating, depress the accelerator pedal. While the accelerator pedal is depressed, the set speed, distance level and target distance will blink on the cluster.

However, if the accelerator pedal is depressed insufficiently, the vehicle may decelerate.

⚠ WARNING

Be careful when accelerating temporarily, because the speed and distance is not controlled automatically even if there is a vehicle in front of you.

Temporarily canceling Smart Cruise Control



A: SCC (Smart Cruise Control) cancelled

Smart Cruise Control will be temporarily canceled automatically when:

- The vehicle speed is above 210 km/h (130 mph)
- The vehicle is stopped for a certain period of time
- The accelerator pedal is continuously depressed for a certain period of time
- The conditions for the Smart Cruise Control to operate is not satisfied

If Smart Cruise Control is temporarily canceled automatically, the warning message will appear on the cluster, and an audible warning will sound to warn the driver.

* NOTICE

If Smart Cruise Control is temporarily canceled while the vehicle is at a standstill with the function activated, EPB (Electronic Parking Brake) maybe applied.

⚠ WARNING

When Smart Cruise Control is temporarily canceled, distance with the front vehicle will not be maintained. Always have your eyes on the road while driving, and if necessary, depress the brake pedal to reduce your driving speed in order to maintain a safe distance.

Smart Cruise Control conditions not satisfied



A: SCC (Smart Cruise Control) conditions not met

If the Driving Assist button, (+) switch, (-) switch or (⏮) switch is operated when Smart Cruise Control operating conditions are not satisfied, the warning message will appear on the cluster, and an audible warning will sound.

In traffic situation

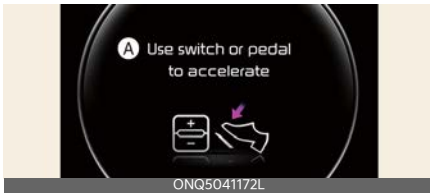

A: Use switch or pedal to accelerate

In traffic, your vehicle will stop if the vehicle ahead of you stops. Also, if the vehicle ahead of you starts moving, your vehicle will start as well. In addition, after the vehicle has stopped and a certain time have passed, the warning message will appear on the cluster. Depress the accelerator pedal or operate the (+) switch, (-) switch or (⏮) switch to start driving.

Warning road conditions ahead



A: Watch for surrounding vehicles

In the following situation, the warning message will appear on the cluster, and an audible warning will sound to warn the driver of road conditions ahead.

⚠ WARNING

Always pay attention to vehicles or objects that may suddenly appear in front of you, and if necessary, depress the brake pedal to reduce your driving speed in order to maintain a safe distance.

Collision warning



A: Collision warning!

While Smart Cruise Control is operating, when the collision risk with the vehicle ahead is high, the warning message will appear on the cluster, and an audible warning will sound to warn the driver. Always have your eyes on the road while driving, and if necessary, depress the brake pedal to reduce your driving speed in order to maintain a safe distance.

⚠ WARNING

In the following situations, Smart Cruise Control may not warn the driver of a collision.

Always pay attention to road and driving conditions while driving.

- The distance from the front vehicle is near, or the vehicle speed of the front vehicle is faster or similar with your vehicle
- The speed of the front vehicle is very slow or is at a standstill
- The accelerator pedal is depressed right after Smart Cruise Control is turned on

⚠ WARNING

- Smart Cruise Control does not substitute for proper and safe driving. It is the responsibility of the driver to always check the speed and distance to the vehicle ahead.
- Smart Cruise Control may not recognize unexpected and sudden situations or complex driving situations, so always pay attention to driving conditions and control your vehicle speed.
- Keep Smart Cruise Control off when the function is not in use to avoid inadvertently setting a speed.
- Do not open the door or leave the vehicle when Smart Cruise Control is operating, even if the vehicle is stopped.
- Always be aware of the selected speed and headway distance.
- Keep a safe distance according to road conditions and vehicle speed. If the headway distance is too close during high-speed driving, a serious collision may result.

- When maintaining distance with the vehicle ahead, if the front vehicle disappears, Smart Cruise Control may suddenly accelerate to the set speed. Always be aware of unexpected and sudden situations from occurring.
- Vehicle speed may decrease on an upward slope and increase on a downward slope.
- Always be aware of situations such as when a vehicle cuts in suddenly.
- When you are towing a trailer or another vehicle, turn off Smart Cruise Control for safety reasons.
- Turn off Smart Cruise Control when your vehicle is being towed.
- Smart Cruise Control may not operate properly if interfered by strong electromagnetic waves.
- Smart Cruise Control may not detect an obstacle in front and lead to a collision. Always look ahead cautiously to prevent unexpected and sudden situations from occurring.
- Vehicles moving in front of you with a frequent lane change may cause a delay in Smart Cruise Control reaction or may cause Smart Cruise Control to react to a vehicle actually in an adjacent lane. Always drive cautiously to prevent unexpected and sudden situations from occurring.
- Always be aware of the surroundings and drive safely, even though a warning message does not appear or an audible warning does not sound.
- If any other system's warning message is displayed or warning sound is generated, Smart Cruise Control warning message may not be displayed and warning sound may not be generated.

- You may not hear the warning sound of Forward Collision-Avoidance Assist if the surrounding is noisy.
- The vehicle manufacturer is not responsible for any traffic violation or accidents caused by the driver.
- Always set the vehicle speed under the speed limit in your country.

*** NOTICE**

- Smart Cruise Control may not operate for a few seconds after the vehicle is restarted or the front view camera or front radar is initialized.
- You may hear a sound when the brake is controlled by Smart Cruise Control.

Smart Cruise Control malfunction and limitations

Smart Cruise Control malfunction

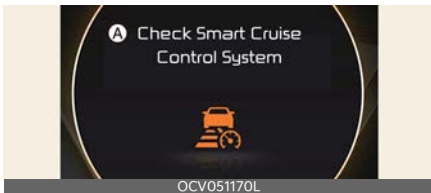

A: Check Smart Cruise Control System

When Smart Cruise Control is not working properly, the warning message will appear, and the (⚠️) warning light will appear on the cluster. Have Smart Cruise Control be inspected by a professional workshop. Kia recommends visiting an authorized Kia dealer/service partner.

Smart Cruise Control disabled

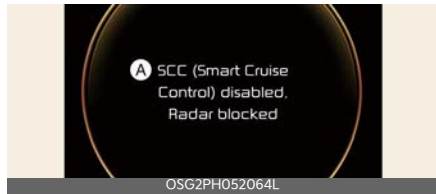

A: SCC (Smart Cruise Control) disabled. Radar blocked

When the front radar cover or sensor is covered with snow, rain, or foreign material, it can reduce the detecting performance and temporarily limit or disable Smart Cruise Control.

If this occurs the warning message will appear for a certain period of time on the cluster.

Smart Cruise Control will operate properly when snow, rain or foreign material is removed.

Always keep it clean.

⚠️ WARNING

Even though the warning message does not appear on the cluster, Smart Cruise Control may not properly operate.

⚠️ CAUTION

Smart Cruise Control may not properly operate in an area (e.g. open terrain), where there is nothing to detect, or detecting sensor is covered in foreign material after turning ON the vehicle.

Limitations of Smart Cruise Control

Smart Cruise Control may not operate properly, or it may operate unexpectedly under the following circumstances:

- The detecting sensor or the surroundings are contaminated or damaged
- Washer fluid is continuously sprayed, or the wiper is on
- The camera lens is contaminated due to tinted, filmed or coated windshield, damaged glass, or sticky foreign material (sticker, bug, etc.) on the glass
- Moisture is not removed or frozen on the windshield
- The field of view of the front view camera is obstructed by sun glare
- Street light or light from an oncoming vehicle is reflected on the wet road surface, such as a puddle on the road
- The temperature around the front view camera is high or low
- An object is placed on the dashboard
- The surrounding is very bright
- The surrounding is very dark, such as in a tunnel, etc.
- The brightness changes suddenly, for example when entering or exiting a tunnel
- The brightness outside is low, and the headlamps are not on or are not bright
- Driving in heavy rain or snow, or thick fog
- Driving through steam, smoke or shadow
- Only part of the vehicle is detected
- The vehicle in front has no tail lights, tail lights are located unusually, etc.
- The brightness outside is low, and the tail lamps are not on or are not bright
- The rear of the front vehicle is small or does not look normal (for example, tilted, overturned, etc.)
- The front vehicle's ground clearance is low or high
- A vehicle suddenly cuts in front
- Your vehicle is being towed
- An object reflecting off the front radar such as a guardrail, nearby vehicle, etc.
- The bumper around the front radar is impacted, damaged or the front radar is out of position
- The temperature around the front radar is high or low
- The vehicle in front is made of material that does not reflect on the front radar
- Driving near a highway (or motorway) interchange or tollgate
- Driving on a slippery surface due to snow, water puddle, ice, etc.
- Driving on a curved road
- The vehicle in front is detected late
- The vehicle in front is suddenly blocked by an obstacle
- The vehicle in front suddenly changes lane or suddenly reduces speed
- The vehicle in front is bent out of shape
- The front vehicle's speed is fast or slow
- With a vehicle in front, your vehicle changes lane suddenly at low speed
- The vehicle in front is covered with snow
- Unstable driving
- You are on a roundabout and the vehicle in front is not detected

- You are continuously driving in a circle
- The adverse road conditions cause excessive vehicle vibrations while driving
- Your vehicle height is low or high due to heavy loads, abnormal tire pressure, etc.
- Driving in following places
 - Driving in a parking lot
 - Driving through a construction area, unpaved road, partial paved road, uneven road, speed bumps, etc.
 - Driving on an incline road, curved road, etc.
 - Driving through a roadside with trees or streetlights
 - Driving through a narrow road where trees or grass are overgrown
 - There is interference by electromagnetic waves, such as driving in an area with strong radio waves or electrical noise
 - Driving on a curved road
- Driving through a tunnel or iron bridge
- Driving near areas containing metal substances, such as a construction zone, railroad, etc.
- Driving in vast areas where there are few vehicles or structures (for example, desert, meadow, suburb, etc.)
 - Driving through steam, smoke or shadow
 - Driving near a highway (or motorway) interchange or tollgate
 - Driving near areas containing metal substances, such as a construction zone, railroad, etc.



On curves, Smart Cruise Control may not detect a vehicle in the same lane, and may accelerate to the set speed. Also, vehicle speed may rapidly decrease when the vehicle ahead is detected suddenly.

Select the appropriate set speed on curves and apply the brake pedal or accelerator pedal according to the road and driving conditions ahead.



Your vehicle speed can be reduced due to a vehicle in the adjacent lane. Check to be sure that the road conditions permit safe operation of Smart Cruise Control and if necessary, depress the brake pedal to reduce your driving speed in order to maintain a safe distance

- Driving on an inclined road



During uphill or downhill driving, the Smart Cruise Control may not detect a moving vehicle in your lane, and cause your vehicle to accelerate to the

set speed. Also, vehicle speed will rapidly decrease when the vehicle ahead is detected suddenly.

Select the appropriate set speed on inclines and apply the brake pedal or accelerator pedal according to the road and driving conditions ahead.

- Changing lanes



[A]: Your vehicle,

[B]: Lane changing vehicle

When a vehicle (B) moves into your lane from an adjacent lane, it cannot be detected by the sensor until it is in the sensor's detection range. Smart Cruise Control may not immediately detect the vehicle when the vehicle changes lanes abruptly. In this case, you must maintain a safe braking distance, and if necessary, depress the brake pedal to reduce your driving speed in order to maintain a safe distance.

- Situations when detecting are limited



In the following cases, some vehicles in your lane cannot be detected by the sensor:

- Vehicles offset to one side
- Slow-moving vehicles or sudden-decelerating vehicles
- Vehicles with higher ground clearance or vehicles carrying loads that stick out of the back of the vehicle
- Vehicles that has the front lifted due to heavy loads
- Vehicles within approximately 2 m (6 ft.) from your vehicle
- Oncoming vehicles
- Stopped vehicles
- Vehicles with small rear profile, such as trailers
- Narrow vehicles, such as motorcycles, bicycles, or powered two-wheelers
- Special vehicles
- Animals and pedestrians



In the following cases, the vehicle in front cannot be detected by the sensor. Always pay attention to the road and driving conditions and drive safely. If necessary, adjust your vehicle speed.

- You are steering your vehicle
- Driving on narrow or sharply curved roads



- When a vehicle ahead disappears at an intersection, your vehicle may accelerate.

Always pay attention to road and driving conditions while driving.

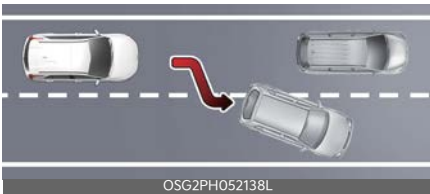

- When a vehicle in front of you merges out of the lane, Smart Cruise Control may not immediately detect the new vehicle that is now in front of you.

Always pay attention to road and driving conditions while driving.



- Always look out for pedestrians when your vehicle is maintaining a distance with the vehicle ahead.

Navigation-based Smart Cruise Control (NSCC) (if equipped)

Navigation-based Smart Cruise Control can help drive at a certain speed according to the road conditions when driving on highways (or motorways) by using road information from the navigation system while Smart Cruise Control is operating.

* NOTICE

- Navigation-based Smart Cruise Control is available only on controlled access road of certain highways.
 - * Controlled access road indicates roads with limited entrances and exits that allow uninterrupted high speed traffic flow. Only passenger cars and motorcycles are allowed on controlled access roads.
- Additional highways may be expanded by future navigation updates.

* NOTICE

Navigation-based Smart Cruise Control operates on main roads of highways (or motorways), and does not operate on interchanges or junctions.

Highway Curve Zone Auto Slowdown

If vehicle speed is high, Highway Curve Zone Auto Slowdown function will temporarily decelerate your vehicle or limit acceleration to help you drive safely on a curve based on the curve information from the navigation.

Highway Set Speed Auto Change

Highway Set Speed Auto Change function automatically changes Smart Cruise Control set speed based on the speed limit information from the navigation.

Navigation-based Smart Cruise Control settings

Highway Auto Speed Change



A: Driver Assistance

1 Driving Convenience

2 Auto Motorway Speed Change

With the vehicle on, touch **Settings** → **Vehicle** → **Driver Assistance** → **Driving convenience** → **Auto Motorway Speed Change** on the infotainment system.

⚠ CAUTION

When the trailer is connected, Navigation-based Smart Cruise Control automatically turns off (if equipped). In this case, you cannot get help from Navigation-based Smart Cruise Control. Always drive with care.

* NOTICE

When there is a problem with Navigation-based Smart Cruise Control, the function cannot be set from the Settings menu.

Navigation-based Smart Cruise Control operation

Operating conditions

Navigation-based Smart Cruise Control is ready to operate if all of the following conditions are satisfied:

- Smart Cruise Control is operating
- Driving on main roads of highways (or motorways)

* NOTICE

For more details on how to operate Smart Cruise Control, refer to "Smart Cruise Control (SCC) (if equipped)" on page 6-102.

Navigation-based Smart Cruise Control display and control

When Navigation-based Smart Cruise Control operates, it will be displayed on the cluster as follows:

Navigation-based Smart Cruise Control standby



If the operating conditions are satisfied, the white (NAV) symbol will appear.

Navigation-based Smart Cruise Control operating



If temporary deceleration is required in the standby state and Navigation-based Smart Cruise Control is operating, the green (NAV) symbol will appear on the cluster.

If the Highway Set Speed Auto Change function operates, the (NAV) symbol and set speed will appear in green on the cluster, and an audible warning will sound.

⚠ WARNING



A: Drive carefully

The warning message will appear in the following circumstances:

- Navigation-based Smart Cruise Control is not able to slow down your vehicle to a safe speed

* NOTICE

- Highway Curve Zone Auto Slowdown and Highway Set Speed Auto Change function uses the same (NAV) symbol.
- The images and colors in the instrument cluster may differ depending on

the cluster type or theme selected from the settings menu.

Highway Curve Zone Auto Slowdown

- Depending on the curve ahead on the highway (or motorway), the vehicle will decelerate, and after passing the curve, the vehicle will accelerate to Smart Cruise Control set speed.
- Vehicle deceleration time may differ depending on the vehicle speed and the degree of the curve on the road. The higher the driving speed, deceleration will start faster.

Highway Set Speed Auto Change

- Highway Set Speed Auto Change function will operate when Smart Cruise Control set speed and the highway (or motorway) speed limit is matched.
- While Highway Set Speed Auto Change function is operating, when the highway (or motorway), speed limit changes, Smart Cruise Control set speed automatically changes to the changed speed limit.
- If Highway Set Speed Auto Change function has changed to the standby state by driving on a road other than the highway (or motorway) main road, Highway Set Speed Auto Change function will operate again when you drive on the main road again without setting the set speed.
- If Highway Set Speed Auto Change function has changed to the standby state by depressing the brake pedal or pressing the (⏏) switch on the steering wheel, press the (⏏) switch to restart the function.

*** NOTICE**

- If Smart Cruise Control set speed is adjusted different from the speed limit, Highway Set Speed Auto Change function will be in the standby state.
- Highway Set Speed Auto Change function only operates based on the speed limits of the highway (or motorway), it does not work with the speed cameras.
- Highway Set Speed Auto Change function does not operate on highway interchanges or junctions.
- When Highway Set Speed Auto Change function is operating, the vehicle automatically accelerates or decelerates when the highway (or motorway) speed limit changes.
- If the speed limit is higher than the speed limit of the speed camera, the audible warning may sound.
- The maximum set speed for Highway Set Speed Auto Change function is 140 km/h (90 mph).
- If the speed limit of a new road is not updated in the navigation, Highway Set Speed Auto Change function may not operate properly.
- If the speed unit is set to a unit other than the speed unit used in your country, Highway Set Speed Auto Change function may not operate properly.

Limitations of Navigation-based Smart Cruise Control

Navigation-based Smart Cruise Control may not operate properly under the following circumstances:

- The navigation is not working properly

- Speed limit and road information in the navigation is not updated
- Map information is not transmitted due to infotainment system's abnormal operation
- The map information and the actual road is different because of real-time GPS data or map information error
- The navigation searches for a route while driving
- GPS signals are blocked in areas such as a tunnel
- A road that divides into two or more roads and joins again
- The driver goes off course the route set in the navigation
- The route to the destination is changed or canceled by resetting the navigation
- The vehicle enters a service station or rest area
- Android Auto or Car Play is operating
- The navigation cannot detect the current vehicle position (for example, elevated roads including overpass adjacent to general roads or nearby roads exist in a parallel way)
- The navigation is being updated while driving
- The navigation is being restarted while driving
- The speed limit of some sections changes according to the road situations
- Driving on a road under construction
- Driving on a road that is controlled
- There is bad weather, such as heavy rain, heavy snow, etc.
- Driving on a road that is sharply curved

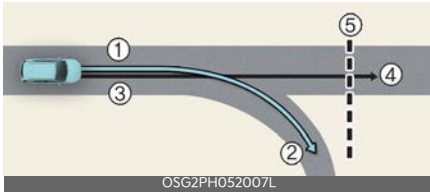

[1]: Set route, [2]: Branch line, [3]: Driving route, [4]: Main road, [5]: Curved road section

- When there is a difference between the navigation set route (branch line) and the driving route (main road), Highway Curve Zone Auto Slowdown function may not operate until the driving route is recognized as the main road.
- When the vehicle's driving route is recognized as the main road by maintaining the main road instead of the navigation set route, Highway Curve Zone Auto Slowdown function will operate. Depending on the distance to the curve and the current vehicle speed, vehicle deceleration may not be sufficient or may decelerate rapidly.

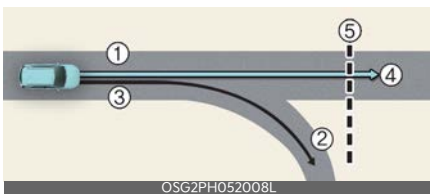

[1]: Main road, [2]: Branch line, [3]: Driving route, [4]: Set route, [5]: Curved road section

- When there is a difference between the navigation route (main road) and the driving route (branch line), Highway Curve Zone Auto Slowdown function will operate based on the curve information on the main road.

- When it is judged that you are driving out of the route by entering the highway interchange or junction, Highway Curve Zone Auto Slowdown function will not operate.

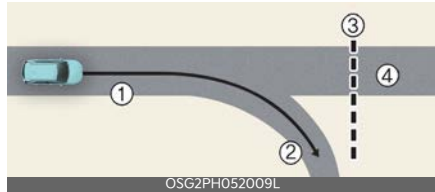

[1]: Driving route, [2]: Branch line, [3]: Curved road section, [4]: Main road

- If there is no destination set on the navigation, Highway Curve Zone Auto Slowdown function will operate based on the curve information on the main road.
- Even if you depart from the main road, Highway Curve Zone Auto Slowdown function may temporarily operate due to navigation information of the highway curve section.

⚠ WARNING

- Navigation-based Smart Cruise Control is not a substitute for safe driving practices, but a convenience function. Always have your eyes on the road, and it is the responsibility of the driver to avoid violating traffic laws.
- The navigation's speed limit information may differ from the actual speed limit information on the road. It is the driver's responsibility to check the speed limit on the actual driving road or lane.
- Navigation-based Smart Cruise Control will automatically be canceled when you leave the highway (or motorway) main road. Always pay attention to road and driving conditions while driving.

- Navigation-based Smart Cruise Control may not operate due to the existence of leading vehicles and the driving conditions of the vehicle. Always pay attention to road and driving conditions while driving.
 - When you are towing a trailer or another vehicle, turn off Navigation-based Smart Cruise Control for safety reasons.
 - After you pass through a tollgate on a highway (or motorway), Navigation-based Smart Cruise Control will operate based on the first lane. If you enter one of the other lanes, Navigation-based Smart Cruise Control might not operate properly.
 - The vehicle will accelerate if the driver depresses the accelerator pedal while Navigation-based Smart Cruise Control is operating, and the function will not decelerate the vehicle. However, if the accelerator pedal is depressed insufficiently, the vehicle may decelerate.
 - If the driver accelerates and releases the accelerator pedal while Navigation-based Smart Cruise Control is operating, the vehicle may not decelerate sufficiently or may rapidly decelerate to a safe speed.
 - If the curve is too large or too small, Navigation-based Smart Cruise Control may not operate.
 - Even if you are driving at a speed lower than Smart Cruise Control set speed, acceleration may be limited by the curve sections ahead.
 - If Navigation-based Smart Cruise Control is operating while leaving the main road to enter an interchange, junction, rest area, etc., the function may operate for a certain period of time.
 - Deceleration by Navigation-based Smart Cruise Control may feel it is not sufficient due to road conditions such as uneven road surfaces, narrow lanes, etc.
-

* NOTICE

- A time gap could occur between the navigation's guidance and when Navigation-based Smart Cruise Control operation starts and ends.
- The speed information on the cluster and navigation may differ.

Lane Following Assist (LFA) (if equipped)

Lane Following Assist is designed to help detect lane markings and/or vehicles on the road, and assists the driver's steering to help center the vehicle in the lane.

Detecting sensor

Front view camera



The front view camera is used as a detecting sensor to detect lane markings and front vehicles.

Refer to the picture above for the detailed location of the detecting sensor.

⚠ CAUTION

For more details on the precautions of the front view camera, refer to "Forward Collision-Avoidance Assist (FCA) (Front Camera Only) (if equipped)" on page 6-44.

Lane Following Assist settings

Warning volume

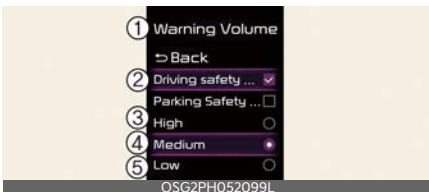

A: Driver Assistance

- 1 Warning Volume
- 2 Driving Safety Priority
- 3 High
- 4 Medium
- 5 Low
- 6 Off (If steering wheel vibration function is equipped)

With the vehicle on, touch **Settings** → **Driver Assistance** → **Warning Volume** on the instrument cluster or **Settings** → **Vehicle** → **Driver Assistance** → **Warning Volume** on the infotainment system to change the Warning volume to adjust the Warning volume levels; **High**, **Medium**, **Low** or **Off**.

If **Driving Safety Priority** is selected, the audio volume will temporarily decrease to warn the driver with the audible warning for safe driving.

⚠ CAUTION

When the trailer is connected, Lane Following Assist automatically turns off (if equipped). In this case, you cannot get help from Lane Following Assist. Always drive with care.

* NOTICE

- When the vehicle is restarted, Lane Following Assist settings will retain its settings.
- If you change the Warning Volume, the Warning Volume of other Driver Assistance systems may change.

- If 'Off' is selected, the Hands-off Warning Volume will not turn off, but the volume will sound as 'Low'.

Lane Following Assist operation

Turning Lane Following Assist On/Off



With the engine on, shortly press the Lane Driving Assist button located on the steering wheel to turn on Lane Following Assist. The grey or green (LFA) indicator light will appear on the cluster. Press the button again to turn off the function.

Lane Following Assist



If the vehicle ahead and/or both lane markings are detected and The vehicle speed is below 160 km/h (90 mph), the green (LFA) indicator light appears on the cluster, and Lane Following Assist helps center the vehicle in the lane by assisting the steering wheel.

CAUTION

When the steering wheel is not assisted, the white (LFA) indicator light blinks and change to grey.

Hands-off warning



A: Keep hands on steering wheel

If the driver takes their hands off the steering wheel for several seconds, the warning message will appear and an audible warning will sound in stages.

- First stage: Warning message
- Second stage: Warning message (red steering wheel) and audible warning

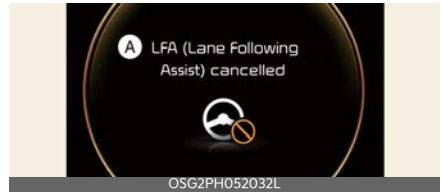

A: LFA (Lane Following Assist) cancelled

If the driver still does not have their hands on the steering wheel after the hands-off warning the warning message will appear and Lane Following Assist will be automatically canceled.

WARNING

- The steering wheel may not be assisted if the steering wheel is held very tight or the steering wheel is steered over a certain degree.
- Lane Following Assist does not operate at all times. It is the responsibility of the driver to safely steer the vehicle and to maintain the vehicle in its lane.
- The hands-off warning message may appear late depending on road condi-

tions. Always have your hands on the steering wheel while driving.

- If the steering wheel is held very lightly the hands-off warning message may appear because Lane Following Assist may not recognize that the driver has their hands on the steering wheel.
- If you attach objects to the steering wheel, the hands-off warning may not work properly.

*** NOTICE**

- For more details on Smart Cruise Control operation, refer to "Smart Cruise Control (SCC) (if equipped)" on page 6-102.
- When both lane markings are detected, the lane lines on the cluster will change from grey to white.

Lane undetected



Lane detected



- The images and colors in the instrument cluster may differ depending on the cluster type or theme selected from the settings menu.
- If lane markings are not detected, steering wheel control by Lane Fol-

lowing Assist can be limited depending on whether a vehicle is in front or the driving conditions of the vehicle.

- Even though the steering is assisted by Lane Following Assist, the driver may control the steering wheel.
- The steering wheel may feel heavier or lighter when the steering wheel is assisted by Lane Following Assist than when it is not.

Lane Following Assist malfunction and limitations

Lane Following Assist malfunction

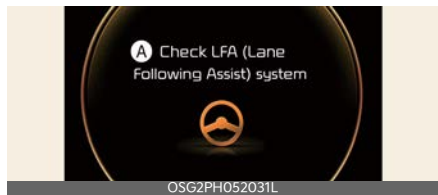

A: Check LFA (Lane Following Assist) system

When Lane Following Assist is not working properly, the warning message will appear and the master warning light (ⓘ) will appear on the cluster.

If this occurs, have Lane Following Assist be inspected by a professional workshop. Kia recommends visiting an authorized Kia dealer/service partner.

Limitations of Lane Following Assist

For more details on Lane Following Assist limitations, refer to "Lane Keeping Assist (LKA) (if equipped)" on page 6-65.

Highway Driving Assist (HDA) (if equipped)

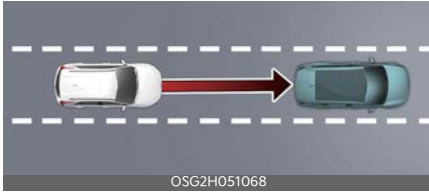

Highway Driving Assist is designed to help detect vehicles and lanes ahead, and help maintain distance from the vehicle ahead, maintain the set speed, help center the vehicle in the lane while driving on the highway (or motorway).

* NOTICE

- Highway Driving Assist is available only on controlled access road of certain highways.
 - * Controlled access road indicates roads with limited entrances and exits that allow uninterrupted high speed traffic flow. Only passenger cars and motorcycles are allowed on controlled access roads.
- Additional highways may be expanded by future navigation updates.

Highway Driving Assist operates on main roads of highways (or motorways), and does not operate on interchanges or junctions.

Detecting sensor

Front view camera



Front radar



Refer to the picture above for the detailed location of the detecting sensors.

⚠ CAUTION

For more details on the precautions of the detecting sensors, refer to "Forward Collision-Avoidance Assist (FCA) (Sensor Fusion) (if equipped)" on page 6-53.

6

Highway Driving Assist settings

Highway Driving Assist



A: Driver Assistance

1 Driving Convenience

2 Highway Driving Assist

With the vehicle on, touch **Settings** → **Driver Assistance** → **Driving Conve-**

nience → **Highway Driving Assist** on the instrument cluster or **Settings** → **Vehicle** → **Driver Assistance** → **Driving Convenience** → **Highway Driving Assist** on the infotainment system.

If **Highway Driving Assist** is selected, it helps maintain distance from the vehicle ahead, maintain the set speed, and helps center the vehicle in the lane.

⚠ WARNING

For your safety, change the Settings after parking the vehicle at a safe location.

⚠ CAUTION

When the trailer is connected, Highway Driving Assist automatically turns off (if equipped). In this case, you cannot get help from Highway Driving Assist. Always drive with care.

*** NOTICE**

- If there is a problem with the functions, the settings cannot be changed. Have the function be inspected by an authorized Kia dealer/service partner.
- If the vehicle is restarted, the functions will maintain the last setting.

Warning volume



- A: **Driver Assistance**
- 1 **Warning Volume**
- 2 **Driving Safety Priority**

- 3 **High**
- 4 **Medium**
- 5 **Low**

6 **Off** (If steering wheel vibration function is equipped)

With the vehicle on, touch **Settings** → **Vehicle** → **Driver Assistance** → **Warning Volume** on the infotainment system to change the Warning volume to adjust the Warning volume levels; **High**, **Medium**, **Low** or **Off**.

If **Driving Safety Priority** is selected, the audio volume will temporarily decrease to warn the driver with the audible warning for safe driving.

*** NOTICE**

- If Off is selected, the Hands-off Warning Volume will not turn off, but the volume will sound as Low.
- If you change the Warning volume, the Warning volume of other Driver Assistance systems may change.

Highway Driving Assist operation

Displaying operating status

You can see the status of the Highway Driving Assist operation in the Driving Assist view on the cluster. Refer to "LCD display modes" on page 5-54.

Operating State

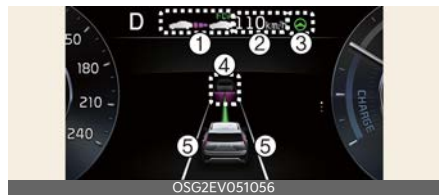

Standby State



Highway Driving Assist will be displayed as below depending on the status of the function.

- 1 Highway Driving Assist indicator, whether there is a vehicle ahead and the selected distance level are displayed.
 - Highway Driving Assist indicator
 - Green (🚗): Operating state
 - Grey (🚗): Standby state
 - White (🚗) blink: Accelerator depressed state
- 2 Set speed
- 3 Lane Following Assist indicator
- 4 Whether there is a vehicle ahead and the selected headway
- 5 Whether the lane is detected or not

*** NOTICE**

- For more details on the display refer to "Smart Cruise Control (SCC) (if equipped)" on page 6-102.
- For more details on the display, refer to "Lane Following Assist (LFA) (if equipped)" on page 6-120.
- The images and colors in the instrument cluster may differ depending on the cluster type or theme selected from the settings menu.

Highway Driving Assist operating

Highway Driving Assist operates when:

- When driving on available road, press Drive Assist button to turn on Highway Driving Assist.
- When entering the main roads of highways (or motorways) while Smart Cruise Control is operating, Driving Assist will not turn on if Lane Following Assist is turned off.

Restarting after stopping

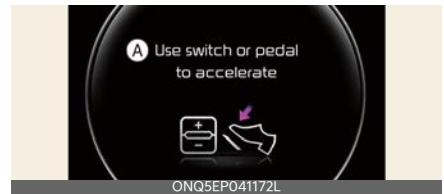

A: Use switch or pedal to accelerate

When Highway Driving Assist is operating, your vehicle will stop if the vehicle ahead of you stops. Also, if the vehicle ahead of you starts moving within 30 seconds after the stop, your vehicle will start as well. In addition, after the vehicle has stopped and 30 seconds have passed, the message will appear on the cluster. Depress the accelerator pedal or operate the + switch, - switch or switch to start driving.

Hands-off warning

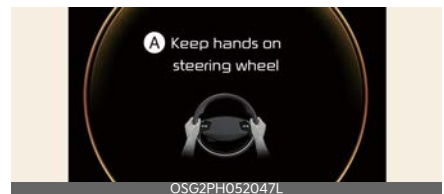

A: Keep hands on steering wheel

If the driver takes their hands off the steering wheel for several seconds, the 'Keep hands on the steering wheel'

warning message will appear and an audible warning will sound in stages.

- First stage: Warning message
- Second stage: Warning message (red steering wheel) and audible warning



A: Highway Driving Assist (HDA) system cancelled

If the driver still does not have their hands on the steering wheel after the hands-off warning, warning message will appear and Highway Driving Assist will be automatically canceled.

Driving speed limit

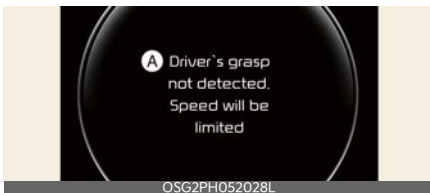

A: Driver's grasp not detected. Driving speed will be limited

When Highway Driving Assist is canceled by the hands-off warning, The driving speed will be limited.

While Driving Speed Limit function is operating, the warning message will appear on the cluster, and an audible warning will sound continuously.

Highway Driving Assist standby

When the Smart Cruise Control is temporarily canceled while Highway Driving Assist is operating, Highway Driving Assist will be in the standby state. At this

time, Lane Following Assist will operate properly.

*** NOTICE**

- Driving Speed Limit helps you drive below 60 km/h (40 mph). At this time, the vehicle decelerates due to the vehicle ahead. After the vehicle has decelerated, it cannot automatically accelerate.
- Driving Speed Limit will cancel in the following circumstances:
 - When the driver grabs the steering wheel again
 - When the driver turns on Lane Following Assist by pressing the Lane Driving Assist button
 - When (+), (-), (⏪) switch or (🚗) button is operated, or the accelerator pedal or the brake pedal is depressed

Highway Driving Assist malfunction and limitations

Highway Driving Assist malfunction



A: Check HDA (Motorway Driving Assist) system

When Highway Driving Assist is not working properly, the warning message will appear, and the (⚠️) warning light will appear on the cluster. Have Highway Driving Assist be inspected by a professional workshop. Kia recommends visit-

ing an authorized Kia dealer/service partner.

WARNING

- The driver is responsible for controlling the vehicle for safe driving.
- Always have your hands on the steering wheel while driving.
- Highway Driving Assist is a supplemental function that assists the driver in driving the vehicle and is not a complete autonomous driving system. Always check road conditions, and if necessary, take appropriate actions to drive safely.
- Always have your eyes on the road, and it is the responsibility of the driver to avoid violating traffic laws. The vehicle manufacturer is not responsible for any traffic violation or accidents caused by the driver.
- Highway Driving Assist may not be able to recognize all traffic situations. Highway Driving Assist may not detect possible collisions due to limitations of the function. Always be aware of the limitations of the function. Obstacles such as vehicles, motorcycles, bicycles, pedestrians, or unspecified objects or structures such as guardrails, tollgate, etc., that may collide with the vehicle may not be detected.
- Highway Driving Assist will turn off automatically under the following situations:
 - Driving on roads that Highway Driving Assist does not operate, such as a rest area, intersection, junction, etc.
 - The navigation does not operate properly such as when the navigation is being updated or restarted
- Highway Driving Assist may inadvertently operate or turn off depending on road conditions (navigation information) and surroundings.
- Lane Following Assist function may be temporarily disabled when the front view camera cannot detect lanes properly or the hands-off warning is on.
- You may not hear the warning sound of Highway Driving Assist if the surrounding is noisy.
- If the vehicle is driven at high speed above a certain speed at a curve, your vehicle may drive to one side or may depart from the driving lane.
- When you are towing a trailer or another vehicle, turn off Highway Driving Assist for safety reasons.
- The hands-off warning message may appear early or late depending on how the steering wheel is held or road conditions. Always have your hands on the steering wheel while driving.
- For your safety, please read the owner's manual before using the Highway Driving Assist.
- Highway Driving Assist will not operate when the vehicle is started, or when the detecting sensors or navigation is being initialized.

Limitations of Highway Driving Assist

Highway Driving Assist may not operate properly, or it may not operate under the following circumstances:

- The map information and the actual road is different because the navigation is not updated
- The map information and the actual road is different because of real-time GPS data or map information error
- The infotainment system is overloaded by simultaneously performing functions such as route search, video playback, voice recognition, etc.
- GPS signals are blocked in areas such as a tunnel
- The driver goes off course, or resetting the navigation route by changing the destination (including route change according to real-time road traffic information), or canceling the route to the destination
- The vehicle enters a service station or rest area
- Android Auto or Car Play is operating
- The navigation cannot detect the current vehicle position (for example, elevated roads including overpass adjacent to general roads or nearby roads exist in a parallel way)

*** NOTICE**

For more details on the limitations of the front view camera and front radar, refer to "Forward Collision-Avoidance Assist (FCA) (Sensor Fusion) (if equipped)" on page 6-53.

Rear View Monitor (RVM) (if equipped)

Rear View Monitor shows the area behind the vehicle to assist you when parking or backing up.

Detecting sensor

Rear view camera



Refer to the picture above for the detailed location of the detecting sensor.

Rear View Monitor settings

Warning volume



A: Driver Assistance

1 Warning Volume

2 Parking Safety Priority

If **Parking Safety Priority** is selected, the audio volume will temporarily decrease while Rear View Monitor is operating for safe parking.

*** NOTICE**

If you change the Warning volume, the Warning volume of other Driver Assistance systems may change.

Camera settings

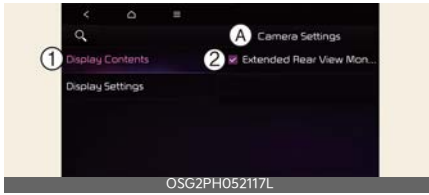

A: Camera Settings

1 Display Contents

2 Display Settings

You can change Rear View Monitor 'Display Contents' by touching the setup icon (⚙️) on the screen while Rear View Monitor is operating, or touching **Settings** → **Vehicle** → **Driver assistance** → **Parking safety** → **Camera settings** on the infotainment system

- **Display Contents:** To change the settings of Rear view parking guide and Extended rear camera use.
- **Display Settings:** To change the screen's brightness and contrast.

* NOTICE

The settings menu may not be depending on the specifications of the vehicle specifications.

Rear View Parking Guide

Rear View Parking Guide Lines



If **Rear View Parking Guide Lines** is selected, the rear view parking guide

lines will be displayed at the left side of the infotainment system screen.

* NOTICE

The horizontal guideline shows the distance of 0.5 m (1.6 ft.), 1 m (3.3 ft.) and 2.3 m (7.6 ft.) from the vehicle.

Top View Parking Guide Lines



If **Rear View Parking Guide Lines** is selected, the top view parking guide lines will be displayed at the left side of the infotainment system screen.

* NOTICE

The horizontal scale of rear top view parking guide indicates the tailgate opening distance, 1.5 m from the vehicle.

Extended rear camera use

With the vehicle on, touch **Settings** → **Vehicle** → **Driver assistance** → **Parking safety** → **Camera settings** → **Display contents** → **Extend rear camera use** on the infotainment system to turn on Extended Rear View function and deselect to turn off the function.

Rear View Monitor operation

Parking/View button

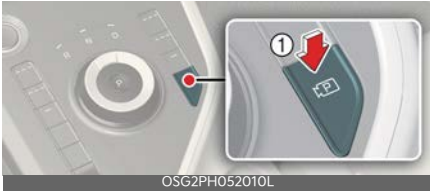

Press the Parking/View button (1) to turn on Rear View Monitor.

Press the button again to turn off the function.

Rear view function



Operating conditions

Rear View Monitor will turn on when the following conditions are satisfied:

- Shifting the gear to R (Reverse).
- Pressing the Parking/View button (1) while P (Park) gear position is selected
- Pressing the View icon with the Rear top view on the screen

Off conditions

Rear View Monitor will turn off when the following conditions are satisfied:

- Pressing the Parking/View button (1) again while P (Park) gear position is selected, with the rear view on the screen.
- Changing the gear from R (Reverse) to P (Park).

* NOTICE

Rear View Monitor will not turn off when the vehicle is in R (Reverse).

Extended Rear View Monitor

Extended Rear View Monitor function maintains the rear view of the vehicle when shifting the gear from R (Reverse) to N (Neutral) or D (Drive) to help you park safely.

Operating conditions

Rear View Monitor will maintain when the following conditions are satisfied:

- Shifting the gear from R (Reverse) to N (Neutral) or D (Drive).
- The vehicle speed is below approximately 10 km/h (6 mph).

Off conditions

Extended Rear View Monitor function will turn off when one the following conditions are satisfied:

- The vehicle speed is above approximately 10 km/h (6 mph).
- Pressing the Parking/View button (1).
- Shifting the gear to P (Park).

Rear View while driving



The driver is able to check the rear view on the screen while driving, it is to assist with safe driving.

Operating conditions

Rear View while driving will turn on under the following conditions:

- The Parking/View button (1) is pressed, while the gear is in N (Neutral) or D (Drive).

Off conditions

Rear View while driving will turn off under the following conditions:

- The gear is shifted to P (Park).
- The Parking/View button is pressed or the infotainment system button is pressed.

Rear Top View



Rear Top View shows the rear top view of your vehicle when parking for you to check the distance between an object and behind the vehicle.

Rear Top View will turn on under the following conditions:

- The gear is shifted to R (Reverse) and the icon is selected among the view buttons.
- The Parking/View button is pressed, while the gear is in P (Park), N (Neutral) or D (Drive), and vehicle speed is 10 km/h (6 mph) or less.

Rear View Monitor malfunction and limitations

Rear View Monitor malfunction

When Rear View Monitor is not working properly, or the screen flickers, or the camera image does not display properly, Kia recommends visiting an authorized Kia dealer/service partner.

Limitations of Rear View Monitor

When the vehicle is stopped for a long time in winter or when the vehicle is parked in an indoor parking lot, the exhaust fumes may temporarily blur the image.

⚠ WARNING

- The rear view camera does not cover the complete area behind the vehicle. The driver should always check the rear area directly through the inside and outside rearview mirror before parking or backing up.
- The image shown on the screen may differ from the actual distance of the object. Make sure to directly check the vehicle's surroundings for safety.
- Always keep the rear view camera lens clean. If the lens is covered with foreign material, it may adversely affect camera performance and Rear View Monitor may not operate properly. However, do not use chemical solvents such as strong detergents containing high alkaline or volatile organic solvents (gasoline, acetone etc.). This may damage the camera lens.

Rear Cross-Traffic Collision-Avoidance Assist (RCCA) (if equipped)

Rear Cross-Traffic Collision-Avoidance Assist is designed to help detect vehicles approaching from the left and right side while your vehicle is reversing, and warn the driver that a collision is imminent with a warning message and an audible warning. Also, braking is assisted to help prevent collision.

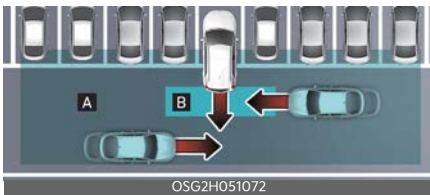

[A]: Rear Cross-Traffic Collision Warning operating range

[B]: Rear Cross-Traffic Collision-Avoidance Assist operating range

⚠ CAUTION

Warning timing may vary depending on vehicle speed of the approaching vehicle.

Detecting sensor

Rear corner radar



Refer to the picture above for the detailed location of the detecting sensors.

* NOTICE

For more details on the precautions of the rear corner radar, refer to "Blind-Spot Collision-Avoidance Assist (BCA) (if equipped)" on page 6-70.

Rear Cross-Traffic Collision-Avoidance Assist settings

Rear Cross-Traffic Safety

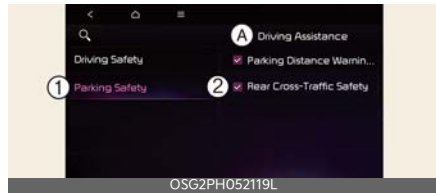
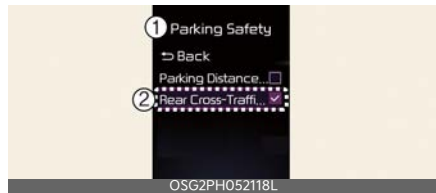

A: Driver Assistance

1 Parking Safety

2 Rear Cross-Traffic Safety

With the vehicle on, touch **Settings** → **Driver Assistance** → **Parking Safety** → **Rear Cross-Traffic Safety** from the User settings menu or select **Settings** → **Vehicle** → **Driver Assistance** → **Parking Safety** → **Rear Cross-Traffic Safety** on the infotainment system screen to turn on Rear Cross-Traffic Collision-Avoidance Assist.

⚠ WARNING

When the engine is restarted, Rear Cross-Traffic Collision-Avoidance Assist will always turn on. However, if **Rear Cross-Traffic Safety** is deselected after the vehicle is restarted, the driver should

always be aware of the surroundings and drive safely.

CAUTION

When the trailer is connected, Rear Cross-Traffic Collision-Avoidance Assist automatically turns off (if equipped). In this case, you cannot get help from Rear Cross-Traffic Collision-Avoidance Assist. Always drive with care.

NOTICE

Rear Cross Safety settings include 'Rear Cross-Traffic Collision-Avoidance Warning' and 'Rear Cross-Traffic Collision-Avoidance Assist'.

NOTICE

If the vehicle is restarted, Warning Volume will maintain the last setting.

Warning volume



- A: Driver Assistance
- 1 Warning Volume
- 2 High
- 3 Medium
- 4 Low

5 Off (If steering wheel vibration function is equipped)

With the vehicle on, touch **Settings** → **Driver Assistance** → **Warning Volume** on the instrument cluster or **Settings** → **Vehicle** → **Driver Assistance** → **Warning Volume** on the infotainment system to change the Warning volume to adjust the Warning volume levels; **High**, **Medium**, **Low** or **Off**.

CAUTION

The settings for Warning Volume applies to all the functions of Rear Cross-Traffic Collision-Avoidance Assist.

NOTICE

- If the vehicle is restarted, Warning volume will maintain the last setting.
- If **Off** is selected, the Warning volume of Rear Cross-Traffic Collision-Avoidance Assist will not turn off, but the volume will sound as **Low**.
- If **Off** is selected, steering wheel vibration (if equipped) will not turn off.
- If you change the Warning volume, the Warning volume of other Driver Assistance systems may change.

Rear Cross-Traffic Collision-Avoidance Assist operation

Rear Cross-Traffic Collision-Avoidance Assist will warn and control the vehicle depending on collision risk level:

'Collision warning', 'Emergency braking' and 'Stopping vehicle and ending brake control'.

Collision warning



A: Collision warning

- To warn the driver of an approaching vehicle from the rear left/right side of your vehicle, the warning light on the outside rearview mirror will blink and a warning will appear on the cluster. At the same time, an audible warning will sound and the steering wheel will vibrate (if equipped). If the Rear View Monitor is operating, a warning will also appear on the infotainment system screen.
- Rear Cross-Traffic Collision-Avoidance Assist will operate when all the following conditions are satisfied:
 - The gear is shifted to R (Reverse)
 - Vehicle speed is below 8 km/h (5 mph)
 - The approaching vehicle is within approximately 25 m (82 ft.) from the left and right side of your vehicle

- The speed of the vehicle approaching from the left and right is above 5 km/h (3 mph)

* NOTICE

- If the operating conditions are satisfied, there will be a warning whenever the vehicle approaches from the left or right side even though your vehicle speed is 0 km/h (0 mph).
- The images and colors in the cluster may differ depending on the cluster type or theme selected from the cluster.

Emergency braking



A: Emergency Braking

- To warn the driver of an approaching vehicle from the rear left/right side of your vehicle, the warning light on the outside rearview mirror will blink and a warning message will appear on the cluster. At the same time, an audible

warning will sound and the steering wheel will vibrate (if equipped). A warning will also appear on the infotainment system screen.

- Emergency braking will be assisted to help prevent collision with approaching vehicles from the left and right.
- Rear Cross-Traffic Collision-Avoidance Assist will operate when all the following conditions are satisfied:
 - The gear is shifted to R (Reverse)
 - Vehicle speed is below 8 km/h (5 mph)
 - The approaching vehicle is within approximately 1.5 m (5 ft.) from the left and right side of your vehicle
 - The speed of the vehicle approaching from the left and right is above 5 km/h (3 mph)

⚠ WARNING

Brake control ends when the conditions of the approaching vehicle from the rear left or right side are as below:

- The approaching vehicle is out of the detecting range
- The approaching vehicle passes behind your vehicle
- The approaching vehicle does not drive toward your vehicle
- The approaching vehicle speed slows down
- The driver depresses the brake pedal with sufficient power

Stopping vehicle and ending brake control



A: Drive carefully

- When the vehicle is stopped due to emergency braking, the warning message will appear on the cluster.
- Brake control will end after the vehicle is stopped by emergency braking for approximately 2 seconds.
- During emergency braking, braking control by Rear Cross-Traffic Collision-Avoidance Assist will automatically cancel when the driver excessively depresses the brake pedal.

⚠ WARNING

- For your safety, change the Settings after parking the vehicle at a safe location.
- If any other system's warning message is displayed or audible warning is generated, Rear Cross-Traffic Collision-Avoidance Assist's warning message may not be displayed and audible warning may not be generated.
- You may not hear the warning sound of Rear Cross-Traffic Collision-Avoidance Assist if the surrounding is noisy.
- Rear Cross-Traffic Collision-Avoidance Assist may not operate if the driver applies the brake pedal to avoid collision.
- During Rear Cross-Traffic Collision-Avoidance Assist operation, the vehi-

cle may stop suddenly injuring passengers and shifting loose objects. Always have the seat belt on and keep loose objects secured.

- Even if there is a problem with Rear Cross-Traffic Collision-Avoidance Assist, the vehicle's basic braking performance will operate properly.

⚠ WARNING

- When Rear Cross-Traffic Collision-Avoidance Assist is operating, braking control by function will automatically cancel when the driver excessively depresses the accelerator pedal.
- Rear Cross-Traffic Collision-Avoidance Assist does not operate in all situations or cannot avoid all collisions.
- Rear Cross-Traffic Collision-Avoidance Assist may warn the driver late or may not warn the driver depending on the road and driving conditions.
- The driver should hold the responsibility to control the vehicle. Do not solely depend on Rear Cross-Traffic Collision-Avoidance Assist. Rather, maintain a safe braking distance, and if necessary, depress the brake pedal to reduce driving speed or to stop the vehicle.
- Never deliberately operate Rear Cross-Traffic Collision-Avoidance Assist on people, animal, objects, etc. It may cause serious injury or death.

⚠ WARNING

The brake control may not operate properly depending on the status of ESC (Electronic Stability Control).

There will only be a warning when:

- The ESC (Electronic Stability Control) warning light is on

- ESC (Electronic Stability Control) is engaged in a different function

*** NOTICE**

- If braking is assisted by Rear Cross-Traffic Collision-Avoidance Assist, the driver must immediately depress the brake pedal and check vehicle surroundings.
- After shifting the gear to R (Reverse), braking control will operate once for left and right vehicle approach.

Rear Cross-Traffic Collision-Avoidance Assist malfunction and limitations

Rear Cross-Traffic Collision-Avoidance Assist malfunction

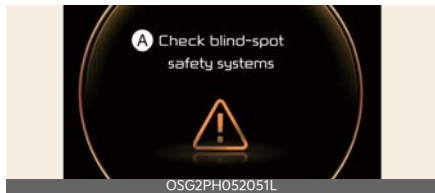

A: Check blind-spot safety systems

When Rear Cross-Traffic Collision-Avoidance Assist is not working properly, the warning message will appear on the cluster for several seconds, and the master (⚠) warning light will appear on the cluster. If this occurs, have the function be inspected by a professional workshop. Kia recommends visiting an authorized Kia dealer/service partner.

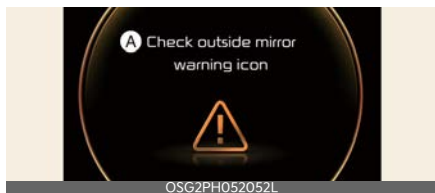

A: Check outside mirror warning icon

When the outside rearview mirror warning light is not working properly, the warning message will appear on the cluster for several seconds, and the master (⚠️) warning light will appear on the cluster. If this occurs, have the function be inspected by a professional workshop. Kia recommends visiting an authorized Kia dealer/service partner.

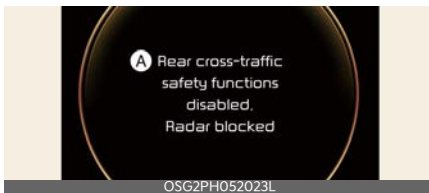
Rear Cross-Traffic Collision-Avoidance Assist disabled**A: Rear cross-traffic safety functions disabled. Radar blocked**

When the rear bumper around the rear-side radar or sensor is covered with foreign material, such as snow or rain, or installing a trailer or carrier, it can reduce the detecting performance and temporarily limit or disable Rear Cross-Traffic Collision-Avoidance Assist.

If this occurs, the warning message will appear on the cluster.

Rear Cross-Traffic Collision-Avoidance Assist will operate properly when such foreign material or trailer, etc., is removed.

If Rear Cross-Traffic Collision-Avoidance Assist does not operate properly after it is removed, have the function be inspected by a professional workshop. Kia recommends visiting an authorized Kia dealer/service partner.

⚠️ WARNING

- Even though the warning message does not appear on the cluster, Rear Cross-Traffic Collision-Avoidance Assist may not operate properly.
- Rear Cross-Traffic Collision-Avoidance Assist may not operate properly in an area (for example, open terrain), where any substance are not detected after turning ON the vehicle.

⚠️ CAUTION

Turn off Rear Cross-Traffic Collision-Avoidance Assist to install or remove a trailer, carrier, or another attachment. Turn on Rear Cross-Traffic Collision-Avoidance Assist when finished.

Limitations of Rear Cross-Traffic Collision-Avoidance Assist

Rear Cross-Traffic Collision-Avoidance Assist may not operate properly, or it may operate unexpectedly under the following circumstances:

- Departing from where trees or grass are overgrown
- Departing from where roads are wet
- Speed of the approaching vehicle is fast or slow

Braking control may not work, driver's attention is required in the following circumstances:

- The vehicle severely vibrates while driving over a bumpy road, uneven road or concrete patch
- Driving on a slippery surface due to snow, water puddle, ice, etc.
- The tire pressure is low or a tire is damaged
- The brake is tuned

- Remote Smart Parking Assist is operating (if equipped)

*** NOTICE**

For more details on the limitations of the rear corner radar, refer to "Blind-Spot Collision-Avoidance Assist (BCA) (if equipped)" on page 6-70.

⚠ WARNING

- Driving near a vehicle or structure



[A]: Structure

Rear Cross-Traffic Collision-Avoidance Assist may be limited when driving near a vehicle or structure, and may not detect the vehicle approaching from the left or right. If this occurs, the function may not warn the driver or control the brakes when necessary. Always check your surroundings while backing up.

- When the vehicle is in a complex parking environment



Rear Cross-Traffic Collision-Avoidance Assist may detect vehicles which are parking or pulling out near your vehicle (example, a vehicle leaving beside your vehicle, a vehicle parking or pulling out in the rear area, a vehi-

cle approaching your vehicle making a turn, etc.).

If this occurs, the function may unnecessarily warn the driver and control the brake.

Always check your surroundings while backing up.

- When the vehicle is parked diagonally



Rear Cross-Traffic Collision-Avoidance Assist may be limited when backing up diagonally, and may not detect the vehicle approaching from the left or right. If this occurs, the function may not warn the driver or control the brakes when necessary. Always check your surroundings while backing up.

- When the vehicle is on or near a slope



Rear Cross-Traffic Collision-Avoidance Assist may be limited when the vehicle is on a uphill or downhill slope, or near it, and may not detect the vehicle approaching from the left or right. If this occurs, the function may not warn the driver or control the brakes when necessary.

Always check your surroundings while backing up.

- Pulling into the parking space where there is a structure

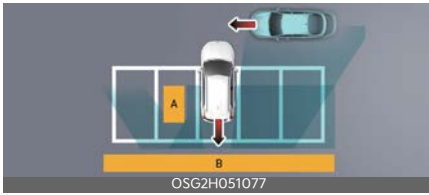

[A]: Structure,

[B]: Wall

Rear Cross-Traffic Collision-Avoidance Assist may detect vehicles passing by in front of you when parking in reverse into a parking space with a wall or structure in the rear or side area. If this occurs, the function may unnecessarily warn the driver and control the brake.

Always check your surroundings while backing up.

- When the vehicle is parked rearward

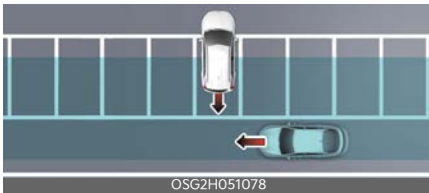

Rear Cross-Traffic Collision-Avoidance Assist may detect vehicles passing by behind you when parking in reverse into a parking space. If this occurs, the function may unnecessarily warn the driver and control the brake.

Always check your surroundings while backing up.

⚠ WARNING

- When you are towing a trailer or another vehicle, turn off Rear Cross-Traffic Collision-Avoidance Assist for safety reasons.
- Rear Cross-Traffic Collision-Avoidance Assist may not operate properly if interfered by strong electromagnetic waves.
- Rear Cross-Traffic Collision-Avoidance Assist may not operate for 3 seconds after the vehicle is started, or the rear corner radars are initialized.

Reverse Parking Distance Warning (PDW) (if equipped)

Reverse Parking Distance Warning will help warn the driver if a person, an animal or an object is detected within a certain distance when the vehicle is moving in reverse.

Detecting sensor

Rear ultrasonic sensors



Refer to the picture above for the detailed location of the detecting sensors.

Reverse Parking Distance Warning settings

Warning volume

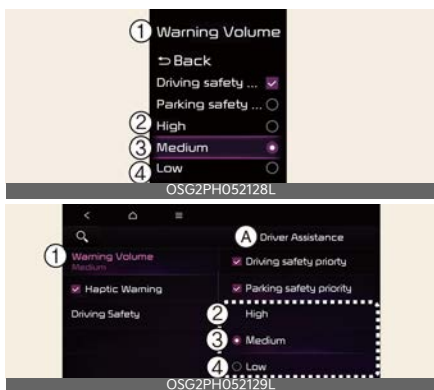

A: Driver Assistance

1 Warning Volume

2 High

3 Medium

4 Low

5 Off (If steering wheel vibration function is equipped)

With the vehicle on, touch **Settings** → **Driver Assistance** → **Warning Volume** on the instrument cluster or **Settings** → **Vehicle** → **Driver Assistance** → **Warning Volume** on the infotainment system to change the Warning volume to adjust the Warning volume levels; **High**, **Medium**, **Low** or **Off**.

⚠ CAUTION

When the trailer is connected, Reverse Parking Distance Warning Assist automatically turns off (if equipped). In this case, you cannot get help from Reverse Parking Distance Warning. Always drive with care.

* NOTICE

- If the vehicle is restarted, Warning volume will maintain the last setting.
- If **Off** is selected, the Warning volume of Reverse Parking Distance Warning will not turn off, but the volume will sound as **Low**.
- If **Off** is selected, steering wheel vibration (if equipped) will not turn off.
- If you change the Warning volume, the Warning volume of other Driver Assistance systems may change.

Reverse Parking Distance Warning operation

Parking Safety button (if equipped)



Press the Parking Safety (P) button to turn on or off Reverse Parking Distance Warning.

- When Reverse Parking Distance Warning is off (button indicator light off), if you shift the gear to R (Reverse), Reverse Parking Distance Warning will automatically turn on.
- If you shift the gear to R (Reverse), Reverse Parking Distance Warning will not turn off even if you press the Parking Safety (P) button for your safety.

Reverse Parking Distance Warning

Reverse Parking Distance Warning will operate under the following conditions.

- Shift the gear to R (Reverse).
- The vehicle's speed is below 10 km/h (6 mph).

Warning indication and warning sound

Distance from object	Warning indicator when driving backward	Warning sound
60~120 cm (24~48 inches)		Buzzer beeps intermittently
30~60 cm (12~24 inches)		Beeps more frequently
within 30 cm (12 inches)		Beeps continuously

- The corresponding indicator will appear on the cluster or infotainment system whenever each ultrasonic sensor detects a person, animal or object in its sensing range. Also an audible warning will sound.
- When more than two objects are detected at the same time, the closest one will be warned with an audible warning.
- Distance from object may be detected differently when obstacles are not located in front of the sensor.
- The shape of the indicator in the illustration may differ from the actual vehicle.

Reverse Parking Distance Warning malfunction and precautions

Reverse Parking Distance Warning malfunction

After starting the vehicle, a beep will sound once when the gear is shifted to R (Reverse) to indicate Reverse Parking Distance Warning is operating normally. However, if one or more of the following occurs, first check whether the ultrasonic sensor is damaged or blocked with

foreign material. If it still does not work properly, Kia recommends visiting an authorized Kia dealer/service partner.

- The audible warning does not sound.
- The buzzer sounds intermittently.
- The warning message appears on the cluster.



A: Ultrasonic sensor error or blockage

Limitations of Reverse Parking Distance Warning

- Reverse Parking Distance Warning may not operate normally when:
 - Moisture is frozen to the sensor (Reverse Parking Distance Warning will operate normally when it is melted.)
 - Sensor is covered with foreign material, such as snow or water (Reverse Parking Distance Warning will operate normally when such foreign material are removed.)
 - The weather is extremely hot or cold
 - The sensor or sensor assembly is disassembled
 - The surface of the sensor is pressed hard or an impact is applied with a hard object
 - The surface of the sensor is scratched with a sharp object
 - The sensors or its surrounding area is directly sprayed with high pressure washer

- Reverse Parking Distance Warning may malfunction when:
 - Heavy rain or water spray is present
 - Water flows on the surface of the sensor
 - Affected by another vehicle's sensors
 - The sensor is covered with snow
 - Driving on uneven road, gravel roads or bushes
 - Objects that generates ultrasonic waves are near the sensor
 - Installing the license plate differently from the original location
 - The vehicle bumper height or ultrasonic sensor installation has been modified
 - Attaching equipments or accessories around the ultrasonic sensors
- The following objects may not be detected:
 - Sharp or slim objects, such as ropes, chains or small poles.
 - Objects, which tend to absorb sensor frequency, such as clothes, spongy material or snow.
 - Objects smaller than 100 cm (40 inches) in length and narrower than 14 cm (6 inches) in diameter.
 - Pedestrians, animals or objects that are very close to the ultrasonic sensors

WARNING

- Reverse Parking Distance Warning is a supplemental function. The operation of Reverse Parking Distance Warning can be affected by several factors (including environmental conditions). It is the responsibility of the

driver to always check the rear view before and while parking.

- Your vehicle warranty does not cover any accidents or damage to the vehicle due to the malfunction of Reverse Parking Distance Warning.
- Pay close attention when driving near objects, pedestrians, and especially children. Some objects may not be detected by the ultrasonic sensors, due to the objects distance, size or material, all of which can limit the effectiveness of the sensor.
- Parking Distance Warning indicator may not occur sequentially depending on vehicle speed or obstacle shape.
- If Reverse Parking Distance Warning needs repair, Kia recommends visiting an authorized Kia dealer/service partner.

Forward/Reverse Parking Distance Warning (PDW) (if equipped)

Forward/Reverse Parking Distance Warning will help warn the driver if an obstacle is detected within a certain distance when the vehicle is moving forward or in reverse at low speeds.

Detecting sensor

Front ultrasonic sensors



Rear ultrasonic sensors



Refer to the picture above for the detailed location of the detecting sensors.

Forward/Reverse Parking Distance Warning settings

Warning volume



A: Driver Assistance

1 Warning Volume

2 High

3 Medium

4 Low

5 Off (If steering wheel vibration function is equipped)

With the vehicle on, touch **Settings** → **Driver Assistance** → **Warning Volume** on the instrument cluster or **Settings** → **Vehicle** → **Driver Assistance** → **Warning Volume** on the infotainment system to change the Warning volume to adjust the Warning volume levels; **High**, **Medium**, **Low** or **Off**.

⚠ CAUTION

When the trailer is connected, Reverse Parking Distance Warning Assist automatically turns off (if equipped). In this case, you cannot get help from Reverse Parking Distance Warning. Always drive with care.

* NOTICE

- If the vehicle is restarted, Warning volume will maintain the last setting.
- If **Off** is selected, the Warning volume of Forward/Reverse Parking Distance Warning will not turn off, but the volume will sound as **Low**.
- If **Off** is selected, steering wheel vibration (if equipped) will not turn off.
- If you change the Warning volume, the Warning volume of other Driver Assistance systems may change.

Parking Distance Warning Auto On

You can set the parking distance warning to be ON at low speeds. To use Parking Distance Warning Auto On function, select **Settings** → **Driver Assistance** → **Parking Safety** → **Parking Distance Warning Auto On** on the instrument cluster or **Settings** → **Vehicle** → **Driver Assistance** → **Parking Safety** → **Parking Distance Warning Auto On** on the infotainment system.

* NOTICE

When **Parking Distance Warning Auto On** is selected, the Parking Safety button indicator (P) stays on.

Parking Distance Warning operation

Control switch

Parking Safety button (if equipped)



- Press the Parking Safety (P+) button to turn on Forward/Reverse Parking Distance Warning. Press the button again to turn off the function.
- When the gear is shift to R (Reverse), Parking Distance Warning will automatically turn on (Parking Safety button indicator on).
- When the gear is in R (Reverse), Parking Distance Warning does not turn off even if the Parking Safety button (3) is pressed.

Forward Parking Distance Warning

Forward Parking Distance Warning will operate under the following conditions.

- The gear is shifted from R (Reverse) to D (Drive) with Reverse Parking Distance Warning on
- The gear is in D (Drive) and the Parking Safety (P+) button indicator light is on
- Forward Parking Distance Warning warns the driver when the vehicle is in D (Drive)

(If **Settings** → **Driver Assistance** → **Parking Safety** → **Parking Distance Warning Auto On** on the instrument cluster or **Settings** → **Vehicle** →



Driver Assistance → **Parking Safety** → **Parking Distance Warning Auto On** on the infotainment system selected)

- Vehicle speed is below 10 km/h (6 mph).

* NOTICE

- Forward Parking Distance Warning does not operate when the vehicle's forward speed is above 10 km/h (6 mph) even when the Parking Safety (P+) button indicator is on. Forward Parking Distance Warning will operate again when the vehicle's forward speed decreases below 10 km/h (6 mph) while the Parking Safety (P+) button indicator is on.
- When the vehicle's forward speed is above 30 km/h (18 mph), the Forward Parking Distance Warning will turn off (Parking Safety button indicator off). Although you drive below 10 km/h (6 mph) again, Forward Parking Distance Warning will not automatically turn on (If **Settings** → **Driver Assistance** → **Parking Safety** → **Parking Distance Warning Auto On** on the instrument cluster or **Settings** → **Vehicle** → **Driver Assistance** → **Parking Safety** → **Parking Distance Warning Auto On** on the infotainment system not selected).

Warning indication and warning sound

Distance from object	Warning indicator when driving forward	Warning sound
60-100 cm (24-40 in.)		Buzzer beeps intermittently
30-60 cm (12-24 in.)		Beeps more frequently
within 30 cm (12 in.)		Beeps continuously

- The corresponding indicator will appear whenever each ultrasonic sensor detects a person, animal or object in its sensing range. Also an audible warning will sound.
- When more than two objects are detected at the same time, the closest one will be warned with an audible warning.
- The shape of the indicator in the illustration may differ from the actual vehicle.

Reverse Parking Distance Warning



Reverse Parking Distance Warning will operate under the following conditions.

- The gear is shifted to R (Reverse).
- Vehicle speed is below 10 km/h (6 mph).

* NOTICE

Parking Distance Warning detects and warns the driver of both rear and front corners, when the vehicle speed is below 10km/h (6mph).

Warning indication and warning sound

Distance from object	Warning indicator when driving backward	Warning sound
60-120 cm (24-48 in.)		Buzzer beeps intermittently
30-60 cm (12-24 in.)		Beeps more frequently
within 30 cm (12 in.)		Beeps continuously

- The corresponding indicator will appear whenever each ultrasonic sensor detects a person, animal or object in its sensing range. Also an audible warning will sound.
- When more than two objects are detected at the same time, the closest one will be warned with an audible warning.
- The shape of the indicator in the illustration may differ from the actual vehicle.

Parking Distance Warning malfunction and limitations

Parking Distance Warning malfunction

After starting the vehicle, a beep will sound when the gear is shifted to R (Reverse) to indicate Parking Distance Warning is operating properly.

However, if one or more of the following occurs, first check whether the ultrasonic sensor is damaged or blocked with foreign material. If it still does not work properly, Kia recommends visiting an authorized Kia dealer/service partner.

- The direction of Parking Distance Warning sensor malfunction is shown on the instrument cluster.



A: Ultrasonic sensor error or blockage

Parking Distance Warning disabled

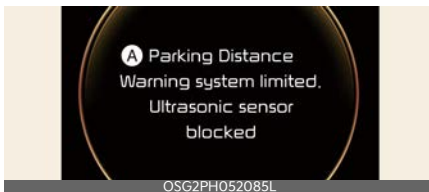

A: Parking Distance Warning system limited. Ultrasonic sensor blocked

If this occurs, the warning message appears on the cluster. Parking Distance Warning will operate properly when snow, rain or foreign material is removed. If Parking Distance Warning does not operate properly after obstruction (snow, rain, or foreign material) is removed (including trailer, carrier, etc., from the rear bumper), Kia recommends visiting an authorized Kia dealer/service partner.

Limitations of Parking Distance Warning

- Parking Distance Warning may not operate properly when:
 - Moisture is frozen to the sensor
 - Sensor is covered with foreign substance, such as snow or water (Parking Distance Warning will

operate properly when such substance is removed.)

- The weather is extremely hot or cold
- The sensor or sensor assembly is disassembled
- The surface of the sensor is pressed hard or hit with a hard object
- The surface of the sensor is scratched with a sharp object
- The sensors or its surrounding area is directly sprayed with high pressure washer
- Parking Distance Warning may malfunction when:
 - Heavy rain or water spray is present
 - Water flows on the surface of the sensor
 - Affected by another vehicle's sensors
 - The sensor is covered with snow or ice
 - Driving on uneven road, gravel roads or bushes
 - Objects that generates ultrasonic waves are near the sensor
 - License plate is installed in a different spot from the original location
 - The vehicle bumper height or ultrasonic sensor installation has been modified
 - Attaching equipment or accessories next to the ultrasonic sensors
- The following objects may not be detected:
 - Sharp or slim objects, such as ropes, chains or small poles.
 - Narrow objects, such as corners of a square column

- Objects, which tend to absorb sensor frequency, such as clothes, spongy material or snow.
- Objects smaller than 100 cm (40 inches) in length and narrower than 14 cm (6 inches) in diameter.
- Pedestrians, animals or objects that are very close to the ultrasonic sensors

⚠ WARNING

- Parking Distance Warning is a supplemental function. The operation of Parking Distance Warning can be affected by several factors (including environmental conditions). It is the responsibility of the driver to always check the front and rear views before and while parking.
- Your new vehicle warranty does not cover any accidents or damage to the vehicle due to the malfunction of Parking Distance Warning.
- Pay close attention when driving near objects, pedestrians, and especially children. Some objects may not be detected by the ultrasonic sensors, due to the objects distance, size or material, all of which can limit the effectiveness of the sensor.
- Parking Distance Warning does not warn you in the order of detection. It varies depending on the speed of the vehicle or the shape of a person, animal, or object.
- If the Parking Distance Warning does not operate properly, Kia recommends visiting an authorized Kia dealer/service partner.

Reverse Parking Collision-Avoidance Assist (PCA) (if equipped)

Reverse Parking Collision-Avoidance Assist can warn the driver or assist with braking to help reduce the possibility of collision with a pedestrian or an object while driving at low speed.

Detecting sensor

Rear view camera



Rear ultrasonic sensors



Parking Collision-Avoidance Assist settings

Parking Safety

With the vehicle on, touch **Settings** → **Vehicle** → **Driver Assistance** → **Parking Safety** on the infotainment system.

- **Rear safety:** Reverse Parking Collision-Avoidance Assist will warn the driver and assist with braking when a collision with a pedestrian or an object is imminent.

*** NOTICE**

Rear safety will be selected and Parking Collision-Avoidance Assist settings will be retained whenever the vehicle is restarted.

Turning Parking Collision Avoidance Assist On/Off



Press and hold the Parking Safety (P) button more than 2 seconds, 'Rear Active Assist' or to turn the Parking Collision-Avoidance Assist on or off.

Rear Safety settings

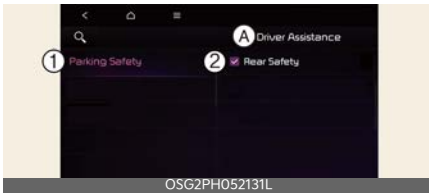

A: **Driver Assistance**

- 1 **Parking Safety**
- 2 **Rear Safety**

With the vehicle on, touch **Settings** → **Vehicle** → **Driver Assistance** → **Parking Safety** → **Rear Safety** on the infotainment system to set the Rear Safety.

⚠ CAUTION

When the trailer is connected, Reverse Parking Collision-Avoidance Assist automatically turns off (if equipped). In this case, you cannot get help from Reverse

Parking Collision-Avoidance Assist. Always drive with care.

*** NOTICE**

- If the vehicle is restarted, Warning volume will maintain the last setting.
- If **Off** is selected, the Warning volume of Reverse Parking Collision-Avoidance Assist will not turn off, but the volume will sound as **Low**.
- If **Off** is selected, steering wheel vibration (if equipped) will not turn off.
- If you change the Warning volume, the Warning volume of other Driver Assistance systems may change.

Warning volume



A: **Driver Assistance**

- 1 **Warning Volume**
- 2 **High**
- 3 **Medium**
- 4 **Low**
- 5 **Off** (If steering wheel vibration function is equipped)

With the vehicle on, touch **Settings** → **Vehicle** → **Driver Assistance** → **Warning Volume** on the infotainment system to change the Warning volume to adjust the Warning volume levels; **High**, **Medium**, **Low** or **Off**.

*** NOTICE**

- If the vehicle is restarted, Warning volume will maintain the last setting.
- If **Off** is selected, the Warning volume of Reverse Parking Collision-Avoidance Assist will not turn off, but the volume will sound as **Low**.
- If **Off** is selected, steering wheel vibration (if equipped) will not turn off.
- If you change the Warning volume, the Warning volume of other Driver Assistance systems may change.

Parking Collision-Avoidance Assist operation

Operating conditions

Select 'Rear Safety' from the 'Parking Safety' menu of the infotainment system. Parking Collision-Avoidance Assist is enabled when the following conditions are satisfied:

- The tailgate and door are closed
- The Electronic Parking Brake (EPB) is released
- A trailer is not connected
- The gear is shifted to R (Reverse)
- Vehicle speed is below 10 km/h (detecting pedestrians)
- Vehicle speed is below 4 km/h (detecting objects)
- Parking Collision-Avoidance Assist components such as the rear view camera and the rear ultrasonic sensors are in normal conditions

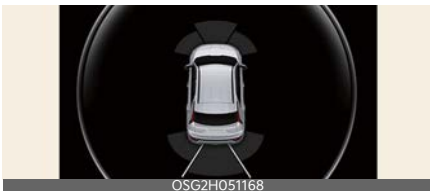

When Parking Collision-Avoidance Assist activates, a line appears behind the vehicle image in the instrument cluster.

*** NOTICE**

Parking Collision-Avoidance Assist operates only once after shifting the gear to R (Reverse). To reactivate Parking Collision-Avoidance Assist, shift the gear from another gear to R (Reverse).

Parking Collision-Avoidance Assist

If Parking Collision-Avoidance Assist detects a risk of collision around the vehicle with a pedestrian or an object, Parking Collision-Avoidance Assist will warn the driver with an audible warning and warning message on the instrument cluster. If the infotainment screen is on, a warning will appear on the screen.

If collision is imminent, Parking Collision-Avoidance Assist will assist you with braking.

Braking assist is released after 5 minutes. Immediately depress the brake pedal and check vehicle surroundings.

Braking assist is also released in the following conditions when:

- The gear is shifted to P (Park) or D (Drive)
- The brake pedal is depressed with sufficient power

*** NOTICE**

When Parking Collision-Avoidance Assist is activated while reversing, braking control will be released after 5 minutes and the Electronic Parking Brake (EPB) will be engaged.

Parking Collision-Avoidance Assist malfunction and limitations

Parking Collision-Avoidance Assist malfunction



When Parking Collision-Avoidance Assist or other related functions are not working properly, the warning message will appear on the cluster, and Parking Collision-Avoidance Assist will turn off automatically. Kia recommends visiting an authorized Kia dealer/service partner.

Parking Collision-Avoidance Assist disabled

Rear view camera



The wide angle cameras are used as detecting sensors to detect pedestrians. If the camera lens is covered with foreign material, such as snow or rain, it may adversely affect camera performance and Parking Collision-Avoidance Assist may not operate properly. Always keep the camera lens clean.

Rear ultrasonic sensors



The ultrasonic sensors detect objects around the vehicle. If the sensors are covered with foreign material, such as snow or rain, it may adversely affect sensor performance and Parking Collision-Avoidance Assist may not operate properly. Always keep the rear bumper clean.

Warning message

Rear view camera

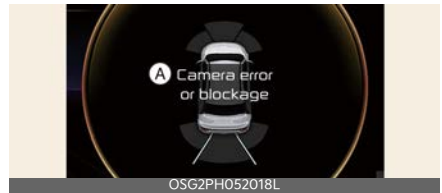

A: Camera error or blockage

Rear ultrasonic sensors

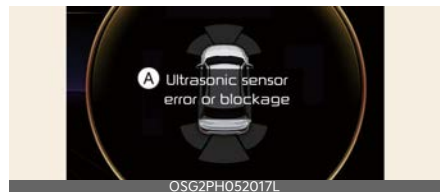

A: Ultrasonic sensor error or blockage

The warning message will appear on the cluster if the following situations occur:

- The camera(s) or ultrasonic sensor(s) is covered with foreign material, such as snow or rain, etc.

- There is inclement weather, such as heavy snow, heavy rain, etc.

If this occurs, Parking Collision-Avoidance Assist may turn off or may not operate properly. Check whether the cameras and ultrasonic sensors are clean.

Limitations of Parking Collision-Avoidance Assist

Parking Collision-Avoidance Assist may not assist braking or warn the driver even if there are pedestrians or objects under the following circumstances:

- There is a problem with the vehicle
- Any non-factory equipment or accessory is installed
- Your vehicle is unstable due to an accident or other causes
- Bumper height or rear ultrasonic sensor installation has been modified
- Wide view camera(s) or ultrasonic sensor(s) is damaged
- Wide view camera(s) or the ultrasonic sensor(s) is stained with foreign material, such as snow, dirt, etc.
- There is a problem with the surroundings
- Wide view camera(s) is obscured by a light source or by inclement weather, such as heavy rain, fog, snow, etc.
- The surrounding is very bright or very dark
- Outside temperature is very high or very low
- The wind is either strong (above 20 km/h (12 mph)) or blowing perpendicular to the rear bumper
- Objects generating excessive noise, such as vehicle horns, loud motorcycle vehicles or truck air brakes, are near your vehicle

- An ultrasonic sensor with similar frequency is near your vehicle
- The road is slippery or inclined
- There is a problem with the pedestrians or objects
- The pedestrians are difficult to detect
- There is ground height difference between the vehicle and the pedestrian
- The image of the pedestrian in the front view camera is indistinguishable from the background
- The pedestrian is near the rear edge of the vehicle
- The pedestrian is not standing upright
- The pedestrian is either very short or very tall to detect
- The pedestrian or cyclist is wearing clothing that easily blends into the background, making it difficult to detect
- The pedestrian is wearing clothing that does not reflect ultrasonic waves well
- Size, thickness, height, or shape of the object does not reflect ultrasonic waves well (for example, pole, bush, curbs, carts, edge of a wall, etc.)
- The pedestrian or the object is moving
- The pedestrian or the object is very close to the rear of the vehicle
- There is a large object such as a wall is behind the pedestrian or the object
- The object is not located at the front or rear center of your vehicle
- The object is not parallel to the rear bumper
- There is a problem with the driving conditions

Driving your vehicle

- The driver drives the vehicle immediately after shifting to R (Reverse) or D (Drive)
- The driver accelerates or circles the vehicle

Parking Collision-Avoidance Assist may unnecessarily warn the driver or assist with braking even if there are no pedestrians or objects under the following circumstances:

- There is a problem with the vehicle
- Any non-factory equipment or accessory is installed
- Your vehicle is unstable due to an accident or other causes
- Bumper height or rear ultrasonic sensor installation has been modified
- Your vehicle height is low or high due to heavy loads, abnormal tire pressure, etc.
- Wide view camera(s) or the rear ultrasonic sensor(s) is stained with foreign material, such as snow, dirt, etc.
- There is a problem with the surroundings
- The pattern on the road is mistaken for a pedestrian
- There is shadow or light reflecting on the ground
- Pedestrians or objects are around the path of the vehicle
- Objects generating excessive noise, such as vehicle horns, loud motorcycle vehicles or truck air brakes, are near your vehicle
- Your vehicle is backing towards a narrow passage or parking space
- Your vehicle is backing towards an uneven road surface, such as an unpaved road, gravel, bump, gradient, etc.

Reverse Parking Collision-Avoidance Assist (PCA)

- A trailer or carrier is installed on the rear of your vehicle
- An ultrasonic sensor with similar frequency is near your vehicle
- An ultrasonic sensor with similar frequency is near your vehicle

WARNING

- Always pay extreme caution while driving. The driver is responsible for controlling the brake for safe driving.
- Always look around your vehicle to make sure there are no pedestrians or objects before moving the vehicle.
- The performance of Parking Collision-Avoidance Assist may vary under certain conditions. If vehicle speed is above 4 km/h (2 mph), Parking Collision-Avoidance Assist will provide collision avoidance assist only when pedestrians are detected. Always look around and pay attention when driving your vehicle.
- Some objects may not be detected by the rear ultrasonic sensors due to the objects distance, size or material, all of which can limit the effectiveness of the sensor.
- Parking Collision-Avoidance Assist may not operate properly or may operate unnecessarily depending on the road conditions and the surroundings.
- Do not solely rely on Parking Collision-Avoidance Assist. Doing so may lead to vehicle damage or injuries.
- Always keep the wide angle cameras and ultrasonic sensors clean.
- Do not use any cleanser containing acid or alkaline detergents when cleaning the camera lens. Use only a mild soap or neutral detergent, and rinse thoroughly with water.

- Do not spray the wide angle cameras or the rear ultrasonic sensors or their surrounding area directly with a high pressure washer. It may cause the wide angle cameras or the ultrasonic sensors to malfunction.
- Do not apply objects, such as a bumper sticker or a bumper guard, near the wide angle cameras or ultrasonic sensors or apply paint to the bumper. Doing so may adversely affect the performance of Parking Collision-Avoidance Assist.
- Never disassemble or apply impact on the wide angle cameras or the ultrasonic sensors components.
- Do not apply unnecessary force on the wide angle cameras or the ultrasonic sensors. Parking Collision-Avoidance Assist may not operate properly if the wide angle cameras or the ultrasonic sensor(s) is forcibly moved out of proper alignment. Kia recommends visiting an authorized Kia dealer/service partner.
- Noise may be heard when sudden braking occurs to avoid a collision.
- If any other warning sound such as the seat belt warning chime is already generated, Parking Collision-Avoidance Assist warning may not sound.
- Parking Collision-Avoidance Assist may not work properly if the bumper has been damaged, replaced or repaired.
- Parking Collision-Avoidance Assist may not operate properly if interfered by strong electromagnetic waves.
- Playing the vehicle audio system at high volume may prevent passengers from hearing Parking Collision-Avoidance Assist warning sounds.

- The brake control may not operate properly depending on the status of ESC (Electronic Stability Control). There will only be a warning when:
 - The ESC (Electronic Stability Control) warning light is on
 - ESC (Electronic Stability Control) is engaged in a different function
- Check your brake fluid and brake pad conditions regularly. The brake performance may decrease depending on brake conditions.

* NOTICE

Parking Collision-Avoidance Assist can detect a pedestrian or an object when:

- A pedestrian is standing behind the vehicle
 - A large obstacle, such as a vehicle, is parked in the rear center of your vehicle
-

Remote Smart Parking Assist (RSPA) (if equipped)

Remote Smart Parking Assist uses vehicle sensors to help the driver park and exit parking spaces remotely from outside the vehicle by controlling the steering wheel, vehicle speed and gearshifts.

Function	Description
Remote Operation	Remotely moving forward or backward 

- Remote Operation function may be operated from outside the vehicle using the smart key.
- When Remote Smart Parking Assist operates, Parking Distance Warning and Rear View Monitor will also operate. For more details, refer to "Forward/Reverse Parking Distance Warning (PDW) (if equipped)" on page 6-143, and "Rear View Monitor (RVM) (if equipped)" on page 6-128.

Detecting sensor

Front ultrasonic sensors



Front side ultrasonic sensors



Rear side ultrasonic sensors



Rear ultrasonic sensors



Refer to the picture above for the detailed location of the detecting sensors.

⚠ CAUTION

- Never disassemble the detecting sensor or sensor assembly, or cause any damage to it.
- If the detecting sensors need repair, we recommend that you have your vehicle inspected by an authorized Kia dealer/service partner.
- Remote Smart Parking Assist may malfunction if the vehicle bumper height or ultrasonic sensor installation has been modified or damaged. Any non-factory installed equipment or accessories may also interfere with the sensor performance.
- When the ultrasonic sensor is frozen or stained with snow, dirt, or water, the sensor may not operate until the stains are removed using a soft cloth.
- Do not push, scratch or strike the ultrasonic sensor. Sensor damage could occur.

- Do not spray the ultrasonic sensors or its surrounding area directly with a high pressure washer.

Remote Smart Parking Assist settings

Warning volume



A: Driver Assistance

1 Warning Volume

2 High

3 Medium

4 Low

5 Off (If steering wheel vibration function is equipped)

With the vehicle on, touch **Settings** → **Vehicle** → **Driver Assistance** → **Warning Volume** on the infotainment system to change the Warning volume to adjust the Warning volume levels; **High**, **Medium**, **Low** or **Off**.

⚠ CAUTION

When the trailer is connected, Remote Smart Parking Assist automatically turns off (if equipped). In this case, you cannot get help from Remote Smart Parking Assist. Always drive with care.

* NOTICE

- If the vehicle is restarted, Warning volume will maintain the last setting.
- If **Off** is selected, the Warning volume of Remote Smart Parking Assist will

not turn off, but the volume will sound as **Low**.

- If **Off** is selected, steering wheel vibration (if equipped) will not turn off.
- If you change the Warning volume, the Warning volume of other Driver Assistance systems may change.

Remote Smart Parking Assist operation

Remote Smart Parking Assist button

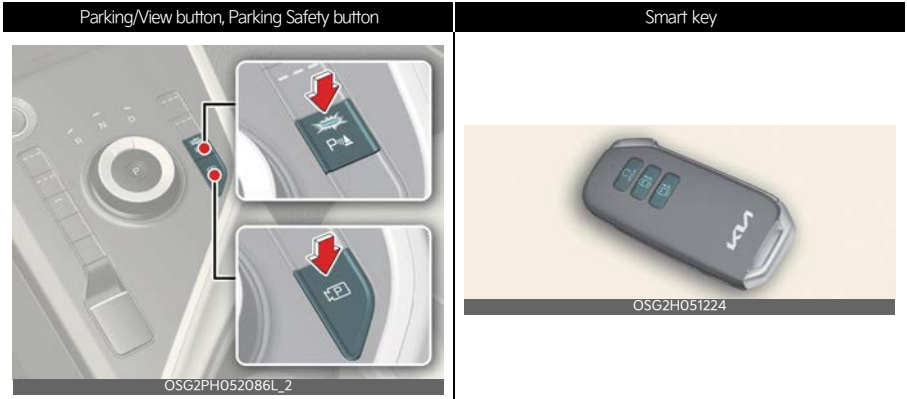

Location	Name	Symbol	Description
Inside vehicle	Parking/View button		<ul style="list-style-type: none"> Press and hold the Parking/View button to turn on Remote Smart Parking Assist. Also, Forward/Reverse Parking Distance warning will automatically turn on.
	Parking Safety button		<ul style="list-style-type: none"> Press the Parking Safety button while Remote Smart Parking Assist is operating to end function operation.
Smart key	Remote Start button		<ul style="list-style-type: none"> Press the Remote Start button after the door is locked with the vehicle off to start the vehicle remotely. Press the Remote Start button while Remote Operation function is operating to end function operation.
	Forward button		<ul style="list-style-type: none"> When using the Remote Operation function, the vehicle moves in the direction of the button while the button is pressed.
	Backward button		

Remote Operation

Operating order

Remote Operation operates in the following order:

1. Getting ready to remotely move forward and backward
2. Remotely moving forward and backward

1. Getting ready to remotely move forward and backward

There are two ways to operate Remote Operation function.

Method (1): Using the function with vehicle off



1. Within a certain range from the vehicle press the door lock (🔒) button on the smart key and lock all doors.
2. Press and hold the Remote Start button (🔘
HOLD) within 4 seconds until the vehicle starts.

* For more details on remotely starting the vehicle, refer to "Starting the vehicle remotely (if equipped)" on page 5-7.

Method (2): Using the function with vehicle on



A: REMOTE Parking instructions

1. Leave the vehicle (keep the key) and close the doors.
2. Press and hold the parking button on the Smart Key.

1. Park the vehicle in front of the space where you want to use Remote Operation function, and shift the gear to P (Park).
2. Press and hold the Parking/View (P) button to turn on Smart Parking Assist. A message will appear on the infotainment system screen.
3. Get out of the vehicle with the smart key and close all doors.

* NOTICE





'Agree' must be selected on the infotainment system screen and the infotainment system has to operate properly to use Remote Operation function.

2. Remote Operation



1. Press and hold one of the Forward (🔘) or Backward (🔘) button on the smart key.
 - Remote Smart Parking Assist will automatically control the steering

wheel, vehicle speed and gear shift. The vehicle will move in the direction of the button pressed.

- While Remote Operation function is operating, if you let the button, the vehicle will stop and function control will pause. The function will start operating again when the button is pressed and held again.
2. Hold down the Forward () or Backward () button until the vehicle reaches the target location.
 3. When Remote Operation is done, get in the vehicle with the smart key or press the Remote Start () button on the smart key from outside the vehicle.
 - The message will appear on the infotainment system screen. The vehicle will automatically shift to P (Park) and engage the parking brake.
 - When the Remote Start () button is pressed, the vehicle will turn off. If the driver is in the vehicle, the vehicle will retain ON position.

* NOTICE

- Remote Operation can control the vehicle remotely using the smart key outside the vehicle.
- Check that all smart keys are outside the vehicle when using Remote Operation function.
- Remote Operation function will operate only when the smart key is within 4 m (13 ft.) from the vehicle. If there is no vehicle movement even when the Forward or Backward button is pressed on the smart key, check the

distance to the vehicle and press the button again.

- The detecting range of the smart key may vary depending on the surroundings that are affected by radio waves such as transmission tower, broadcast station, etc.
- When remotely moving forward using method (1), it is recognized as an exit situation, and the vehicle moves 4 m (13 ft.) to check for pedestrians, animals or objects around the vehicle. After confirmation, the steering wheel is controlled according to the condition ahead.
- When remotely moving forward using method (2), it is recognized as a parking situation, and will immediately control the steering wheel according to the condition ahead to assist with entering the parking space and aligning the vehicle. However, performance may reduce depending on the pedestrians, animals, shape of objects, location, etc., around the vehicle.
- For moving remotely backward, both method (1) and (2) aligns the steering wheel first, and then will only move the vehicle straight.

⚠ WARNING

- When using Remote Operation function, make sure that all passengers have gotten out of the vehicle.
- If the vehicle's battery is discharged or Remote Smart Parking Assist malfunctions when parked in a narrow parking space, Remote Operation function will not operate. Always park your vehicle in a space wide enough for you to get in or out of your vehicle.

- Please note that depending on the parking space, you may not be able to exit from the space you have entered by using Remote Operation function.
- After parking, the surrounding may change due to the movement of surrounding vehicles. If this occurs, Remote Operation function may not operate.
- Before leaving the vehicle, close windows and sunroofs, and make sure the vehicle is off before locking the doors.



Remote Operation function operation status

Operation Status	Smart key LED	Hazard warning light
Under control	Green LED continuously blinks	-
Pause	Red LED continuously blinks	Blinks
Off	Red LED appears for 4 seconds and then turns off	Blinks 3 times and turns off
Complete	Green LED appears for 4 seconds and then turns off	Blinks 3 times and turns off

* NOTICE



- Operation status by the hazard warning light may not be applicable based on the regulation of your country.
- If the smart key is not within the operating range from the vehicle (approximately 4m (13 ft.)), the smart key LED will not appear or blink. Use the smart key within the operating range.

How to turn off Remote Operation function while operating

- Press the Parking/View () button or shift the gear except to P (Park) while the infotainment system screen guides the driver using method 2.
- Press the Parking Safety () button or select 'Cancel' on the infotainment system screen.
- Press the Remote Start () button on the smart key while the vehicle is being controlled by Remote Operation function. Remote Operation function will turn off. At this time, the vehicle will turn off.
- Get on the vehicle with the smart key. Remote Operation function will turn off. At this time, the vehicle will remain on.

The function will pause in the following conditions when:

When Remote operation function is paused, the vehicle will stop. If the condition that made the function to pause disappears, the function may operate again.

- There is a pedestrian, animal or object in the direction the vehicle is moving
- The door or tailgate is open
- The Forward () or Backward () button is not continuously pressed
- Simultaneously pressing multiple buttons on a smart key
- The smart key is not operated within 4 m (13 ft.) from the vehicle
- Button of another smart key is pressed in addition to the operating smart key (Excluding start button)

- Blind-Spot Collision-Avoidance Assist or Rear Cross-Traffic Collision-Avoidance Assist operates while the vehicle is being controlled in the reverse direction.
- The vehicle moves 7 m (22 ft.) while the smart key is pressed with Remote Operation function (maximum travel distance per button press)

The function will cancel in the following conditions when:

When Remote Operation function is canceled, the vehicle will automatically stop, shift the gear to P (Park) and engage EPB (Electronic Parking Brake).

- The steering wheel is steered
- The gear is shifted while the vehicle is moving
- Operating EPB while the vehicle is moving
- The hood is open
- The brake pedal or accelerator pedal is depressed when all the doors are closed
- The smart key is outside the vehicle when the brake pedal is depressed while the driver's door is open
- Rapid acceleration occurs
- Vehicle skid occurs
- The wheel is stuck by an obstacle and cannot move
- Approximately 3 minutes and 50 seconds have past after Remote Operation function has started to operate
- The slope of the road exceeds the operational range
- The function is paused for more than 1 minute

- The total travel distance of the vehicle has exceeded 14 m (45 ft.) after Remote Operation function operation
- The steering wheel, gearshift, braking, and drive controls are not working properly
- There is a problem with the smart key or the smart key battery is low
- ABS, TCS or ESC system operates due to slippery road conditions
- The alarm of the Theft Alarm System sounds

Remote Smart Parking Assist malfunction and limitations

Remote Smart Parking Assist malfunction

Remote Smart Parking Assist check



A: Check Parking Assist

1 Visit a nearby service center.

When Remote Smart Parking Assist is not working properly, the warning message will appear on the infotainment system screen. If the message appears, stop using Remote Smart Parking Assist, and we recommend that you have your vehicle inspected by an authorized Kia dealer/service partner.

Remote Smart Parking Assist canceled



A: Parking Assist cancelled.
1 Please refer to owner's manual.

When Remote Parking Assist is operating, the function can be canceled, and the warning message may appear regardless of the parking order. Other messages may appear depending on the situations. Follow the instructions provided on the infotainment system screen while parking your vehicle with Remote Parking Assist. Always look around and pay attention when using Remote Smart Parking Assist.

Remote Smart Parking Assist standby



A: Parking Assist conditions not met
1 Please refer to owner's manual.

When the message appears, when Parking/View (P) button has been pressed and held, Remote Smart Parking Assist is in standby. After a while, press and hold the Parking/View (P) button again to see if Remote Smart Parking Assist works.

The message appears even when the smart key's battery is low. Check the smart key battery level.

Limitations of Remote Smart Parking Assist

In the following circumstances, Remote Smart Parking Assist performance to park or exit the vehicle may be limited, there may be a risk of collision, or Remote Smart Parking Assist may turn off. Park or exit the vehicle manually if necessary.

- An object is attached to the steering wheel
- The vehicle is installed with a snow chain, spare tire or different size wheel
- Tire pressure is lower or higher than the standard tire pressure
- Your vehicle is loaded with cargo longer or wider than your vehicle or a trailer is connected to your vehicle
- There is a problem with the wheel alignment
- Your vehicle is leaned severely to one side
- Your vehicle is equipped with a trailer hitch
- The license plate is installed differently from the original location
- There is a person, animal or object above or below the ultrasonic sensor when Remote Smart Parking Assist is activated
- There is an obstacle such as a person, animal or object (trash can, bicycle, motorcycle, shopping cart, narrow pillar, etc.) near the parking space
- There is a circular pillar or narrow pillar, or a pillar surrounded by objects such as fire extinguisher, etc., near the parking space

- The road surface is bumpy (curbstone, speed bump, etc.)
- The road is slippery
- The parking space is near a vehicle with higher ground clearance or big, such as a truck, etc.
- The parking space is Inclined
- The road surface of parking space with lines is wet due to snow, puddles, or there is a road marker inside the parking space
- There is heavy wind
- Operating Remote Smart Parking Assist on uneven roads, gravel roads, bushes, etc.
- The performance of the ultrasonic sensor is affected by extremely hot or cold weather
- The ultrasonic sensor is covered with snow or water
- An object that generates ultrasonic waves is nearby
- A wireless device with a transmission function operates near the ultrasonic sensors
- Your vehicle is affected by another vehicle's Parking Distance Warning
- The sensor is mounted or positioned incorrectly by an impact to the bumper
- The ultrasonic sensor cannot detect the following objects when:
 - Sharp or slim objects, such as ropes, chains or small poles
 - Objects smaller than 100 cm (40 in.) in length and narrower than 14 cm (6 in.) in diameter
 - Objects which tend to absorb sensor frequency, such as clothes, spongy material or snow

- A narrow object such as a corner of a square pillar
- Person, animal or object near the ultrasonic sensor

Remote Smart Parking Assist may not operate properly under the following circumstances:

- Parking on inclines



Park manually when parking on inclines.

- Parking in snow



Snow may interfere with sensor operation, or Remote Smart Parking Assist may cancel if the road is slippery while parking.

- Parking on uneven road



Remote Smart Parking Assist may cancel when the vehicle slips, or the vehicle cannot move due to road conditions such as pebbles or fragmented stones.

- Parking behind a truck



Do not use Remote Smart Parking Assist around vehicles with higher ground clearance, such as a bus, truck, etc. It may lead to an accident.

- Parking near a pillar



Remote Smart Parking Assist performance may reduce or collision with an obstacle may occur when there is a narrow object, circular pillar, square pillar, or a pillar surrounded by objects such as a fire extinguisher, etc., near the parking space. The driver should park the vehicle properly.

- Parking in a parking space with a vehicle on one side only



If Remote Smart Parking Assist is used, when parking in a parking space with a vehicle only on one side, your vehicle may cross the parking line to avoid the parked vehicle.

- Parking diagonal

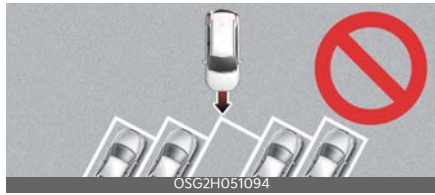

Remote Smart Parking Assist does not provide diagonal parking. Even if your vehicle was able to enter the parking space, do not use Remote Smart Parking Assist because the function cannot operate properly.

⚠ WARNING

- The driver is responsible for safe parking and exit when using Remote Smart Parking Assist.
- When using Remote Smart Parking Assist, stay out of the way in the direction the vehicle moves for your safety.
- Always check surroundings when using Remote Smart Parking Assist. You may collide with pedestrians, animals, or objects if they are near the sensor or are in the sensor's blind spot area.
- A collision may occur if a pedestrian, animal, or object suddenly appears while Remote Smart Parking Assist is operating.
- Do not use Remote Smart Parking Assist when under the influence of alcohol.
- Do not let children or other people to use the smart key.
- If Remote Smart Parking Assist is used continuously for a long period, it may adversely affect Remote Smart Parking Assist performance.
- Remote Smart Parking Assist may not operate properly if the vehicle needs

wheel alignment adjustment such as when the vehicle tilts to one side. We recommend that you have your vehicle inspected by an authorized Kia dealer/service partner.

- Noise may be heard when braking occurs by Remote Smart Parking Assist or when the brake pedal is depressed by the driver.
- Remote Smart Parking Assist may suddenly apply the brake to avoid collision.
- Use Remote Smart Parking Assist only in a parking space that is large enough for the vehicle to move safely.

* NOTICE

- If the 3rd stage warning (continuous beep) of the Forward/Reverse Parking Distance Warning sounds while Remote Smart Parking Assist is operating, it means the obstacle detected is close to your vehicle. At this time, Remote Smart Parking Assist will temporarily stop operating. Make sure there are no pedestrians, animals, or objects around your vehicle.
- Depending on brake operation, the stop lights may come on while the vehicle is moving.
- If the vehicle is remotely started that has been parked in cold weather for a long time, the operation of Remote Smart Parking function may be delayed or canceled depending on vehicle condition.

Declaration of conformity (if equipped)

The radio frequency components (Front Radar) complies:

For Europe and countries subject to CE certification



OGL3051237L

Model : MRR-30

Hereby MRR-30 has been so constructed that it can be operated in at least one Member State without infringing applicable requirements of use of radio spectrum. (RED article 10.2)

Hereby, Mando Corp declares that the radio equipment type MRR-30 is in compliance with Directive 2014/53/EU.

The full text of the EU declaration of conformity is available at the following internet address:
<https://www.mando.com/nd/nd04.jsp>

OGL3051238L

For Taiwan



OGL3051239L

CCAF19LP2840TO

(1) 經型式認證合格之低功率射頻電機，非經許可，公司、商號或使用者均不得擅自變更頻率、加大功率或變更原設計之特性及功能。
 (2) 低功率射頻電機之使用不得影響飛航安全及干擾合法通信；經發現有干擾現象時，應立即停用，並改善至無干擾時方得繼續使用。前項合法通信，指依電信法規定作業之無線電通信。低功率射頻電機須忍受合法通信或工業、科學及醫療用電波輻射性電機設備之干擾。

(1) Without permission granted by NCC, any company, enterprise, or user is not allowed to change frequency, enhance transmitting power or alter original characteristic as well as performance to a approved low power radio-frequency devices.
 (2) The low power radio-frequency devices shall not influence aircraft security and interfere legal communications: If found, the user shall cease operating immediately until no interference is achieved. The said legal communications means radio communications is operated in compliance with the Telecommunications Act.
 The low power radio-frequency devices must be susceptible with the interference from legal communications or ISM radio wave radiated devices.

OGL3051240L

For Australia



OGL3051241L

For Serbia



H011 20

OGL3051242L

For Oman

OMAN - TRA
 TRA/TA-R/8804/19
 D182437

OGL3051243L

For Moldova



OGL3051244L

For Ukraine



UA RF: 3MAND3MRR

OGL3051245L

26. Manufacturers should ensure that radio equipment is accompanied by instructions and safety information in accordance with the law on the use of languages.

Instructions should include the information necessary to use the radio equipment according to its purpose. Such information contains, in the presence of a description of the components and accessories, including software that allows the radio equipment to work for its intended purpose. Such instructions and safety instructions, as well as any labeling, must be clear, understandable and legible.

An instruction for radio equipment intended to emit radio waves must additionally contain:

band (band) of radio frequencies, in which (in which) the radio equipment operates;

the maximum radiation power in the band (s) of radio frequencies, in which (in which) radio equipment is operating.

OGL3051246L

For UAE

	TRA – United Arab Emirates Dealer ID : _____ TA RTE : _____ Model: _____ Type: _____	
---	--	---

DEALER No. : DA58500/16
 REGISTERED No: ER77591/19
 MODEL : MRR-30

OSG2PH052091L

For Brazil



XXXXX-XX-XXXXX
 00084-20-09644

OGL3051248L

For Ghana

NCA Approved : SR0-1M-7E4-X19

OGL3051250L

For Singapore

**Complies with
 IMDA Standards
 [Dealer's Licence No.]**

Dealer's Licence : DA107248

OGL3051249L

For Russia



OGL3051251L

For Malaysia



HIDF16000136

OGL3051252L

For Jordan

Model : MRR-30
 Serial No : _____
 Year of Manufacture : _____

OGL3051253L

For Mexico

IFETEL : RCPMAMR20-0338

"La operación de este equipo está sujeta a las siguientes dos condiciones:
 (1) es posible que este equipo o dispositivo no cause interferencia perjudicial y
 (2) este equipo o dispositivo debe aceptar cualquier interferencia, incluyendo la que pueda causar su operación no deseada."
 and RCPMAMR20-0338

OGL3051254L

For Israel

Ministry of Communication permit number :
51-71611
OGL3051255L

For Morocco

Numéro d'agrément :MR 22027 ANRT 2019
Date d'agrément : 2020-01-09
OGL3051256L

For Argentina

CNC + H-24543
OGL3051257L

For Philippines

Type Approved
No. ESD-2021666C
OGL3051258L

For Paraguay

+ NR : 2020-02-I-0114
OGL3051259L

For Uzbekistan

OGL3051260L

For Benin

Numero d'agrément:
070/ARCEP/SE/DAR/DJPC/2020
Date d'agrément: 18 MARS 2020:
OGL3051261L

For Thailand

 CLASS A
NBTC ID : A57015-19
OGL3051262L

The radio frequency components (Front Corner Radar/Rear Corner Radar) complies: (if equipped)

For Mexico

IFETEL: RCPAPH519-1602
"La operación de este equipo está sujeta a las siguientes dos condiciones:
(1) es posible que este equipo o dispositivo no cause interferencia perjudicial y (2) este equipo o dispositivo debe aceptar cualquier interferencia, incluyendo la que pueda causar su operación no deseada."
OGL3051265L

For Ukraine



UA RF: 1APT V H5TR

OGL3051266L

справжнім (найменування виробника) заявляє, що тип радіобладнання (позначення типу рад іообладнання) відповідає Технічному регламенту р адіообладнання:

повний текст декларації про відповідність доступни й на веб-сайті за такою адресою:

www.ap tiv.com/automotive-homologation

OGL3051267L

For Ghana

NCA approved: ZRO-MB-7E3-249

OGL3051268L

For Republic of South Africa



OGL3051269L

For Japan

This device is granted pursuant to the Japanese Radio Law

under the grant ID n° : 203-JN1053

This device should not be modified (otherwise the granted designation number will become invalid)

本製品は、電波法に基づく特定無線設備の技術基準適合証明などを受けております。 認証番号: 203-JN1053

本製品の改造は禁止されています。(適合証明番号などが無効となります。)

OGL3051270L

For Serbia



И61819

OGL3051271L

For Paraguay



NR: 2019-12-I-0671

OGL3051272L

For Malaysia



MCMC
CIDF17000143

OGL3051273L

For Singapore

Complies with
IMDA Standards
DA 103787

OSG2PH052093L

For Europe and CE certified countries

Declaration of Conformity
Radiocontrolled Vehicle components



Hereby, APTIV, 42367 Wuppertal declares that this J4TR/J4TRh is in compliance with the essential requirements and/or relevant provisions of Directive 2014/53/EU (RED).
The original declaration of conformity can be accessed at the following link : www.aptiv.com/automotive-homologation

frequency band 76-77 GHz
Maximum Output Power 30 dBm (1.0 W)

OGL3051275L

For Thailand



เครื่องวิทยุคมนาคมนี้ ได้รับยกเว้น ไม่ต้องได้รับใบอนุญาตให้มี ใช้ซึ่งเครื่องวิทยุคมนาคมหรือตั้งสถานีวิทยุคมนาคมตามประกาศ กสทช. เรื่อง เครื่องวิทยุคมนาคม และสถานีวิทยุคมนาคมที่ได้รับยกเว้นไม่ต้องได้รับใบอนุญาตวิทยุคมนาคมตามพระราชบัญญัติวิทยุคมนาคม พ.ศ. 2498



nanb. | โทรคมนาคม
กำกับดูแลเพื่อประชาชน
Call Center 1200 (InSW5)

OGL3051276L

For Israel

הצהרת התאמה לתקני התקשורת
מכשירי רדיו מבוססים על אריווה המוגנת על ידי פטנט ירושלים מדינת ישראל, כחלק מהפרוייקט "כוכב" - לא כולל התקנת חללי התקנה למכשירי רדיו אחרות המוגנות כ"כ".
ג. רישום פטנט בידי משרד המבחן של מדינת ישראל, המיוזם על ידי משרד התעשייה והמסחר.
א. אזור התעשייה, את האמצעים התקשורת של המכשיר, ולא לעשות בו כל שינוי טכני אחר.
תקן מספר : 63-67459

א. הישגת במחשיר זה על בסיס "פטנט" מספר 17000143 הפעולה האוטו-
בלתי-לא תגלו התפרקות חללי הפירוק למערכת אחת הפועלת כ"כ.
ב. רישום "בדיקה" שלישית עשוי של הקול, בלבד, הגדר מספר תחנות הפעולה האוטו-
בלתי-תלויה "בדיקה" ל"מדינת ישראל" משרד התעשייה והמסחר.
ד. אזור התעשייה את האמצעים המוגנות של המכשיר, ולא לעשות בו כל שינוי טכני אחר.
ה. האזור הג"ל תקנה ארץ ארץ צדד האוטו, הפועל "operating frequencies of the device"
בתחום תדרים של
הספק התדרים של אס עולה על "output power of the device"

OGL3051277L

For Brazil



XXXXX-XX-XXXXX
13265-20-12227

OCCV051233L

OCCV051234L

Este equipamento opera em caráter secundário, isto é, não tem direito à proteção contra interferência prejudicial, mesmo de estações do mesmo tipo, e não pode causar interferência a sistemas operando em caráter primário.

For Taiwan



CCAF20LP2330T5

電信法第 4B 條, 低功率電波輻射性電機管理辦法
第十二條

經型式認證合格之低功率射頻電機, 非經許可, 公司、商號或使用者均不得擅自變更頻率, 加大功率或變更原設計之特性及功能。

第十四條

低功率射頻電機之使用不得影響飛航安全及干擾合法通信; 經發現有干擾現象時, 應立即停用, 並改善至無干擾時方得繼續使用。

前項合法通信, 指依電信法規定作業之無線電通信。低功率射頻電機須忍受合法通信或工業、科學及醫療用電波輻射性電機設備之干擾。

Article 12

Without permission, any company, firm or user shall not alter the frequency, increase the power, or change the characteristics and functions of the original design of the certified lower power frequency electric machinery.

Article 14

The application of low power frequency electric machineries shall not affect the navigation safety nor interface a legal communication, if an interference is found, the service will be suspended until improvement is made and the interference no longer exist.

OCV051235L

For UAE



For Jordan

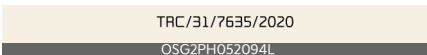

For Australia



For United Kingdom



For Morocco



For Indonesia



For Pakistan



For Senegal



For Oman

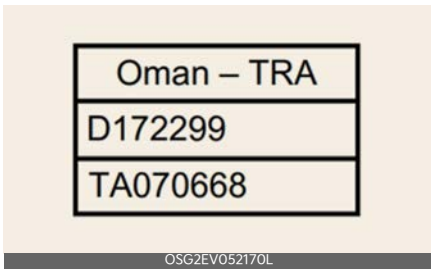

For Nigeria

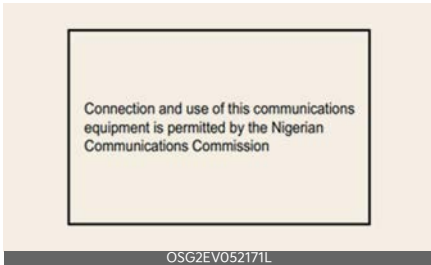

For Zambia



Economical operation

Your vehicle's fuel economy depends mainly on your style of driving, where you drive and when you drive.

Each of these factors affects how many kilometers (miles) you can get from a liter (gallon) of fuel. To operate your vehicle as economically as possible, use the following driving suggestions to help save money in both fuel and repairs:

- Drive smoothly.
- Drive at a moderate speed.
- Take care of your tires.
- Be sure that the wheels are aligned correctly.
- Maintain your vehicle in accordance with the maintenance schedule.
- Don't carry unnecessary weight in your vehicle.
- Don't let the engine idle longer than necessary.
- Don't "lug" or "over-rev" the engine.
- Don't open the windows at high speeds.
- Slow down when driving in crosswinds and headwinds.

WARNING

Never turn off the vehicle to coast down hills or anytime the vehicle is in motion. The power steering and power brakes will not function properly with turning off the vehicle. In addition, turning off the vehicle while driving could make the steering wheel heavy due to the power steering system not operating, turn the steering wheel stronger than usual.

Special driving conditions

If driving conditions deteriorate due to poor weather or road conditions, you should pay even more attention than usual.

Hazardous driving conditions

When hazardous driving conditions are encountered such as water, snow, ice, mud, sand, or similar hazards, follow these suggestions:

- Drive cautiously and allow extra distance for braking.
- Avoid sudden braking or steering.
- Do not pump the brake pedal on a vehicle equipped with ABS.
- If stalled in snow, mud, or sand, use the second gear. Accelerate slowly to avoid spinning the drive wheels.
- Use sand, rock salt, or other nonslip material under the drive wheels to provide traction when stalled in ice, snow, or mud.

Reducing the risk of a rollover

This multi-purpose passenger vehicle is defined as a Sports Utility Vehicle (SUV). Utility vehicles have a significantly higher rollover rate than other types of vehicles. SUVs have higher ground clearance and a narrower track to make them capable of performing in a wide variety of offroad applications.

Specific design characteristics give them a higher center of gravity than ordinary vehicles. An advantage of the higher ground clearance is a better view of the road, which allows you to anticipate problems.

They are not designed for cornering at the same speeds as conventional passenger vehicles, any more than low-

slung sports vehicles are designed to perform satisfactorily in off-road conditions. Due to this risk, driver and passengers are strongly recommended to buckle their seat belts.

In a rollover crash, an unbelted person is significantly more likely to die than a person wearing a seat belt. There are steps that a driver can make to reduce the risk of a rollover.

If at all possible, avoid sharp turns or abrupt maneuvers, do not load your roof rack with heavy cargo, and never modify your vehicle in any way.

WARNING

- Your vehicle is equipped with tires designed to provide safe ride and handling capability. Do not use tires and wheels that are different in size and type from the originally installed ones. It can affect the safety and performance of your vehicle, which could lead to steering failure or rollover and serious injury. When replacing the tires, be sure to equip all four tires with the tire and wheel of the same size, type, tread, brand and load-carrying capacity.
- As with other Sports Utility Vehicle (SUV), failure to operate this vehicle correctly may result in loss of control, an accident or vehicle rollover.
 - Utility vehicles have a significantly higher rollover rate than other types of vehicles.
 - Specific design characteristics (higher ground clearance, narrower track, etc.) give this vehicle a higher center of gravity than ordinary vehicles.
 - A SUV is not designed for cornering at the same speeds as conventional vehicles.

- Avoid sharp turns or abrupt maneuvers.
- In a rollover crash, an unbelted person is significantly more likely to die than a person wearing a seat belt. Make sure everyone in the vehicle is properly buckled up.

Rocking the vehicle

If it is necessary to rock the vehicle to free it from snow, sand, or mud, first turn the steering wheel right and left to clear the area around your front wheels. Then, shift back and forth between R (Reverse) and any forward gear.

Do not race the engine, and spin the wheels as little as possible. If you are still stuck after a few tries, have the vehicle pulled out by a tow vehicle to avoid engine overheating and possible damage to the transmission.

WARNING

Do not attempt to rock the vehicle if people or objects are nearby. The vehicle may suddenly move forward or backwards as it becomes unstuck.

CAUTION

- Prolonged rocking may cause vehicle overheating, transmission damage or failure, and tire damage.
- Do not spin the wheels, especially at speeds more than 56 km/h (35 mph). Spinning the wheels at high speeds when the vehicle is stationary could overheat and damage tires, and the rotating wheels may fly away and injure bystanders.

*** NOTICE**

The Electronic Stability Control (ESC) should be turned OFF prior to rocking the vehicle.

Smooth cornering

Avoid braking or gear changing in corners, especially when roads are wet. Ideally, corners should always be taken under gentle acceleration. If you follow these suggestions, tire wear will be held to a minimum.

Driving at night

Because night driving presents more hazards than driving in the daylight, here are some important tips to remember:

- Slow down and keep more distance between you and other vehicles, as it may be more difficult to see at night, especially in areas where there may not be any street lights.
- Adjust your mirrors to reduce the glare from other driver's headlights.
- Keep your headlights clean and properly aimed. (On vehicles not equipped with the automatic headlight aiming feature.) Dirty or improperly aimed headlights will make it much more difficult to see at night.
- Avoid staring directly at the headlights of oncoming vehicles. You could be temporarily blinded, and it will take several seconds for your eyes to readjust to the darkness.

Driving in the rain

Rain and wet roads can make driving dangerous, especially if you're not prepared for the slick pavement.

Here are a few things to consider when driving in the rain:

- A heavy rainfall will make it harder to see and will increase the distance needed to stop your vehicle, so slow down.
- Keep your windshield wiping equipment in good shape. Replace your windshield wiper blades when they show signs of streaking or missing areas on the windshield.
- If your tires are not in good condition, making a quick stop on wet pavement can cause a skid and possibly lead to an accident. Be sure your tires are in good shape.
- Turn on your headlights to make it easier for others to see you.
- Driving too fast through large puddles can affect your brakes. If you must go through puddles, try to drive through them slowly.
- If you believe you may have gotten your brakes wet, apply them lightly while driving until normal braking operation returns.

Hydroplaning

If the road is wet enough and you are going fast enough, your vehicle may have little or no contact with the road surface and actually ride on the water. The best advice is SLOW DOWN when the road is wet.

The risk of hydroplaning increases as the depth of tire tread decreases, refer to "Tire replacement" on page 8-39.

Driving in flooded areas

Avoid driving through flooded areas unless you are sure the water is no higher than the bottom of the wheel hub. Drive through any water slowly. Allow adequate stopping distance because brake performance may be affected.

After driving through water, dry the brakes by gently applying them several times while the vehicle is moving slowly.

Driving off-road

Drive carefully off-road because your vehicle may be damaged by rocks or roots of trees. Become familiar with the off-road conditions where you are going to drive before you begin driving.

Highway driving

Tires

Adjust the tire inflation pressures to specification. Low tire inflation pressures will result in overheating and possible failure of the tires.

Avoid using worn or damaged tires which may result in reduced traction or tire failure.

Never exceed the maximum tire inflation pressure shown on the tires.

WARNING

- Always check the tires for proper inflation before driving. Underinflated or overinflated tires can cause poor handling, loss of vehicle control, and sudden tire failure, leading to accidents, injuries, and even death. For proper tire pressures, refer to "Tires and wheels" on page 9-5.

- Always check the tire tread before driving your vehicle. Worn-out tires can result in loss of vehicle control. Worn-out tires should be replaced as soon as possible. For further information and tread limits, refer to "Tires and wheels" on page 8-37.

Fuel, engine coolant and engine oil

High speed travel consumes more fuel than urban motoring. Do not forget to check both the engine coolant and engine oil.

Drive belt

A loose or damaged drive belt may result in overheating of the engine.

Winter driving

Severe weather conditions in the winter result in greater wear and other problems.

To minimize the problems of winter driving, you should follow these suggestions:

- * Snow tires and tire chains for the national language (Icelandic) see the Appendix.

Snowy or icy conditions

To drive your vehicle in deep snow, it may be necessary to use snow tires or to install tire chains on your tires.

If snow tires are needed, it is necessary to select tires equivalent in size and type of the original equipment tires. Failure to do so may adversely affect the safety and handling of your vehicle. Furthermore, speeding, rapid acceleration, sudden brake applications, and sharp turns are potentially very hazardous practices.

During deceleration, use vehicle braking to the fullest extent. Sudden brake applications on snowy or icy roads may cause skids to occur. You need to keep sufficient distance between the vehicle in operation in front of your vehicle. Also, apply the brake gently. It should be noted that installing tire chains on the tire will provide a greater driving force, but will not prevent side skids.

Tire chains are not legal in all states. Check state laws before fitting tire chains.

Snow tires

If you mount snow tires on your vehicle, make sure they are radial tires of the same size and load range as the original tires. Mount snow tires on all four wheels to balance your vehicle's handling in all weather conditions. Keep in mind that the traction provided by snow tires on dry roads may not be as high as your vehicle's original equipment tires. You should drive cautiously even when the roads are clear. Check with the tire dealer for maximum speed recommendations.

Do not install studded tires without first checking local, state and municipal regulations for possible restrictions against their use.

⚠ WARNING

Snow tires should be equivalent in size and type to the vehicle's standard tires. Otherwise, the safety and handling of your vehicle may be adversely affected.

Tire chains

wire-type



OSG2H051096

fabric-type



OSG2H051097

Since the sidewalls of radial tires are thinner, they can be damaged by mounting some types of snow chains on them. Therefore, the use of snow tires is recommended instead of snow chains. Do not mount tire chains on vehicles equipped with aluminum wheels; snow chains may cause damage to the wheels. If snow chains must be used, use fabric-type chains or wire-type chains with a thickness of less than 12 mm (0.47 inch).

Damage to your vehicle caused by improper snow chain use is not covered by your vehicle manufacturer's warranty.

When using tire chains, attach them to the drive wheels as follows.

- Front wheel drive vehicle moves the front wheel as a power source. Thus, snow chains must be mounted to front tires.
- After mounting snow chains, drive slowly. If you hear noise caused by chains contacting the body, slow down until the noise stops and remove the chain as soon as you begin driving on cleared roads to prevent damage.
- Wrong size chains or improperly installed chains can damage your vehicle's brake lines, suspension, body and wheels. Therefore, when installing snow chain, follow the manufacturer's instructions and mount them as tightly possible. Drive slowly (less than 30 km/h (20 mph)) with chains installed.

⚠ CAUTION

- Make sure the snow chains are the correct size and type for your tires. Incorrect snow chains can cause damage to the vehicle body and suspension and may not be covered by your

vehicle manufacturer warranty. Also, the snow chain connecting hooks may be damaged from contacting vehicle components causing the snow chains to come loose from the tire. Make sure the snow chains are SAE class "S" certified.

- Always check chain installation for proper mounting after driving approximately 0.5 to 1 km (0.3 to 0.6 miles) to ensure safe mounting. Retighten or remount the chains if they are loose.
- Fabric-type chains must be used on the vehicle with 18 inches (225/45R18) tires.

Use high quality ethylene glycol coolant

Your vehicle is delivered with high quality ethylene glycol coolant in the cooling system. It is the only type of coolant that should be used because it helps prevent corrosion in the cooling system, lubricates the water pump and prevents freezing. Be sure to replace or replenish your coolant in accordance with the maintenance schedule in section 8.

Before winter, have your coolant tested to assure that its freezing point is sufficient for the temperatures anticipated during the winter.

Check battery and cables

Winter puts additional burdens on the battery system. Visually inspect the battery and cables as described in section 8. Have the level of charge in your battery checked by a professional workshop. Kia recommends to visit an authorized Kia dealer/service partner.

Change to "winter weight" oil if necessary

In some climates it is recommended that a lower viscosity "winter weight" oil be used during cold weather. See "Recommended lubricants and capacities" on page 9-6. If you aren't sure what weight oil you should use, Kia recommends to consult an authorized Kia dealer/service partner.

Check spark plugs and ignition system

Inspect your spark plugs as described in "Scheduled maintenance service" on page 8-9 and replace them if necessary. Also check all ignition wiring and components to be sure they are not cracked, worn or damaged in any way.

To keep locks from freezing

To keep the locks from freezing, squirt an approved de-icer fluid or glycerine into the key opening. If a lock is covered with ice, squirt it with an approved de-icing fluid to remove the ice. If the lock is frozen internally, you may be able to thaw it out by using a heated key. Handle the heated key with care to avoid injury.

Use approved window washer anti-freeze in system

To keep the water in the window washer system from freezing, add an approved window washer anti-freeze solution in accordance with instructions on the container. Window washer anti-freeze is available from an authorized Kia dealer/service partner and most auto parts outlets. Do not use engine coolant or other

types of anti-freeze as these may damage the paint finish.

Don't let your parking brake freeze

Under some conditions your parking brake can freeze in the engaged position. This is most likely to happen when there is an accumulation of snow or ice around or near the rear brakes or if the brakes are wet. If there is a risk the parking brake may freeze, temporarily apply it with the gear in P (Park). Also, block the rear wheels in advance, so the vehicle may not roll. Then release the parking brake.

Don't let ice and snow accumulate underneath

Under some conditions, snow and ice can build up under the fenders and interfere with the steering. When driving in severe winter conditions where this may happen, you should periodically check underneath the vehicle to be sure the movement of the front wheels and the steering components is not obstructed.

Carry emergency equipment

Depending on the severity of the weather, you should carry appropriate emergency equipment. Some of the items you may want to carry include tire chains, tow straps or chains, flashlight, emergency flares, sand, shovel, jumper cables, window scraper, gloves, ground cloth, coveralls, blanket, etc.

Drive your vehicle when water vapor condenses and accumulates inside the exhaust pipes

When the vehicle is stopped for a long time in winter while the engine is running, water vapor may condense and accumulate inside the exhaust pipes. Water in the exhaust pipes may cause noise, etc., but it is drained driving at medium to high speed.

Trailer towing (if equipped)

If you are considering towing with your vehicle, you should first check with your country's Department of Motor Vehicles to determine their legal requirements.

Since laws vary the requirements for towing trailers, cars, or other types of vehicles or apparatus may differ. Kia recommends to ask an authorized Kia dealer/service partner.

Your vehicle can tow a trailer. To identify what the vehicle trailering capacity is for your vehicle, refer to "Weight of the trailer" on page 6-186 that appears later in this section.

Remember that trailering is different than just driving your vehicle by itself. Trailering means changes in handling, durability, and fuel economy. Successful, safe trailering requires correct equipment, and it has to be used properly.

This section contains many timetested, important trailering tips and safety rules. Many of these are important for your safety and that of your passengers. Please read this section carefully before you pull a trailer.

Load-pulling components such as the engine, transmission, wheel assemblies, and tires are forced to work harder against the load of the added weight. The engine is required to operate at relatively higher speeds and under greater loads. This additional burden generates extra heat. The trailer also considerably adds wind resistance, increasing pulling requirements.

WARNING

- If you don't use the correct equipment and drive improperly, you can lose control when you pull a trailer. For example, if the trailer is too heavy, the

brakes may not work well - or even at all. You and your passengers could be seriously or fatally injured. Pull a trailer only if you have followed all the steps in this section.

- Before towing, make sure the total trailer weight, gross combination weight, gross vehicle weight, gross axle weight and trailer tongue load are all within the limits.

⚠ CAUTION

Pulling a trailer improperly can damage your vehicle and result in costly repairs not covered by your warranty. To pull a trailer correctly, follow the advice in this section.

*** NOTICE**

- The mounting hole for hitches are located on both sides of the underbody behind the rear tires.
- **For Europe**
 - The technically permissible maximum load on the rear axle(s) may be exceeded by not more than 15% and the technically permissible maximum laden mass of the vehicle may be exceeded by not more than 10% or 100 kg (220.4 lbs), whichever value is lower. In this case, do not exceed 100 km/h (62.1 mph) for vehicle of category M1 or 80 km/h (49.7 mph) for vehicle of category N1.
 - When towing a trailer, the additional load imposed at the trailer coupling device may cause the rear tire maximum load ratings to be exceeded, but not by more than 15%. In such a case, do not exceed 100km/h, and the rear tire pressure

should be at least 20 kPa(0.2 bar) above the tire pressure(s) as recommended for normal use (i.e. without a trailer attached).

Hitches

It's important to have the correct hitch equipment. Crosswinds, large trucks going by, and rough roads are a few reasons why you'll need the right hitch. Here are some rules to follow:

- Do you have to make any holes in the body of your vehicle when you install a trailer hitch? If you do, then be sure to seal the holes later when you remove the hitch.

If you don't seal them, deadly carbon monoxide (CO) from your exhaust can get into your vehicle, as well as dirt and water.

- The bumpers on your vehicle are not intended for hitches. Do not attach rental hitches or other bumper-type hitches. Use only a frame-mounted hitch that does not attach to the bumper.
- Any part of the rear number plate or lighting devices of the vehicle must not be obscured by the mechanical coupling device.

If the rear number plate and/or lighting devices can be obscured partially by any part of the mechanical coupling device, mechanical coupling devices that can not be easily removed or repositioned without use of any tools, except an easily operated (i.e. an effort not exceeding 20 Nm) release key which is supplied by the manufacturer of the coupling device, are not permitted for use.

Please note that the mechanical coupling device that is fitted and not in

use must always be removed or repositioned if the rear number plate and/or rear lighting devices are obscured by any part of the mechanical coupling device.

- Kia trailer hitch accessory is available at an authorized Kia dealer/service partner.

Safety chains

You should always attach chains between your vehicle and your trailer. Cross the safety chains under the tongue of the trailer so that the tongue will not drop to the road if it becomes separated from the hitch.

Instructions about safety chains may be provided by the hitch manufacturer or by the trailer manufacturer. Follow the manufacturer's recommendation for attaching safety chains. Always leave just enough slack so you can turn with your trailer. And, never allow safety chains drag on the ground.

Trailer brakes

If your trailer is equipped with a braking system, make sure it conforms to your country's regulations and that it is properly installed and operating correctly.

If your trailer weighs more than the maximum trailer weight without trailer brakes loaded, then it needs its own brakes and they must be adequate. Be sure to read and follow the instructions for the trailer brakes so you'll be able to install, adjust and maintain them properly.

- Don't tap into your vehicle's brake system.

WARNING

Do not use a trailer with its own brakes unless you are absolutely certain that you have properly set up the brake system. This is not a task for amateurs. Use an experienced, competent trailer shop for this work.

Driving with a trailer

Towing a trailer requires a certain amount of experience. Before setting out for the open road, you must get to know your trailer. Acquaint yourself with the feel of handling and braking with the added weight of the trailer. And always keep in mind that the vehicle you are driving is now a good deal longer and not nearly so responsive as your vehicle is by itself.

Before you start, check the trailer hitch and platform, safety chains, electrical connector(s), lights, tires and mirror adjustment. If the trailer has electric brakes, start your vehicle and trailer moving and then apply the trailer brake controller by hand to be sure the brakes are working. This lets you check your electrical connection at the same time.

During your trip, check occasionally to be sure that the load is secure, and that the lights and trailer brakes are still working.

Following distance

Stay at least twice as far behind the vehicle ahead as you would when driving your vehicle without a trailer. This can help you avoid situations that require heavy braking and sudden turns.

Passing

You'll need more passing distance up ahead when you're towing a trailer. And, because of the increased vehicle length, you'll need to go much farther beyond the passed vehicle before you can return to your lane.

Backing up

Hold the bottom of the steering wheel with one hand. Then, to move the trailer to the left, just move your hand to the left. To move the trailer to the right, move your hand to the right. Always back up slowly and, if possible, have someone guide you.

Making turns

When you're turning with a trailer, make wider turns than normal. Do this so your trailer won't strike soft shoulders, curbs, road signs, trees, or other objects. Avoid jerky or sudden maneuvers. Signal well in advance.

Turn signals when towing a trailer

When you tow a trailer, your vehicle has to have a different turn signal flasher and extra wiring. The green arrows on your instrument panel will flash whenever you signal a turn or lane change. Properly connected, the trailer lights will also flash to alert other drivers you're about to turn, change lanes, or stop.

When towing a trailer, the green arrows on your instrument panel will flash for turns even if the bulbs on the trailer are burned out. Thus, you may think drivers behind you are seeing your signals when, in fact, they are not. It's important to check occasionally to be sure the

trailer bulbs are still working. You must also check the lights every time you disconnect and then reconnect the wires.

Do not connect a trailer lighting system directly to your vehicle's lighting system. Use only an approved trailer wiring harness.

Have yourself assisted by a professional workshop in installing the wiring harness.

Kia recommends to visit an authorized Kia dealer/service partner.

WARNING

Failure to use an approved trailer wiring harness could result in damage to the vehicle electrical system and/or personal injury.

Driving on grades

Reduce the speed and shift to a lower gear before you start down a long or steep downgrade. If you don't shift down, you might have to use your brakes so much that they would get hot and no longer operate efficiently.

On a long uphill grade, shift down and reduce your speed to around 70 km/h (45 mph) to reduce the possibility of engine and transmission overheating.

CAUTION

- When towing a trailer on steep grades (in excess of 6%) pay close attention to the engine coolant temperature gauge to ensure the engine does not overheat. If the needle of the coolant temperature gauge moves across the dial towards "H (HOT) (or 130 °C/260 °F)", pull over and stop as soon as it is safe to do so, and allow the engine to idle until it cools down. You may pro-

ceed once the engine has cooled sufficiently.

- You must decide the driving speed depending on trailer weight and uphill grade to reduce the possibility of engine and transmission overheating.

Parking on hills

Generally, if you have a trailer attached to your vehicle, you should not park your vehicle on a hill. People can be seriously or fatally injured, and both your vehicle and the trailer can be damaged if unexpectedly roll down hill.

However, if you ever have to park your trailer on a hill, here's how to do it:

1. Pull the vehicle into the parking space. Turn the steering wheel in the direction of the curb (right if headed down hill, left if headed up hill).
2. Set the parking brake and shut off the vehicle.
3. Place chocks under the trailer wheels on the down hill side of the wheels.
4. Start the vehicle, hold the brakes, shift to neutral, release the parking brake and slowly release the brakes until the trailer chocks absorb the load.
5. Reapply the brakes, reapply the parking brake.
6. Shut off the vehicle and release the vehicle brakes but leave the parking brake set.

WARNING

- Parking your vehicle on a hill with a trailer attached could cause serious injury or death, should the trailer break loose.
- It can be dangerous to get out of your vehicle if the parking brake is not firmly set. If you have left the engine

running, the vehicle can move suddenly. You or others could be seriously or fatally injured.

When you are ready to leave after parking on a hill

1. Apply your brakes and hold the brake pedal down while you:
 - Start your engine;
 - Shift into gear; and
 - Release the parking brake.
2. Slowly remove your foot from the brake pedal.
3. Drive slowly until the trailer is clear of the chocks.
4. Stop and have someone pick up and store the chocks.

Maintenance when trailer towing

Your vehicle will need service more often when you regularly pull a trailer. Important items to pay particular attention to include engine oil, axle lubricant and cooling system fluid. Brake condition is another important item to frequently check. Each item is covered in this manual, and the Index will help you find them quickly. If you're trailering, it's a good idea to review these sections before you start your trip.

Don't forget to also maintain your trailer and hitch. Follow the maintenance schedule that accompanied your trailer and check it periodically. Preferably, conduct the check at the start of each day's driving. Most importantly, all hitch nuts and bolts should be tight.

⚠ CAUTION

- Due to higher load during trailer usage, overheating might occur in hot days or during uphill driving. If the coolant gauge indicates overheating, switch off the A/C and stop the vehicle in a safe area to cool down the engine.
 - When towing, check the transmission fluid more frequently.
 - If your vehicle is not equipped with an air conditioner, you should install a condenser fan to improve engine performance when towing a trailer.
-

If you do decide to pull a trailer

Here are some important points if you decide to pull a trailer:

- Consider using a sway control. You can ask a hitch dealer about sway control.
- Do not do any towing with your vehicle during its first 2,000 km (1,200 miles) in order to allow the engine to properly break in. Failure to heed this caution may result in serious engine or transmission damage.
- When towing a trailer, Kia recommends that you consult an authorized Kia dealer/service partner on additional requirements such as a towing kit, etc.
- Always drive your vehicle at a moderate speed (less than 100 km/h (60 mph)).
- On a long uphill grade, do not exceed 70 km/h (45 mph) or the posted towing speed limit, whichever is lower.
- The chart contains important considerations that have to do with weight:

Reference weight and distance when towing a trailer

Item		Smartstream G1.6 GDI HEV	Smartstream G1.6 GDI PHEV
		DCT	DCT
Maximum trailer weight	With brake system	1,300 kg (2,866 lbs.)	
	Without brake system	600 kg (1,323 lbs.)	
Maximum permissible static vertical load on the coupling device		100 kg (220 lbs.)	
Recommended distance from rear wheel center to coupling point		880 mm (34.6 inch)	

Weight of the trailer

What is the maximum safe weight of a trailer? It should never weigh more than the maximum trailer weight with trailer brakes. But even that can be too heavy. It depends on how you plan to use your trailer. For example, speed, altitude, road grades, outside temperature and how often your vehicle is used to pull a trailer are all important. The ideal trailer weight can also depend on any special equipment that you have on your vehicle.

Weight of the trailer tongue

The tongue load of any trailer is an important weight to measure because it affects the total gross vehicle weight (GVW) of your vehicle. This weight includes the curb weight of the vehicle, any cargo you may carry in it, and the people who will be riding in the vehicle. And if you tow a trailer, you must add the tongue load to the GVW because your vehicle will also be carrying that weight.

The trailer tongue should weigh a maximum of 10% of the total loaded trailer weight, within the limits of the maximum trailer tongue load permissible.

After you've loaded your trailer, weigh the trailer and then the tongue, separately, to see if the weights are proper. If

they aren't, you may be able to correct them simply by moving some items around in the trailer.

WARNING

- Never load a trailer with more weight in the rear than in the front. The front should be loaded with approximately 60% of the total trailer load; the rear should be loaded with approximately 40% of the total trailer load.
- Never exceed the maximum weight limits of the trailer or trailer towing equipment. Improper loading can result in damage to your vehicle and/or personal injury. Check weights and loading at a commercial scale or highway patrol office equipped with scales.
- An improperly loaded trailer can cause loss of vehicle control.

NOTICE

With increasing altitude the engine performance decreases. From sea level for every 1,000 m, 10% of vehicle/trailer weight (trailer weighter + gross vehicle weight) must be deducted.

If the battery SOC is very low, the vehicle may not be able to launch. Please charge the battery before you drive.

Vehicle weight

This section will guide you in the proper loading of your vehicle, to keep your loaded vehicle weight within its design rating capability. Properly loading your vehicle will provide maximum return of the vehicle design performance. Before loading your vehicle, familiarize yourself with the following terms for determining your vehicle's weight ratings, from the vehicle's specifications and the certification label:

Base curb weight

This is the weight of the vehicle including a full tank of fuel and all standard equipment. It does not include passengers, cargo, or optional equipment.

Vehicle curb weight

This is the weight of your new vehicle when you picked it up from your dealer plus any aftermarket equipment.

Cargo weight

This figure includes all weight added to the Base Curb Weight, including cargo and optional equipment.

GAW (Gross axle weight)

This is the total weight placed on each axle (front and rear) - including vehicle curb weight and all payload. (if equipped)

GAWR (Gross axle weight rating)

This is the maximum allowable weight that can be carried by a single axle (front or rear). These numbers are shown on the certification label.

The total load on each axle must never exceed its GAWR.

GVW (Gross vehicle weight)

This is the Base Curb Weight plus actual Cargo Weight plus passengers.

GVWR (Gross vehicle weight rating)

This is the maximum allowable weight of the fully loaded vehicle (including all options, equipment, passengers and cargo). The GVWR is shown on the certification label located on the driver's (or front passenger's) door sill. (if equipped)

Overloading

Vehicle weight

The gross axle weight rating (GAWR) and the gross vehicle weight rating (GVWR) for your vehicle are on the certification label attached to the driver's (or front passenger's) door. Exceeding these ratings can cause an accident or vehicle damage. You can calculate the weight of your load by weighing the items (and people) before putting them in the vehicle. Be careful not to overload your vehicle.

Loading Your Vehicle - For Australia (if equipped)

Certification Label



Tire Label



The Certification/Tire label is found on the front edge of the RH (or LH) "B" pil-

lar. The label shows the size of your original tires and inflation pressures needed to obtain the gross weight capacity of your vehicle.

This is called the GVWR (Gross Vehicle Weight Rating). The GVWR includes the weight of the vehicle, all occupants and cargo. The Certification/Tire label also tells you the maximum weights for the front and rear axles, called Gross Axle Weight Rating (GAWR).

Never exceed the GVWR for your vehicle, or the Gross Axle Weight Rating (GAWR) for either the front or rear axle. And, if you do have a heavy load, you should spread it out.

Your warranty does not cover parts or components that fail because of overloading.

Do not load your vehicle any heavier than the GVWR or the maximum front and rear GAWRs. If you do, change to the vehicle may occur, or it can change the way your vehicle handles. These could cause you to lose control. Also, overloading can shorten the life of your vehicle.

What to do in an emergency

Road warning	7-3
• Hazard warning flasher.....	7-3
In case of an emergency while driving	7-3
• If the vehicle stalls while driving.....	7-3
• If the engine stalls at a crossroad or crossing.....	7-3
• If you have a flat tire while driving.....	7-3
If the engine does not start	7-4
• If engine does not turn over or turns over slowly.....	7-4
• If engine turns over normally but does not start.....	7-4
Emergency starting	7-5
• Before jump starting (for hybrid vehicle).....	7-5
• Jump-starting.....	7-6
• Push-starting.....	7-7
If the engine overheats	7-8
• Cooling down the vehicle.....	7-8
• If the cooling fan does not work.....	7-8
• If the coolant is running out.....	7-8
• If the water pump drive belt is broken.....	7-8
• If overheating happens again.....	7-8
Tire Pressure Monitoring System (TPMS)	7-9
• Low tire pressure telltale.....	7-10
• Tire Pressure Monitoring System (TPMS) malfunction indicator.....	7-11
• Changing a tire with TPMS.....	7-12
If you have a flat tire (with spare tire)	7-14
• Removing and storing the spare tire.....	7-14
• Changing tires.....	7-15
• Important - use of compact spare tire.....	7-17
• Jack label.....	7-18

7 What to do in an emergency

If you have a flat tire (with Tire Mobility Kit)	7-20
• Components of the Tire Mobility Kit	7-21
• Using the Tire Mobility Kit	7-22
• Distributing the sealant	7-22
• Checking tire inflation pressure	7-23
• Notes on the safe use of the Tire Mobility Kit	7-24
Towing.....	7-25
• Towing service	7-25
• Emergency towing.....	7-25
Emergency commodity	7-27
Pan-European eCall system	7-28
• Description of the ecall in-vehicle system	7-29
• Information on data processing	7-29
• Pan-European eCall System	7-31
UAE eCall system	7-33
• Description of the eCall in-vehicle system.....	7-34
• Information on data processing	7-34
• UAE eCall System	7-36

What to do in an emergency

Road warning

When in an emergency situation occurs while driving or when you park by the edge of the roadway, you must alert approaching or passing vehicles to be careful as they pass. For this, you should use the hazard warning flasher.

Hazard warning flasher

The hazard warning flasher serves as a warning to other drivers to exercise extreme caution when approaching, overtaking, or passing your vehicle.



OSG2H061001

Condition(s)

- When in an emergency situation occurs while driving
- Parking by the edge of the roadway

Operation

- Push the hazard warning flasher switch.

* INFORMATION

- The hazard warning flasher operates whether your vehicle is running or not.
- The turn signals do not work when the hazard flasher is on.
- Care must be taken when using the hazard warning flasher while the vehicle is being towed.

In case of an emergency while driving

If the vehicle stalls while driving

Operation

1. Reduce the speed and keep a straight line.
2. Stop the vehicle to a safe place.
3. Turn the hazard warning flasher on.
4. Start the vehicle again.

If the engine still does not start, contact a professional workshop or seek other qualified assistance. Kia recommends to call an authorized Kia dealer/service partner.

If the engine stalls at a crossroad or crossing

Operation

1. Change the gear to N (Neutral).
2. Push the vehicle to a safe place.

If you have a flat tire while driving

Operation

1. Reduce the speed slowly and keep a straight line.
2. Stop the vehicle to a safe leveled place away from traffic.
3. Turn the hazard warning flasher on.
4. Set the parking brake.
5. Change the gear to P (Parking).
6. Have all passengers get out of the vehicle away from traffic.

Refer to "If you have a flat tire (with spare tire) (if equipped)" on page 7-14 or "If you have a flat tire (with Tire Mobility Kit) (if equipped)" on page 7-20.

If the engine does not start

* INFORMATION

When the engine does not start, first check to see how much fuel there is and whether the battery is discharged.

If engine does not turn over or turns over slowly

Operation

1. Set the parking brake.
2. Change the gear to P (Park) or N (Neutral).
3. Check if the battery and starter connections are clean and tight.
 - The battery is discharged if the interior light dims or goes out when you start the vehicle.

⚠ WARNING

If the engine does not start, do not push or pull the vehicle to start it. This could result in a collision or cause other damage. In addition, push or pull starting may cause the catalytic converter to be overloaded and create a fire hazard.

* NOTICE

Do not start the vehicle by pulling or pushing. Refer to "Jump-starting" on page 7-6.

If engine turns over normally but does not start

Operation

1. Check the following:
 - Fuel level. Add fuel if necessary.
 - Ignition coils and spark plug connectors. Reconnect any that may be disconnected or loose.
 - Fuel line in the engine compartment.

If the engine still does not start, contact a professional workshop or seek other qualified assistance. Kia recommends to call an authorized Kia dealer/service partner.

Emergency starting

Before jump starting (for hybrid vehicle)

This vehicle does not have a regular 12V battery that needs periodic replacement. It is lithium ion polymer type integrated into the HEV high voltage battery. The vehicle has a 12V battery protection system that cuts 12V battery from vehicle draw to prevent full discharge.

Using the 12V battery reset switch



1. Press the 12V Battery Reset switch to reconnect the 12V battery.
2. Start the vehicle within 15 seconds of pressing the 12V Battery Reset switch.
3. After starting the vehicle (READY indicator on), operate the vehicle safely outdoors in ready mode stopped and/or drive it for 30 minutes total to charge the 12V battery fully.

If you do not start the vehicle immediately after pressing the 12V Battery Reset switch, the power of 12V battery is automatically disconnected after few seconds to save the 12V battery from additional discharge. If the 12V battery is disconnected prior to starting the vehicle, press the 12V Battery Reset switch again and then immediately start the vehicle as explained.

Repeated use of the 12V Battery Reset switch without a sufficient vehicle ON cycle (30 Min+) may cause over discharge of the 12V battery, which will pre-

vent the vehicle from starting. If the 12V battery is over discharged to a point that the reset does not work, try to jumpstart the vehicle.

* NOTICE

After starting the vehicle (READY indicator on), the 12V battery is being charged whether the engine is running or not. Although there is no engine sound, it is unnecessary to depress the accelerator pedal.

The following items may need to be reset after the battery has been discharged or the battery has been disconnected.

See chapter 4 and 5 for:

- Power Windows
- Trip Computer
- Climate Control System
- Audio System

* NOTICE

External power source using 12V battery

The use of external power accessories may reduce performance and function of the vehicle. Especially, the use of dash cameras may shut off the power of the vehicle prior to the dash camera's automatic shut-down.

If the power of the vehicle is shut off, start the vehicle as explained. (refer to "Using the 12V battery reset switch" on page 7-5)

Jump-starting



Condition(s)

- When the vehicle will not start due to low battery power, you may need to jump start the vehicle.

Operation

1. Turn off all unnecessary electrical loads.
2. Make sure the booster battery is 12-volt and that its negative terminal is grounded. If the booster battery is in another vehicle, do not allow the vehicles to come in contact.
3. Connect the jumper cables in the exact sequence shown in the illustration.
 - Connect one end of a jumper cable to the positive terminal of the discharged battery (1).
 - Connect the other end to the positive terminal of the booster battery (2).
 - Proceed to connect one end of the other jumper cable to the negative terminal of the booster battery (3), then the other end to a solid, stationary, metallic point away from the battery (4). Do not allow the

jumper cables to contact anything except the correct battery terminals or the correct ground. Do not lean over the battery when making connections.

4. If connected with the other vehicle, start the vehicle with the booster battery first and let it run at 2,000 rpm for several minutes.
5. For hybrid vehicle, press 12V BATT RESET button.
For plug-in hybrid vehicle, start the vehicle with the discharged battery.
6. If the vehicle starts, disconnect one end of the negative terminal of the booster battery (3), then other end of the positive terminal of the booster battery (2) and the discharged battery (1).

If the cause of your battery discharging is not apparent, you should have your vehicle checked by a professional workshop. Kia recommends to visit an authorized Kia dealer/service partner.

7. Let the vehicle run for at least approximately 30 minutes.

⚠ WARNING

Never attempt to check the electrolyte level of the battery as this may cause the battery to rupture or explode causing serious injury.

- Keep all flames or sparks away from the battery. The battery produces hydrogen gas which may explode if exposed to flame or sparks. If these instructions are not followed exactly, serious personal injury and damage to the vehicle may occur! If you are not sure how to follow this procedure, seek qualified assistance. Automobile batteries contain sulfuric acid. This is

poisonous and highly corrosive. When jump starting, wear protective glasses and be careful not to get acid on yourself, your clothing or on the vehicle.

- Do not attempt to jump start the vehicle if the discharged battery is frozen or if the electrolyte level is low; the battery may rupture or explode.
- Do not allow the (+) and (-) jumper cables to touch. It may cause sparks.
- The battery may rupture or explode when you jump start with a low or frozen battery.

CAUTION

- Use only a 12-volt jumper system. You can damage a 12-volt starting motor, ignition system, and other electrical parts beyond repair by use of a 24-volt power supply (either two 12-volt batteries in series or a 24-volt motor generator set).
- Do not connect the jumper cable from the negative terminal of the booster battery to the negative terminal of the discharged battery. This can cause the discharged battery to overheat and crack, releasing battery acid. Make sure to connect one end of the jumper cable to the negative terminal of the booster battery, and the other end to a metallic point, far away from the battery.

Push-starting

Vehicles equipped with dual clutch transmission cannot be push-started, and only jump-starting can be applied. Refer to "Jump-starting" on page 7-6.

WARNING

Never tow a vehicle to start it. When the engine starts, the vehicle can suddenly surge forward and could cause a collision with the tow vehicle.

If the engine overheats

* INFORMATION

When the temperature gauge indicates overheating, loss of power or a loud pinging, knocking noise will occur, being the engine too hot.

Cooling down the vehicle

Operation

1. Stop the vehicle to a safe place.
2. Turn the hazard warning flasher on.
3. Set the parking brake.
4. Change the gear to P (Park).
5. If the air conditioning is on, turn it off.
6. Check the following:
 - Engine cooling fan
 - Water pump drive belt
 - Belt tension
 - Leaks of the radiator, hoses or under the vehicle (If the air conditioning had been in use, it is normal for cold water to be draining from it when you stop).
7. Wait until the engine temperature returns normal.
8. Proceed with caution and keep an eye on further signs of overheating.

If the cooling fan does not work

Operation

- Stop the engine.

If the coolant is running out

Operation

1. Stop the engine.
2. Do not open the hood.
3. Wait until coolant has stopped running or the steam stops.
4. Add enough coolant to the reservoir.

If the water pump drive belt is broken

Operation

1. Stop the engine.
2. Contact a professional workshop or seek other qualified assistance. Kia recommends to call an authorized Kia dealer/service partner.

If overheating happens again

Operation

- Contact a professional workshop or seek other qualified assistance. Kia recommends to call an authorized Kia dealer/service partner.

⚠ WARNING



- While the engine is running, keep hair, hands and clothing away from the fan and drive belts to prevent injury.

- Do not remove the radiator cap when the engine is hot. This may result in coolant being blown out of the opening and cause serious burns.

CAUTION

- Serious loss of coolant indicates there is a leak in the cooling system and this should be checked as soon as possible by a professional workshop. Kia recommends to visit an authorized Kia dealer/service partner.
- When the engine overheats from low engine coolant, suddenly adding engine coolant may cause cracks in the engine. Add engine coolant slowly in small quantities to prevent damage.

Tire Pressure Monitoring System (TPMS) (if equipped)



- 1 Low tire pressure telltale /TPMS malfunction indicator
- 2 Low tire pressure position telltale (Shown on the LCD display)

Check tire pressure

- You can check the tire pressure in the assist mode on the cluster.
 - Refer to "LCD display modes" on page 5-54.
- Tire pressure is displayed 1~2 minutes later after driving.
- If tire pressure is not displayed when the vehicle is stopped, "Drive to display" message displays. After driving, check the tire pressure.
- You can change the tire pressure unit in the user settings mode on the cluster.
 - psi, kpa, bar (Refer to "User settings mode" on page 5-58.

Each tire, including the spare (if provided), should be checked monthly when cold and inflated to the inflation pressure recommended by the vehicle manufacturer on the vehicle placard or tire inflation pressure label.

(If your vehicle has tires of a different size than the size indicated on the vehicle placard or tire inflation pressure label, you should determine the proper tire inflation pressure for those tires.)

As an added safety feature, your vehicle has been equipped with a tire pressure monitoring system (TPMS) that appears a low tire pressure telltale when one or more of your tires is significantly under-inflated. Accordingly, when the low tire pressure telltale appears, you should stop and check your tires as soon as possible, and inflate them to the proper pressure. Driving on a significantly under-inflated tire causes the tire to overheat and can lead to tire failure. Under-inflation also reduces fuel efficiency and tire tread life, and may affect the vehicle's handling and stopping ability.

Please note that the TPMS is not a substitute for proper tire maintenance, and it is the driver's responsibility to maintain correct tire pressure, even if under-inflation has not reached the level to trigger illumination of the TPMS low tire pressure telltale.

Your vehicle has also been equipped with a TPMS malfunction indicator to indicate when the system is not operating properly. The TPMS malfunction indicator is combined with the low tire pressure telltale. When the system detects a malfunction, the telltale will flash for approximately 1 minute and then remain continuously appeared. This sequence will continue upon subsequent vehicle start-ups as long as the malfunction exists. When the TPMS malfunction indicator remains appeared after blinking for approximately 1 minute, the system may not be able to

detect or signal low tire pressure as intended.

TPMS malfunctions may occur for a variety of reasons, including the installation of replacement or alternate tires or wheels on the vehicle that prevent the TPMS from functioning properly. Always check the TPMS malfunction telltale after replacing one or more tires or wheels on your vehicle to ensure that the replacement or alternate tires and wheels allow the TPMS to continue to function properly.

*** NOTICE**

If any of the below happens, have the system checked by a professional workshop. Kia recommends to visit an authorized Kia dealer/service partner.

1. The low tire pressure telltale/ TPMS malfunction indicator do not appear for 3 seconds when the ignition switch is turned to the ON position or engine is running.
2. The TPMS malfunction indicator remains appeared after blinking for approximately 1 minute.
3. The Low tire pressure position telltale remains appeared.

Low tire pressure telltale (!)

Low tire pressure position telltale



A: Low tyre pressure

When the tire pressure monitoring system warning indicators are appeared

and warning message displayed on the cluster LCD display, one or more of your tires is significantly under-inflated. The low tire pressure position telltale light will indicate which tire is significantly under-inflated by appearing the corresponding position light.

If either telltale appears, immediately reduce your speed, avoid hard cornering and anticipate increased stopping distances. You should stop and check your tires as soon as possible. Inflate the tires to the proper pressure as indicated on the vehicle's placard or tire inflation pressure label located on the driver's side center pillar outer panel. If you cannot reach a service station or if the tire cannot hold the newly added air, replace the low pressure tire with a spare tire.

If you drive the vehicle for about 10 minutes at speeds above 25 km/h after replacing the low pressure tire with the spare tire, one of the following will happen:

- The TPMS malfunction indicator may blink for approximately 1 minute and then remain continuously appeared because the TPMS sensor is not mounted on the spare wheel.
(changed tire equipped with a sensor not in the vehicle)
- The TPMS malfunction indicator will remain continuously appeared while driving because the TPMS sensor is not mounted on the spare wheel.
(changed tire equipped with a sensor in the vehicle)

WARNING

Low pressure damage

Significantly low tire pressure makes the vehicle unstable and can contribute to loss of vehicle control and increased braking distances.

Continued driving on low pressure tires can cause the tires to overheat and fail.

CAUTION

- In winter or cold weather, the low tire pressure telltale may appear if the tire pressure was adjusted to the recommended tire inflation pressure in warm weather. It does not mean your TPMS is malfunctioning because the decreased temperature leads to a lowering of tire pressure.
- When you drive your vehicle from a warm area to a cold area or from a cold area to a warm area, or the outside temperature is higher or lower, you should check the tire inflation pressure and adjust the tires to the recommended tire inflation pressure.
- When filling tires with more air, conditions to turn off the low tire pressure telltale may not be met. This is because a tire inflator has a margin of error in performance. The low tire pressure telltale will be turned off if the tire pressure is above the recommended tire inflation pressure.

Tire Pressure Monitoring System (TPMS) malfunction indicator

The TPMS malfunction indicator will appear after it blinks for approximately one minute when there is a problem with the Tire Pressure Monitoring System. In this case, have the system checked by a professional workshop to determine the cause of the problem. Kia recommends to visit an authorized Kia dealer/service partner.

⚠ CAUTION

- The TPMS malfunction indicator may blink for approximately 1 minute and then remain continuously appeared if the vehicle is moving around electric power supply cables or radios transmitter such as at police stations, government and public offices, broadcasting stations, military installations, airports, or transmitting towers, etc. This can interfere with normal operation of the Tire Pressure Monitoring System (TPMS).
- The TPMS malfunction indicator may blink for approximately 1 minute and then remain continuously appeared if snow chains are used or some separate electronic devices such as notebook computer, mobile charger, remote starter or navigation etc., are used in the vehicle.
This can interfere with normal operation of the Tire Pressure Monitoring System (TPMS).

*** NOTICE**

If there is a malfunction with the TPMS, the low tire pressure position telltale will not be displayed even though the vehicle has an underinflated tire.

Changing a tire with TPMS

If you have a flat tire, the low Tire Pressure and Position telltales will come on. In this case, have the system checked by a professional workshop. Kia recommends to visit an authorized Kia dealer/service partner.

⚠ CAUTION

We recommend that you use the sealant approved by Kia.
The sealant on the tire pressure sensor and wheel shall be eliminated when you replace the tire with a new one.

Each wheel is equipped with a tire pressure sensor mounted inside the tire behind the valve stem. You must use TPMS specific wheels. Have your tires serviced by a professional workshop. Kia recommends to visit an authorized Kia dealer/service partner.

If you drive the vehicle for about 10 minutes at speeds above 25 km/h after replacing the low pressure tire with the spare tire, one of the following will happen:

- The TPMS malfunction indicator may blink for approximately 1 minute and then remain continuously appeared because the TPMS sensor is not mounted on the spare wheel. (changed tire equipped with a sensor not in the vehicle)
- The TPMS malfunction indicator will remain continuously appeared while driving because the TPMS sensor is not mounted on the spare wheel. (changed tire equipped with a sensor in the vehicle)

You may not be able to identify a low tire by simply looking at it. Always use a good quality tire pressure gauge to measure the tire's inflation pressure. Please note that a tire that is hot (from being driven) will have a higher pressure measurement than a tire that is cold (from sitting stationary for at least 3 hours and driven less than 1 mile (1.6 km) during that 3 hour period).

A cold tire means the vehicle has been sitting for 3 hours and driven for less than 1 mile (1.6 km) in that 3 hour period. Allow the tire to cool before measuring the inflation pressure. Always be sure the tire is cold before inflating to the recommended pressure.

WARNING

TPMS

- The TPMS cannot alert you to severe and sudden tire damage caused by external factors such as nails or road debris.
- If you feel any vehicle instability, immediately take your foot off the accelerator, apply the brakes gradually and with light force, and slowly move to a safe position off the road.

Protecting TPMS

Tampering with, modifying, or disabling the Tire Pressure Monitoring System (TPMS) components may interfere with the system's ability to warn the driver of low tire pressure conditions and/or TPMS malfunctions. Tampering with, modifying, or disabling the Tire Pressure Monitoring System (TPMS) components may void the warranty for that portion of the vehicle.

For EUROPE

- Do not modify the vehicle, it may interfere with the TPMS function.
- The wheels on the market do not have a TPMS sensor. For your safety, use parts for replacement from a professional workshop. Kia recommends to visit an authorized Kia dealer/service partner.
- If you use the wheels on the market, use a TPMS sensor approved by an authorized Kia dealer.

If your vehicle is not equipped with a TPMS sensor or TPMS does not work properly, you may fail the periodic vehicle inspection conducted in your country.

- All vehicles sold in the EUROPE market during below period must be equipped with TPMS.
- New model vehicle: Nov. 1, 2012 ~
- Current model vehicle: Nov. 1, 2014~ (Based on vehicle registrations)

CAUTION

We recommend that you use the sealant approved by Kia if your vehicle is equipped with a Tire Pressure Monitoring System. The liquid sealant can damage the tire pressure sensors.

If you have a flat tire (with spare tire) (if equipped)

Jack and tools



- 1 Jack handle
- 2 Jack
- 3 Wheel lug nut wrench

Removing and storing the spare tire

Operation

1. Remove the luggage board cover (1).



2. Turn the tire hold-down wing bolt counterclockwise.



3. Store the tire in the reverse order of removal. To prevent the spare tire and tools from "rattling" while the vehicle is in motion, store them properly.

⚠ WARNING

- Be cautious as the minimum ground clearance gets lower when you store the original tire in the bottom of the vehicle after replacing it with a spare tire. In particular, drive below 30 km/h (18 mph) when driving over a speed bump and on uphill/downhill/uneven road.
- Never attempt vehicle repairs in the traffic lanes of a public road or highway.
- Always move the vehicle completely off the road and onto the shoulder before trying to change a tire. The jack should be used on firm level ground. If you cannot find a firm level place off the road, call a towing service company for assistance.
- Be sure to use the correct front and rear jacking positions on the vehicle; never use the bumpers or any other part of the vehicle for jacking support.
- The vehicle can easily roll off the jack causing serious injury or death.
- Do not get under a vehicle that is supported by a jack.
- Do not start or run the engine while the vehicle is on the jack.
- Do not allow anyone remain in the vehicle while it is on the jack.
- Make sure any children present are in a secure place away from the road and from the vehicle to be raised with the jack.
- Ensure the spare tire retainer is properly aligned with the center of the spare tire to prevent the spare tire from "rattling". Otherwise, it may cause the spare tire to fall off the carrier and lead to an accident.

CAUTION

Check whether the tire hold-down wing bolt is fixed on the center of the tire wheel. If the tire hold-down wing bolt is not fixed securely, the tire may move around during driving and noise may sound.

Changing tires

Operation

1. Stop the vehicle to a safe leveled place away from traffic.



2. Turn the hazard warning flasher on.
3. Set the parking brake.
4. Change the gear to P and turn the vehicle off.
5. Remove the jack, wheel lug nut wrench and the spare tire from the vehicle.
6. Block both the front and rear of wheel that is diagonally opposite the jack position.



7. Loosen the wheel lug nuts counter-clockwise one turn each. Do not remove any wheel lug nuts until the tire has been raised off the ground.



8. Place the jack at the front (1) or rear (2) designated jacking positions. The jacking positions are plates that are welded to the frame with two tabs and a raised dot to index with the jack.

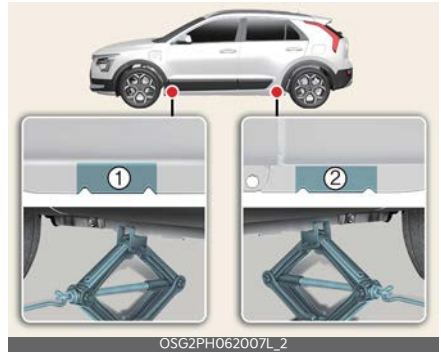

9. Insert the jack handle into the jack and turn it clockwise. Raise the vehicle until the tire just clears the ground. This measurement is approximately 30 mm (1.2 inches). Make sure the vehicle is stable and there is no chance for movement or slippage before removing the wheel lug nuts.



10. Loosen the wheel nuts and remove them by hand.
11. Slide the wheel off the studs and lay it flat so it does not roll away.

12. Pick up the spare tire, line up the holes with the studs and slide the wheel onto them. Tip the wheel slightly and get the top hole in the wheel lined up with the top stud. Jiggle the wheel back and forth until the wheel slides over the other studs.
13. Hold it on the studs, put the wheel nuts on the studs and tighten them by hand. Jiggle the tire to make sure it is completely seated.
14. Lower the vehicle to the ground by turning the jack handle counterclockwise.
15. Position the wheel lug nut wrench and tighten the wheel nuts. Be sure the socket is seated completely over the nut. Go around the wheel tightening every other nut until they are all tight. Double-check each nut for tightness.



After changing tires, have your vehicle checked by a professional workshop or seek other qualified assistance. Kia recommends to call an authorized Kia dealer/service partner.

⚠ WARNING

- To prevent vehicle movement while changing a tire, always set the parking brake fully, and always block the wheel diagonally opposite the wheel being changed.
- We recommend that the wheels of the vehicle be chocked, and that no person remain in a vehicle that is being jacked.

- To reduce the possibility of injury, be sure to use only the jack provided with the vehicle and in the correct jack position; never use any other part of the vehicle for jack support.
- Wheels may have sharp edges. Handle them carefully to avoid possible severe injury. Before putting the wheel into place, be sure that there is nothing on the hub or wheel (such as mud, tar, gravel, etc.) that interferes with the wheel from fitting solidly against the hub. If there is, remove it. If there is not good contact on the mounting surface between the wheel and hub, the wheel nuts could come loose and cause the loss of a wheel. Loss of a wheel may result in loss of control of the vehicle. This may cause serious injury or death.

Wheel lug nut tightening torque

- 11~13 kgf·m (79~94 lbf·ft)

*** INFORMATION**

If the pressure is lower than recommended, drive slowly to the nearest service station and inflate to the correct pressure. If it is too high, adjust it until it is correct.

⚠ CAUTION

Your vehicle has metric threads on the wheel studs and nuts. Make certain during wheel removal that the same nuts that were removed are reinstalled - or, if replaced, that nuts with metric threads and the same chamfer configuration are used. Installation of a non-metric thread nut on a metric stud or vice-versa will not secure the wheel to

the hub properly and will damage the stud so that it must be replaced.

Note that most lug nuts do not have metric threads. Be sure to use extreme care in checking for thread style before installing aftermarket lug nuts or wheels. If in doubt, consult a professional workshop. Kia recommends to consult an authorized Kia dealer/service partner.

WARNING

- If the studs are damaged, they may lose their ability to retain the wheel. This could lead to the loss of the wheel and a collision resulting in serious injuries.
- Check the inflation pressures as soon as possible after installing the spare tire. Adjust it to the specified pressure, if necessary. Refer to "Tire Pressure Monitoring System (TPMS) (if equipped)" on page 7-9.

Important - use of compact spare tire

The compact spare tire is smaller than a conventional tire and is designed for temporary use only.

Precautions

- Do not exceed 80 km/h (50 mph).
- Drive slowly enough to avoid all hazards.
- Continuous road use could result in tire failure, loss of vehicle control, and possible personal injury.
- Do not exceed the vehicle's maximum load rating or the load carrying capacity.
- Avoid driving over obstacles.
- Do not take the vehicle through an automatic car wash.

- Do not use tire chains on the temporary compact tire.
- Do not install on the front axle if the vehicle must be driven in snow or on ice.
- Do not use on any other vehicle.
- Inspect your compact spare tire regularly and replace with the same size and design.
- The compact spare tire should not be used on any other wheels, nor should standard tires, snow tires, wheel covers or trim rings be used with the compact spare wheel.
- Do not use more than one compact spare tire at a time.
- Do not tow a trailer while the compact spare tire is installed.

WARNING

The compact spare tire is for emergency use only. Do not operate your vehicle on this compact spare at the speed over 80 km/h (50 mph). The original tire should be repaired or replaced as soon as possible to avoid failure of the spare possibly leading to personal injury or death.

CAUTION

- You should drive carefully when the compact spare is in use. The compact spare should be replaced by the proper conventional tire and rim at the first opportunity.
- The operation of this vehicle is not recommended with more than one compact spare tire in use at the same time.
- Check the inflation pressure after installing the spare tire. Adjust it to the specified pressure, as necessary.

Jack label

Type A

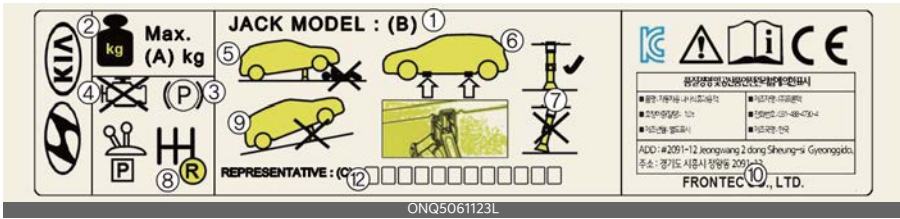

Type B

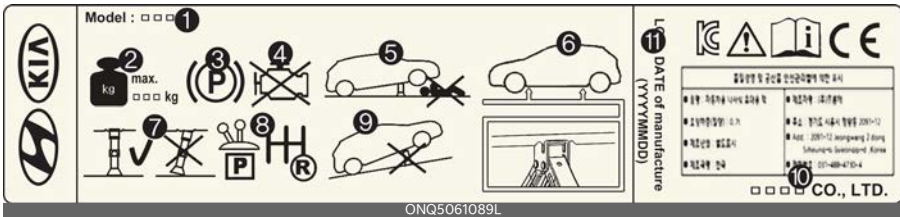

Type C



Type D

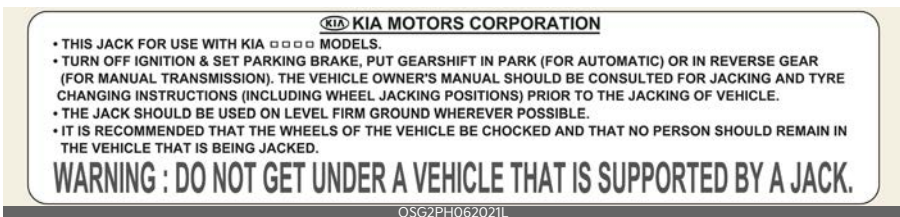

* The actual Jack label in the vehicle may differ from the illustration. For more detailed specifications, refer to the label attached to the jack.

- 1 Model Name
- 2 Maximum allowable load
- 3 When using the jack, set your parking brake.
- 4 When using the jack, stop the engine.

- 5 Do not get under a vehicle that is supported by a jack.
- 6 The designated locations under the frame
- 7 When supporting the vehicle, the base plate of jack must be vertical under the lifting point.
- 8 Move the shift position to the P (Park) position on vehicles.
- 9 The jack should be used on firm level ground.
- 10 Jack manufacturer
- 11 Production date
- 12 Representative company and address

EC Declaration of Conformity for Jack



The image shows a printed document titled "EC Declaration of Conformity according to EC Machinery Directive 2006/42/EC". At the top left is the CE mark. The document is issued by SAMKI IND. CO., LTD. located at # 176, Techno saneop-ro 29beon-gil, Nam-Gu, Ulsan, Korea 44776. It declares responsibility for the product: Jack Assembly. The brand name is Pantograph Type. The product designations include Jack Assembly-600kg, Jack Assembly-700kg, Jack Assembly-800kg, Jack Assembly-1000kg, and Jack Assembly-1200kg, Jack Assembly-1500kg. The serial number is N/A (prototype) and the year of manufacture is 2020. The document references standards EN ISO12100 (Safety of machinery - General principles for design - Risk assessment and risk reduction) and EN 1494/A1 (Mobile or movable jacks and associated lifting equipment). It states conformity with Directive 2006/42/EC. The document is dated 09.03.2020 and signed by Byong Suk Choi, President. A T.C.F. Compliance Location is listed in FRYDEK, MISTEK, CZECH REPUBLIC.

CE

EC Declaration of Conformity
according to EC Machinery Directive 2006/42/EC

We, **SAMKI IND. CO., LTD.**
176, Techno saneop-ro 29beon-gil, Nam-Gu, Ulsan, Korea 44776
declare under our sole responsibility that the product

Product : Jack Assembly
Brand Name : Pantograph Type
Type Designation(s) : Jack Assembly-600kg, Jack Assembly-700kg
Jack Assembly-800kg, Jack Assembly-1000kg
Jack Assembly-1200kg, Jack Assembly-1500kg
Serial No. : N/A (prototype)
Year fo Manufacture : 2020

to which this declaration relates is in conformity with the following standard(s) or other normative document(s);

EN ISO12100 Safety of machinery - General principles for design - Risk assessment and risk reduction (2010)
EN 1494/A1 Mobile or movable jacks and associated lifting equipment (2008)

following the provisions of Directive(s):
2006/42/EC Directive on the approximation of the laws of Member States relating to machinery (OJ L157 Jun, 9, 2006)

Ulsan , Korea / 09.03.2020 Byong Suk Choi President
(Place and date of issue)/(name and signature or equivalent making of authorized person)

* T.C.F. Compliance Location
- Address: FRIBORSKA 280, 739 42 FRYDEK MISTEK, CHLEBOVICE, CZECH REPUBLIC
- Team: Purchase team
- Company name: HANWHA

OSG2PH052140L

If you have a flat tire (with Tire Mobility Kit) (if equipped)



1 Sealant bottle

2 Compressor

* The Tire Mobility Kit is stored on the sides of the luggage room or below the luggage board.

The Tire Mobility Kit is not designed or intended as a permanent tire repair method and is to be used for one tire only.

The system with compressor and sealing compound seals most tire punctures caused by nails or similar objects and reinflates the tire. However, larger punctures or sidewall damage cannot be sealed completely.

After ensuring that the tire is properly sealed, you can drive cautiously on the tire (for a distance of up to 200 km (120 miles)) at maximum speed of 80 km/h (50 mph) in order to reach a service station or a tire dealer to have the tire replaced.

Avoid abrupt steering or other driving maneuvers if the vehicle is heavily loaded or if a trailer is in use.

Refer to "Notes on the safe use of the Tire Mobility Kit" on page 7-24.

⚠ WARNING

- Do not use the Tire Mobility Kit to repair punctures in the tire walls. This can result in an accident due to tire failure.
- Have your tire repaired as soon as possible. The tire may lose air pressure at any time after inflating with the Tire Mobility Kit.
- Do not use the TMK if a tire is severely damaged by driving run flat or with insufficient air pressure. Only punctured areas located within the tread region of the tire can be sealed using the TMK.
- Do not use the Tire sealant after the sealant has expired (i.e. past the expiration date on the sealant container). This can increase the risk of tire failure.
- Keep the sealant out of reach of children, avoid sealant contact with eyes and do not swallow the sealant.

⚠ CAUTION

When two or more tires are flat, do not use the tire mobility kit because the supported one sealant of Tire Mobility Kit is only used for one flat tire.

Components of the Tire Mobility Kit



* Connectors, cable and connection hose are stored in the compressor housing.

* Strictly follow the specified sequence, otherwise the sealant may escape under high pressure.

- 1 Speed restriction label
- 2 Sealant bottle
- 3 Sealant bottle filling hose
- 4 Power outlet connector
- 5 Sealant bottle holder
- 6 Compressor
- 7 ON/OFF switch
- 8 Tire inflation pressure gauge
- 9 Tire inflation pressure valve

Using the Tire Mobility Kit

Operation

1. Shake the sealant bottle.



OSG2H061014

2. Connect the filling hose onto the connector of the sealant bottle. (A)
Remove the sealant bottle cap and sealant bottle holder cap and connect the bottle onto the sealant bottle holder. (B)

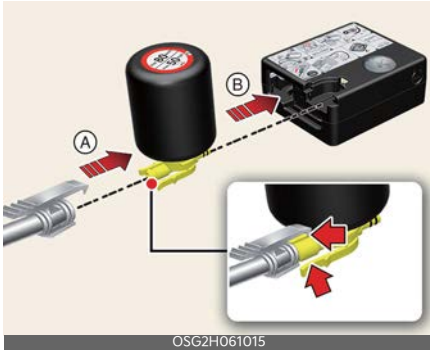

OSG2H061015

3. Make sure the compressor valve on the filling hose is locked.



OSG2PH062010L

4. Unscrew the valve cap and screw the filling hose onto the tire valve.



OSG2H061007

5. Make sure the compressor is turned off.
6. Connect the power outlet connector.



OSG2H041045

7. Start the vehicle.
8. Turn the compressor on and let it run for approximately 5~7 minutes to fill the sealant up to the proper pressure.
9. Turn the compressor off.
10. Detach the filling hose from the tire valve.

Distributing the sealant



OSG2H061008_2

Operation

- Immediately drive approximately 7~10 km (4~6 miles, or approximately 10 minutes) to distribute the tire sealant evenly.

⚠ WARNING

- Do not leave your vehicle running in a poorly ventilated area for extended periods of time. Carbon monoxide poisoning and suffocation can occur.
- If the tire pressure is below 26 psi(180 kPa), do not drive the vehicle. The tire may cause accident.

⚠ CAUTION

- Securely install the sealant filling hose to the valve. If not, sealant may flow backward, possibly clogging the filling hose.
- Do not exceed a speed of 80 km/h (50 mph). If possible, do not fall below a speed of 20 km/h (12 mph). While driving, if you experience any unusual vibration, ride disturbance or noise, reduce your speed and drive with caution until you can safely pull off of the side of the road. Call for road side service or towing. When you use the Tire Mobility Kit, the wheel may be stained by sealant. Therefore, remove the wheel stained by sealant and have the vehicle inspected at a professional workshop. Kia recommends visiting an authorized Kia dealer/service partner.

Checking tire inflation pressure

Operation

1. After driving approximately 7~10 km (4~6 miles, or approximately 10 minutes), stop the vehicle in a safe, level place.
2. Connect the filling hose directly to the tire valve.



3. Connect the power outlet connector.
4. Adjust the tire inflation pressure to the specified value.
 - Turn the compressor on to increase the inflation pressure. Turn the compressor off briefly to check the current inflation pressure.
 - Turn the compressor valve to reduce the inflation pressure.

⚠ WARNING

- Do not let the compressor run for more than 10 minutes, otherwise the device will overheat and may be damaged.
- The tire inflation pressure must be inflated to the proper pressure (Refer to "Tires and wheels" on page 9-5). If it is not, do not continue driving. Call for road side service or towing.

⚠ CAUTION

- If the inflation pressure is not maintained, drive the vehicle a second time, refer to "Distributing the sealant" on page 7-22. Then repeat steps 1 to 4.
- Use of the TMK may be ineffectual for tire damage larger than approximately 4 mm (0.16 inches).
- We recommend that you contact a professional workshop if the tire cannot be made roadworthy with the Tire Mobility Kit.

*** NOTICE**

When reinstalling the repaired or replaced tire and wheel on the vehicle, tighten the wheel lug nut to 11~13 kgf·m (79~94 lbf·ft).

Notes on the safe use of the Tire Mobility Kit

- Stop the vehicle in a safe, level place away from traffic.
- Set the parking brake.
- Only use the Tire Mobility Kit for sealing/inflating passenger vehicle tires.
- Do not remove any foreign objects from the tire.
- Read the precautionary advice printed on the sealant bottle before using the Tire Mobility Kit.
- Leave the vehicle running. Operating the Tire Mobility Kit may drain the battery.
- Never leave the Tire Mobility Kit unattended while it is being used.
- Do not leave the compressor running for more than approximately 10 minutes at a time or it may overheat.
- Do not use the Tire Mobility Kit if the ambient temperature is below -30 °C (-22 °F).
- Do not use the Tire Mobility Kit if the tire and wheel are damaged.

Technical Data

- System voltage: DC 12 V
- Working voltage: DC 12 V
- Amperage rating: max. 10 A ± 1 A
- Suitable temperatures: -30 to 70 °C (-22 to 158 °F)
- Max. working pressure: 6 bar (87 psi)
- Size
 - Compressor: 118 x 130 x 52 mm (4.6 x 5.1 x 2.0 inches)
 - Sealant bottle: 121 x 76 ø mm (4.8 x 3.0 ø inches)
 - Compressor weight: 470 ± 30g (1.04 ± 0.07 lbs.)
 - Sealant volume: 300 ml (18.3 cu. in)

* Sealant and spare parts can be obtained and replaced at an authorized vehicle or tire dealer. Empty sealant bottles may be disposed of at home. Liquid residue from the sealant should be disposed of by your vehicle or tire dealer or in accordance with local waste disposal regulations.

Towing

Towing service

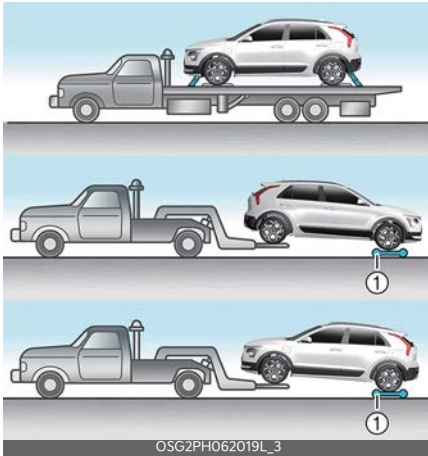

OSG2PH062019L_3

1 Wheel dolly

- Proper lifting and towing procedures are necessary to prevent damage to the vehicle. The use of wheel dolly (1) or flatbed is recommended.
- On 2WD vehicles, it is acceptable to tow the vehicle with the rear wheels on the ground (without dollies) and the front wheels off the ground.

* INFORMATION

If emergency towing is necessary, we recommend having it done by an authorized Kia dealer or a commercial tow-truck service.



OSG2PH062011L

When being towed by a commercial tow truck and wheel dollies are not used, the front of the vehicle should always be lifted, not the rear

Towing without wheel dolly

Operation

1. Set the vehicle to ACC (Accessory).
2. Change the gear to N (Neutral).
3. Release the parking brake.

⚠ CAUTION

Failure to shift the gear to N (Neutral) may cause internal damage to the transmission.

Emergency towing

Front



OSG2H061012

Rear



OSG2H061013

Operation

1. Remove the hole cover pressing the lower part of the cover on the bumper.
2. Install the towing hook by turning it clockwise into the hole until it is fully secured.
3. Remove the towing hook and install the cover after use.

* INFORMATION

Towing in this manner may be done only on hard-surfaced roads for a short distance and at low speed. Also, the wheels, axles, power train, steering and brakes must all be in good condition.

- If towing is necessary, we recommend you to have it done by an authorized Kia dealer or a commercial tow truck service. If towing service is not available in an emergency, your vehicle may be temporarily towed using a cable or chain secured to the emergency towing hook under the front (or rear) of the vehicle. Use extreme caution when towing the vehicle. A driver must be in the vehicle to steer it and operate the brakes.
- Do not use the tow hooks to pull a vehicle out of mud, sand or other conditions from which the vehicle cannot be driven out under its own power.
- Avoid towing a vehicle heavier than the vehicle doing the towing.
- The drivers of both vehicles should communicate with each other frequently.
- Before emergency towing, check if the hook is not broken or damaged.
- Fasten the towing cable or chain securely to the hook.
- Do not jerk the hook. Apply it steadily and with even force.

- To avoid damaging the hook, do not pull from the side or at a vertical angle. Always pull straight ahead.
- Change the gear to N (Neutral).
- Release the parking brake.
- To avoid serious damage to the dual clutch transmission, limit the vehicle speed to 15 km/h (10 mph) and drive less than 1.5 km (1 mile) when towing. (for dual clutch transmission)
- Press the brake pedal with more force than normal since you will have reduced brake performance.
- More steering effort will be required because the power steering system will be disabled.
- If you are driving down a long hill, the brakes may overheat and brake performance will be reduced. Stop often and let the brakes cool off.
- The driver must be in the vehicle for steering and braking operations when the vehicle is towed and passengers other than the driver must not be allowed to be on board.

⚠ WARNING

Use extreme caution when towing the vehicle.

- Avoid sudden starts or erratic driving maneuvers which would place excessive stress on the emergency towing hook and towing cable or chain. The hook and towing cable or chain may break and cause serious injury or damage.
- If the disabled vehicle is unable to be moved, do not forcibly continue the towing. We recommend that you contact an authorized Kia dealer or a commercial tow truck service for assistance.

- Tow the vehicle as straight ahead as possible.
- Keep away from the vehicle during towing.

CAUTION

- Attach a towing strap to the tow hook.
- Using a portion of the vehicle other than the tow hooks for towing may damage the body of your vehicle.
- Use only a cable or chain specifically intended for use in towing vehicles. Securely fasten the cable or chain to the towing hook provided.
- Accelerate or decelerate the vehicle in a slow and gradual manner while maintaining tension on the tow rope or chain to start or drive the vehicle, otherwise tow hooks and the vehicle may be damaged.
- If the car is being towed with all four wheels on the ground, it can be towed only from the front. Be sure that the transmission is in N (Neutral). A driver must be in the towed vehicle to operate the steering and brakes.
- Before towing, check the dual clutch transmission for fluid leaks under your vehicle. If the dual clutch transmission fluid is leaking, flatbed equipment or a towing dolly must be used.

Emergency commodity (if equipped)

There are some emergency commodities in the vehicle to help you respond to the emergency situation.

Fire extinguisher

1. Pull the pin at the top of the extinguisher.
2. Aim the nozzle toward the base of the fire.
3. Stand approximately 2.5 m (8 ft) away from the fire and squeeze the handle to discharge the extinguisher. If you release the handle, the discharge will stop.
4. Sweep the nozzle back and forth at the base of the fire. After the fire appears to be out, watch it carefully since it may re-ignite.

First aid kit

Scissors, bandage and adhesive tape and etc. in the kit is provided.

Triangle reflector

Place the triangle reflector on the road to warn oncoming vehicles.

Tire pressure gauge

To check the tire pressure, take the following steps:

1. Unscrew the inflation valve cap.
2. Press and hold the gauge against the tire valve.
3. A firm non-leaking push will activate the gauge.
 - Read the tire pressure on the gauge to know whether the tire pressure is low or high.

- 4. Adjust the tire pressures to the specified pressure.
- 5. Reinstall the inflation valve cap.

Pan-European eCall system (if equipped)

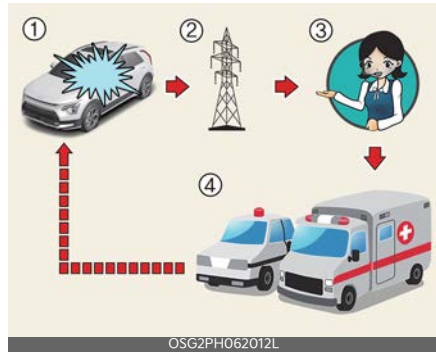

- 1 Road accident
- 2 Wireless network
- 3 Public Safety Answering Point (PSAP)
- 4 Rescue

The car is equipped with a device¹ connected with the Pan-European eCall system for making emergency call to response teams. The Pan-European eCall system is an automatic emergency call service made in event of a traffic accident or other² accidents on the roads of Europe. (only in countries with regulation on this system)

The system allows contacting with an officer of the single duty dispatch service in case of accidents on the roads of Europe. (only in countries with regulation on this system)

The Pan-European eCall system given conditions, stated in the Owner's Manual as well as Warranty and Service book transmits data to the Public Safety Answering Point (PSAP) including such information as vehicle location, vehicle type, VIN (vehicle identification number of the car).

Once the data which is stored in the Pan-European eCall system is delivered

to the rescue center to assist the driver and passengers with proper rescue operations, the data will be deleted after rescue operation is completed.

*1. Pan-European eCall device in the Owner's Manual means equipment, installed in the car, which provides connection with the Pan-European eCall system.

*2. "Other accidents" mean any accidents on the roads of Europe (only in countries with regulation on this system) resulted in injured people and/or necessity of provision of assistance. In case of registration of any accident, it is necessary to stop a vehicle, press button SOS (location of the button is specified on the picture in the chapter "Pan-European eCall (IF EQUIPPED)") of the Owner's Manual. When making a call, the system gathers information about the car (from which a call was made), after which connects the car with an officer of the Public Safety Answering Point (PSAP) to tell about the reason of the emergency call.

Description of the ecall in-vehicle system

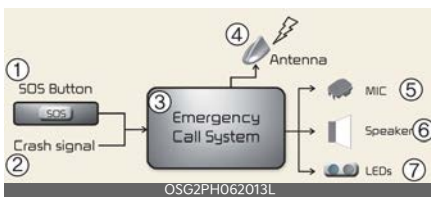

- 1 SOS Button
- 2 Crash signal
- 3 Emergency Call System
- 4 Antenna
- 5 MIC
- 6 Speaker
- 7 LEDs

Overview of the 112-based eCall in-vehicle system, its operation and functionalities: refer to this section. The 112-based eCall service is a public service of general interest and is accessible free of charge.

The 112-based eCall in-vehicle system is activated by default. It is activated automatically by means of in- vehicle sensors in the event of a severe accident.

It will also be triggered automatically when the vehicle is equipped with a TPS system which does not function in the event of a severe accident.

The 112-based eCall in-vehicle system can also be triggered manually, if needed. Instructions for manual activation of the system: refer to this section. In the event of a critical system failure that would disable the 112-based eCall in-vehicle system, the following warning will be given to the occupants of the vehicle: refer to this section.

Information on data processing

Any processing of personal data through the 112-based eCall in-vehicle system shall comply with the personal data protection rules provided for in Directives 95/46/EC (1) and 2002/58/EC (2) of the European Parliament and of the Council, and in particular, shall be based on the necessity to protect the vital interests of the individuals in accordance with Article 7(d) of Directive 95/46/EC (3).

Processing of such data is strictly limited to the purpose of handling the emergency eCall to the single European emergency number 112.

Types of data and its recipients

The 112-based eCall in-vehicle system may collect and process only the following data:

- Vehicle Identification Number
- Vehicle type (passenger vehicle or light commercial vehicle)
- Vehicle propulsion storage type (gasoline/diesel/CNG/LPG/electric/hydrogen)
- Vehicle recent locations and direction of travel
- Log file of the automatic activation of the system and its timestamp
- Any additional data (if applicable): Not applicable

Recipients of data processed by the 112-based eCall in-vehicle system are the relevant public safety answering points designated by the respective public authorities of the country on which territory they are located, to first receive and handle eCalls to the single European emergency number 112. Additional information (if available): Not applicable

1. Directive 95/46/EC of the European Parliament and of the Council of 24 October 1995 on the protection of individuals with regard to the processing of personal data and on the free movement of such data (OJ L 281, 23.11.1995, p. 31).
2. Directive 2002/58/EC of the European Parliament and of the Council of 12 July 2002 concerning the processing of personal data and the protection of privacy in the electronic communications sector (Directive on privacy and electronic communications) (OJ L 201, 31.7.2002, p. 37).
3. Directive 95/46/EC is repealed by Regulation (EU) 2016/679 of the Euro-

pean Parliament and of the Council of 27 April 2016 on the protection of natural persons with regard to the processing of personal data and on the free movement of such data (General Data Protection Regulation) (OJ L 119, 4.5.2016, p. 1). The Regulation applies from 25 May 2018.

Arrangements for data processing

The 112-based eCall in-vehicle system is designed in such a way as to ensure that the data contained in the system memory is not available outside the system before an eCall is triggered. Additional remarks (if any): Not applicable

The 112-based eCall in-vehicle system is designed in such a way as to ensure that it is not traceable and not subject to any constant tracking in its normal operation status. Additional remarks (if any): Not applicable

The 112-based eCall in-vehicle system is designed in such a way as to ensure that data in the system internal memory is automatically and continuously removed.

The vehicle location data is constantly overwritten in the internal memory of the system so as always to keep maximum of the last three up-to-date locations of the vehicle necessary for the normal functioning of the system.

The log of activity data in the 112-based eCall in-vehicle system is kept for no longer than necessary for attaining the purpose of handling the emergency eCall and in any case not beyond 13 hours from the moment an emergency eCall was initiated. Additional remarks (if any): Not applicable

Modalities for exercising data subject's rights

The data subject (the vehicle's owner) has a right of access to data and as appropriate to request the rectification, erasure or blocking of data, concerning him or her, the processing of which does not comply with the provisions of Directive 95/46/EC. Any third parties to whom the data have been disclosed have to be notified of such rectification, erasure or blocking carried out in compliance with this Directive, unless it proves impossible or involves a disproportionate effort.

The data subject has a right to complain to the competent data protection authority if he or she considers that his or her rights have been infringed as a result of the processing of his or her personal data.

Contact service responsible for handling access requests (if any): Not applicable

Pan-European eCall System



Elements of the Pan-European eCall system, installed in passenger compartment:

- 1 Microphone
- 2 SOS button
- 3 LED

SOS button: the driver/passenger makes an emergency call to the single duty dispatch service by pressing the button.

LED: The red and green LED illuminates for 3 seconds when the ignition switch is in the ON position. After that they will switch off at normal operation of the system.

If there are some problems in the system, the LED remains in red.

Automatic accident reporting

1. System operation in the event of a traffic accident



2. Connection with the Public Safety Answering Point (PSAP)



3. Emergency services



The Pan-European eCall device automatically makes an emergency call to the Public Safety Answering Point (PSAP) for proper rescuing operations in event of car accident.

For proper emergency services and support the Pan-European eCall system automatically transmits the accident data to the Public Safety Answering Point (PSAP) when a traffic accident is detected.

In this case, the emergency call cannot be hung up by pressing the SOS button and the Pan-European eCall system remains connected until the emergency service officer, receiving the call, disconnects the emergency call.

In minor traffic accidents the Pan-European eCall system may not execute an emergency call. However, an emergency call may be made manually by pressing the SOS button.

CAUTION

Operation of the system is impossible in case of absence of mobile transmission and GPS and Galileo signals.

Manual accident reporting



The driver or passenger manually can make an emergency call in the Public Safety Answering Point (PSAP), by pressing SOS button to call the necessary emergency services.

A call to the emergency services through the Pan-European eCall system can be canceled by pressing the SOS button again only before the call connection.

After activation of emergency call in the manual mode (for proper emergency services and support), the Pan-European eCall system automatically transmits the road accident data / or data on other accident to the officer of the Public Safety Answering Point (PSAP) (during emergency call) by pressing the SOS button.

If the driver or passenger accidentally presses the SOS button, it can be canceled by pressing the button again in 3 seconds. It can't be canceled after that.

In case of road accident or other accident for activation of emergency call in manual mode it is necessary:

1. Stop the car in accordance with traffic rules to ensure safety to yourself and other participants of road traffic;
2. Press the SOS button, when pressing the button SOS registration of the device in the wireless telephonic communication networks is carried out, minimum data set about car and its location is collected in accordance with of the technical requirements of the device.

After that connection with the officer of the Pan-European eCall system is made for clearing up reasons (conditions) of the emergency call.

3. After clearing up reasons of the emergency call, the officer of the Public Safety Answering Point (PSAP) sends emergency services and completes the emergency call.

If the emergency call is not carried out in accordance with the procedure, mentioned above, the emergency call will be considered as erroneous.

⚠ WARNING

Emergency power supply of the Pan-European eCall system from the battery

- The Pan-European eCall system battery supplies power during 1 hour in case main power source of the vehicle is cut off due to the collision during the emergency situations.
- The Pan-European eCall system battery should be replaced every 4 years.

LED illumination in red (system malfunction)

If red LED illuminates in normal driving conditions, this can indicate malfunction of the Pan-European eCall system. Please, have the Pan-European eCall system checked at an authorized Kia dealership immediately. Otherwise correct operation of the Pan-European eCall system device, installed in your car is not guaranteed. Owner of the car incurs liability for consequences, occurred as a result of nonobservance of conditions, mentioned above.

Arbitrary Removal or Modification

The Pan-European eCall system calls emergency services for assistance. Thus, any arbitrary removal or changes to the Pan-European eCall system settings may affect your driving safety. Also, it may even make an erroneous emergency call to the Public Safety Answering Point (PSAP). Thereby, we kindly ask you not to make any changes by yourself or by the third parties in the settings of the equipment of the Pan-European eCall system, installed in your car.

UAE eCall system (if equipped)

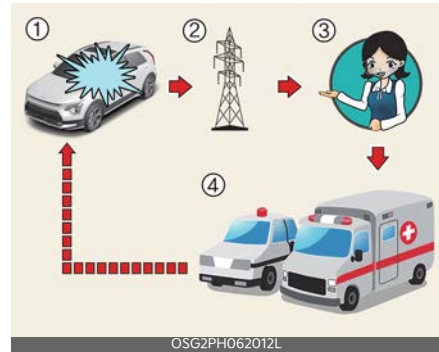

- 1 Road accident
- 2 Wireless network
- 3 Public Safety Answering Point (PSAP)
- 4 Rescue

The vehicle is equipped with a device¹ connected with the UAE eCall system for making emergency call to response teams. The UAE eCall system is an automatic emergency call service made in event of a traffic accident or other² accidents on the roads of Middle East. (only in countries with regulation on this system)

The system allows contacting with an officer of the single duty dispatch service in case of accidents on the roads of Middle East. (only in countries with regulation on this system)

The UAE eCall system given conditions, stated in the Owner's Manual as well as Warranty and Service book transmits data to the Public Safety Answering Point (PSAP) including such information as vehicle location, vehicle type, VIN (vehicle identification number of the vehicle).

Once the data which is stored in the UAE eCall system is delivered to the rescue center to assist the driver and passengers with proper rescue operations, the data will be deleted after rescue operation is completed.

*1. UAE eCall device in the Owner's Manual means equipment, installed in the vehicle, which provides connection with the UAE eCall system.

*2. "Other accidents" mean any accidents on the roads of Middle East (only in countries with regulation on this system) resulted in injured people and/or necessity of provision of assistance. In case of registration of any accident, it is necessary to stop a vehicle, press button SOS (location of the button is specified on the picture in "UAE eCall System" on page 7-36. When making a call, the system gathers information about the vehicle (from which a call was made), after which connects the vehicle with an officer of the Public Safety Answering Point (PSAP) to tell about the reason of the emergency call.

Description of the eCall in-vehicle system

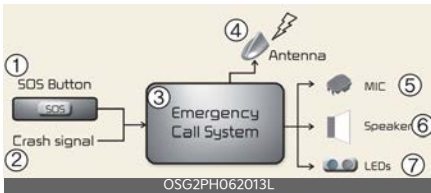

- 1 SOS Button
- 2 Crash signal
- 3 Emergency Call System
- 4 Antenna
- 5 MIC
- 6 Speaker
- 7 LEDs

Overview of the 999-based eCall in-vehicle system, its operation and functionalities: refer to this section. The 999-based eCall service is a public service of general interest and is accessible free of charge.

The 999-based eCall in-vehicle system is activated by default. It is activated automatically by means of in- vehicle sensors in the event of a severe accident.

It will also be triggered automatically when the vehicle is equipped with a TPS system which does not function in the event of a severe accident.

The 999-based eCall in-vehicle system can also be triggered manually, if needed. Instructions for manual activation of the system: refer to this section.

In the event of a critical system failure that would disable the 999-based eCall in-vehicle system, the following warning will be given to the occupants of the vehicle: refer to this section.

Information on data processing

Any processing of personal data through the 999-based eCall in-vehicle system shall comply with the personal data protection rules provided for in Directives 95/46/EC (1) and 2002/58/EC (2) of the European Parliament and of the Council, and in particular, shall be based on the necessity to protect the vital interests of the individuals in accordance with Article 7(d) of Directive 95/46/EC (3).

Processing of such data is strictly limited to the purpose of handling the emergency eCall to the single emergency number 999.

Types of data and its recipients

The 999-based eCall in-vehicle system may collect and process only the following data:

- Vehicle Identification Number
- Vehicle type (passenger vehicle or light commercial vehicle)
- Vehicle propulsion storage type (gasoline/diesel/CNG/LPG/electric/hydrogen)
- Vehicle recent locations and direction of travel
- Log file of the automatic activation of the system and its timestamp
- Any additional data (if applicable): Not applicable

Recipients of data processed by the 999-based eCall in-vehicle system are the relevant public safety answering points designated by the respective public authorities of the country on which territory they are located, to first receive and handle eCalls to the single emergency number 999. Additional information (if available): Not applicable

1. Directive 95/46/EC of the European Parliament and of the Council of 24 October 1995 on the protection of individuals with regard to the processing of personal data and on the free movement of such data (OJ L 281, 23.11.1995, p. 31).
2. Directive 2002/58/EC of the European Parliament and of the Council of 12 July 2002 concerning the processing of personal data and the protection of privacy in the electronic communications sector (Directive on privacy and electronic communications) (OJ L 201, 31.7.2002, p. 37).
3. Directive 95/46/EC is repealed by Regulation (EU) 2016/679 of the Euro-

pean Parliament and of the Council of 27 April 2016 on the protection of natural persons with regard to the processing of personal data and on the free movement of such data (General Data Protection Regulation) (OJ L 119, 4.5.2016, p. 1). The Regulation applies from 25 May 2018.

Arrangements for data processing

The 999-based eCall in-vehicle system is designed in such a way as to ensure that the data contained in the system memory is not available outside the system before an eCall is triggered. Additional remarks (if any): Not applicable

The 999-based eCall in-vehicle system is designed in such a way as to ensure that it is not traceable and not subject to any constant tracking in its normal operation status. Additional remarks (if any): Not applicable

The 999-based eCall in-vehicle system is designed in such a way as to ensure that data in the system internal memory is automatically and continuously removed.

The vehicle location data is constantly overwritten in the internal memory of the system so as always to keep maximum of the last three up-to-date locations of the vehicle necessary for the normal functioning of the system.

The log of activity data in the 999-based eCall in-vehicle system is kept for no longer than necessary for attaining the purpose of handling the emergency eCall and in any case not beyond 13 hours from the moment an emergency eCall was initiated. Additional remarks (if any): Not applicable

Modalities for exercising data subject's rights

The data subject (the vehicle's owner) has a right of access to data and as appropriate to request the rectification, erasure or blocking of data, concerning him or her, the processing of which does not comply with the provisions of Directive 95/46/EC. Any third parties to whom the data have been disclosed have to be notified of such rectification, erasure or blocking carried out in compliance with this Directive, unless it proves impossible or involves a disproportionate effort.

The data subject has a right to complain to the competent data protection authority if he or she considers that his or her rights have been infringed as a result of the processing of his or her personal data.

Contact service responsible for handling access requests (if any): Not applicable

UAE eCall System



Elements of the UAE eCall system, installed in passenger compartment:

- 1 Microphone
- 2 SOS button
- 3 LED

SOS button: the driver/passenger makes an emergency call to the single duty dispatch service by pressing the button.

LED: The green LED appears for 3 seconds when the ENGINE START/STOP button is in the ON position. After that they will switch off at normal operation of the system.

Automatic accident reporting

1. System operation in the event of a traffic accident



2. Connection with the Public Safety Answering Point (PSAP)



3. Emergency services



The UAE eCall device automatically makes an emergency call to the Public Safety Answering Point (PSAP) for proper rescuing operations in event of vehicle accident.

For proper emergency services and support the UAE eCall system automatically transmits the accident data to the Public Safety Answering Point (PSAP) when a traffic accident is detected.

In this case, the emergency call cannot be hung up by pressing the SOS button and the UAE eCall system remains con-

nected until the emergency service officer, receiving the call, disconnects the emergency call.

In minor traffic accidents the UAE eCall system may not execute an emergency call. However, an emergency call may be made manually by pressing the SOS button.

CAUTION

Operation of the system is impossible in case of absence of mobile transmission and GPS and Galileo signals.

Manual accident reporting



The driver or passenger manually can make an emergency call in the Public Safety Answering Point (PSAP), by pressing SOS button to call the necessary emergency services.

A call to the emergency services through the UAE eCall system can be canceled by pressing the SOS button again only before the call connection.

After activation of emergency call in the manual mode (for proper emergency services and support), the UAE eCall sys-

tem automatically transmits the road accident data/or data on other accident to the officer of the Public Safety Answering Point (PSAP) (during emergency call) by pressing the SOS button. If the driver or passenger accidentally presses the SOS button, it can be canceled by pressing the button again in 3 seconds. It can't be canceled after that.

In case of road accident or other accident for activation of emergency call in manual mode it is necessary:

1. Stop the vehicle in accordance with traffic rules to ensure safety to yourself and other participants of road traffic;
2. Press the SOS button, when pressing the button SOS registration of the device in the wireless telephonic communication networks is carried out, minimum data set about vehicle and its location is collected in accordance with of the technical requirements of the device.

After that connection with the officer of the UAE eCall system is made for clearing up reasons (conditions) of the emergency call.

3. After clearing up reasons of the emergency call, the officer of the Public Safety Answering Point (PSAP) sends emergency services and completes the emergency call.

If the emergency call is not carried out in accordance with the procedure, mentioned above, the emergency call will be considered as erroneous.

⚠ WARNING

Emergency power supply of the UAE eCall system from the battery

- The UAE eCall system battery supplies power during 1 hour in case main power source of the vehicle is cut off due to the collision during the emergency situations.
 - The UAE eCall system battery should be replaced every 4 years. For more information refer to "Scheduled maintenance service" on page 8-9.
-

LED illumination in red (system malfunction)

If red LED illuminates in normal driving conditions, this can indicate malfunction of the UAE eCall system. Please, have the UAE eCall system checked at an authorized Kia dealer/service partner. Otherwise correct operation of the UAE eCall system device, installed in your vehicle is not guaranteed. Owner of the vehicle incurs liability for consequences, occurred as a result of nonobservance of conditions, mentioned above.

Arbitrary removal or modification

The UAE eCall system calls emergency services for assistance. Thus, any arbitrary removal or changes to the UAE eCall system settings may affect your driving safety. Also, it may even make an erroneous emergency call to the Public Safety Answering Point (PSAP). Thereby, we kindly ask you not to make any changes by yourself or by the third parties in the settings of the equipment of the UAE eCall system, installed in your vehicle.

Engine compartment	8-4
Maintenance services	8-6
• Owner's responsibility.....	8-6
• Owner maintenance precautions.....	8-6
Owner maintenance	8-7
• Owner maintenance schedule.....	8-7
Scheduled maintenance service	8-9
Explanation of scheduled maintenance items	8-20
• Engine oil and filter.....	8-20
• Hybrid Starter & Generator (HSG) belt.....	8-20
• Fuel filter.....	8-20
• Fuel lines, fuel hoses and connections.....	8-20
• Vapor hose and fuel filler cap.....	8-20
• Air cleaner filter.....	8-20
• Spark plugs.....	8-20
• Cooling system.....	8-21
• Coolant/inverter coolant.....	8-21
• Dual clutch transmission (DCT) fluid.....	8-21
• Brake hoses and lines.....	8-21
• Brake fluid.....	8-21
• Brake discs, pads and calipers.....	8-21
• Suspension mounting bolts.....	8-21
• Steering gear box, linkage & boots/lower arm ball joint.....	8-21
• Drive shafts and boots.....	8-21
• Air conditioning refrigerant.....	8-21
• Checking fluid levels.....	8-21
Engine oil	8-22
• Checking engine oil level.....	8-22
• Replenishing engine oil.....	8-22
• Changing engine oil and filter.....	8-22
Engine coolant	8-24

8 Maintenance

• Checking coolant level.....	8-24
• Checking the inverter coolant level (HEV).....	8-25
• Checking the inverter coolant level (PHEV).....	8-26
• Changing coolant.....	8-27
Hybrid starter & generator (HSG) belt	8-27
• Checking the Hybrid Starter & Generator (HSG) belt.....	8-27
Brake fluid	8-28
• Checking brake fluid level.....	8-28
Engine clutch actuator fluid	8-29
• Checking the engine clutch actuator fluid level.....	8-29
Washer fluid	8-30
• Checking washer fluid level	8-30
Air cleaner filter	8-30
• Replacing air cleaner filter	8-30
Climate control air filter	8-31
• Replacing climate control air filter	8-31
Wiper blades.....	8-32
• Replacing front wiper blade.....	8-32
• Replacing rear wiper blade.....	8-33
Battery (Plug-in hybrid).....	8-34
• For best battery service	8-34
• Battery capacity label	8-35
• Battery recharging	8-36
• Reset items	8-36
Tires and wheels	8-37
• Tire care	8-37
• Recommended cold tire inflation pressures	8-37
• Checking tire inflation pressure	8-37
• Tire rotation.....	8-38
• Wheel alignment and tire balance	8-39

• Tire replacement	8-39
• Wheel replacement	8-40
• Tire traction	8-40
• Tire maintenance	8-40
• Tire sidewall labeling	8-40
• Low aspect ratio tire	8-43
Fuses	8-44
• Replacing inner panel fuse	8-45
• Replacing engine compartment fuse	8-46
• Fuse/relay panel description	8-47
Light bulbs	8-57
• Bulb replacement precautions	8-57
• Light position (Front)	8-58
• Light position (Rear)	8-59
• Light position (Side)	8-59
• Replacing lights (LED type)	8-59
• Replacing headlamp (Low beam/High beam) (Bulb type)	8-60
• Replacing front turn signal lamp (Bulb type)	8-60
• Replacing rear turn signal lamp, backup lamp (Bulb type)	8-61
• Replacing side repeater lamp (Bulb type)	8-61
• Replacing license plate lamp (Bulb type)	8-62
• Replacing map lamp (Bulb type)	8-62
• Replacing room lamp (Bulb type)	8-62
• Replacing vanity mirror lamp (Bulb type)	8-63
• Replacing glove box lamp (Bulb type)	8-63
• Replacing luggage lamp (Bulb type)	8-63
• Headlamp and front fog lamp aiming (for Europe)	8-64
Appearance care	8-70
• Exterior care	8-70
• Interior care	8-74
Emission control system	8-76
• Procedure for entering forced engine activation mode	8-79

Maintenance

Engine compartment

Smartstream G1.6 GD*i* HEV

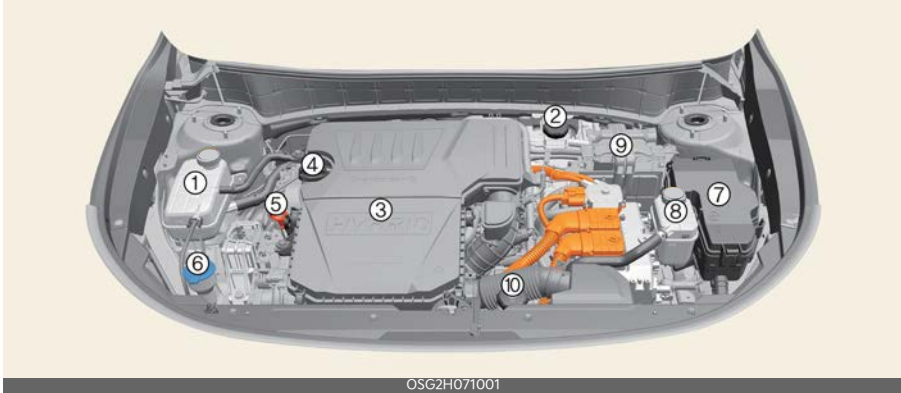

Smartstream G1.6 GD*i* PHEV

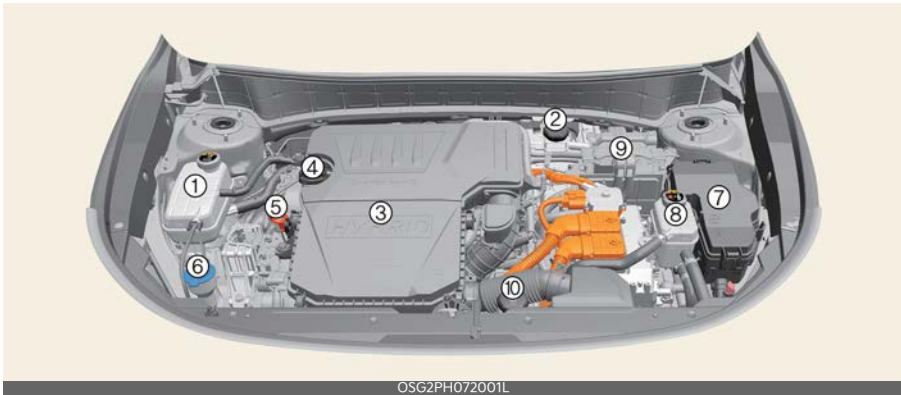

* The actual engine room in the vehicle may differ from the illustration.

- | | |
|--------------------------------------|------------|
| 1. Engine coolant reservoir | 8-24 |
| 2. Brake fluid reservoir | 8-28 |
| 3. Air cleaner | 8-30 |
| 4. Engine oil filler cap | 8-22 |
| 5. Engine oil dipstick | 8-22 |
| 6. Windshield washer fluid reservoir | 8-30 |
| 7. Fuse box | 8-46 |
| 8. Inverter coolant reservoir | 8-25, 8-26 |

9. Electric Control Unit (ECU)

7-5

10.Engine actuator reservoir tank

8-29

Maintenance services

Owner's responsibility

- Have your vehicle serviced by a professional workshop. Kia recommends to visit an authorized Kia dealer/service partner.
- Retain documents that show proper maintenance.
- Establish your compliance with the servicing and maintenance requirements of your vehicle warranties.
- Repairs and adjustments required as a result of improper maintenance or a lack of required maintenance are not covered when your vehicle is covered by warranty.

* NOTICE

Maintenance Service and Record Retention are the owner's responsibility.

Owner maintenance precautions

Improper or incomplete service may result in problems. This section gives instructions only for the maintenance items that are easy to perform.

⚠ WARNING

- Performing maintenance work on a vehicle can be dangerous. You can be seriously injured while performing some maintenance procedures. If you lack sufficient knowledge and experience or the proper tools and equipment to do the work, have the system serviced by a professional workshop. Kia recommends to visit an authorized Kia dealer/service partner.
- Working under the hood with the engine running is dangerous. It becomes even more dangerous when you wear jewelry or loose clothing. These can become entangled in mov-

ing parts and result in injury. Therefore, if you must run the engine while working under the hood, make certain that you remove all jewelry (especially rings, bracelets, watches, and necklaces) and all neckties, scarves, and similar loose clothing before getting near the engine or cooling fans.

⚠ CAUTION

- Do not put heavy objects or apply excessive force on top of the engine cover (if equipped) or fuel related parts.
- When you inspect the fuel system (fuel lines and fuel injection devices), contact a professional workshop. Kia recommends to visit an authorized Kia dealer/service partner.
- Do not drive long time with the engine cover removed.
- When checking the engine room, do not go near fire. Fuel, washer fluid, etc. are flammable oils that may cause fire.
- Before touching the battery, ignition cables and electrical wiring, you should disconnect the battery "-" terminal. You may get an electric shock from the electric current.
- When you remove the interior trim cover with a flat bed (-) driver, be careful not to damage the cover.
- Be careful when you replace and clean bulbs to avoid burns or electrical shock.

*** NOTICE**

Improper owner maintenance during the warranty period may affect warranty coverage. For details, read the separate Warranty & Maintenance book provided with the vehicle. If you're unsure about any servicing or maintenance procedure, have the system serviced by a professional workshop. Kia recommends to visit an authorized Kia dealer/service partner.

Owner maintenance**Owner maintenance schedule****When you stop for fuel**

- Check the coolant level in the coolant reservoir.
- Check the windshield washer fluid level.
- Look for low or under-inflated tires.

⚠ WARNING

Be careful when checking your engine coolant level when the engine is hot. Scalding hot coolant and steam may blow out under pressure. This could cause burns or other serious injury.

While operating your vehicle

- Note any changes in the sound of the exhaust or any smell of exhaust fumes in the vehicle.
- Check for vibrations in the steering wheel. Notice any increased steering effort or looseness in the steering wheel, or change in its straightahead position.
- Notice if your vehicle constantly turns slightly or "pulls" to one side when traveling on smooth, level road.
- When stopping, listen and check for unusual sounds, pulling to one side, increased brake pedal travel or "hard-to-push" brake pedal.
- If any slipping or changes in the operation of your transmission occurs, check the transmission fluid level.
- Check the parking brake.
- Check for fluid leaks under your vehicle (water dripping from the air conditioning system during or after use is normal).

At least monthly

- Check the coolant level in the engine coolant reservoir.
- Check the operation of all exterior lights, including the stoplights, turn signals and hazard warning flashers.
- Check the inflation pressures of all tires including the spare for tires that are worn, show uneven wear, or are damaged.
- Check for loose wheel lug nuts.

At least twice a year

- Check the radiator, heater and air conditioning hoses for leaks or damage.
- Check the windshield washer spray and wiper operation. Clean the wiper blades with clean cloth dampened with washer fluid.
- Check the headlight alignment.
- Check the muffler, exhaust pipes, shields and clamps.
- Check the lap/shoulder belts for wear and function.

At least once a year

- Clean the body and door drain holes.
- Lubricate the door hinges and checks, and hood hinges.
- Lubricate the door and hood locks and latches.
- Lubricate the door rubber weatherstrips.
- Check the air conditioning system.
- Inspect and lubricate the dual clutch transmission linkage and controls.
- Clean the battery and terminals.
- Check the brake fluid level.

Scheduled maintenance service

If your vehicle is operated in any of the severe driving conditions, you should inspect, replace or refill more frequently, using the severe usage maintenance schedule instead of the normal usage maintenance schedule.

Normal maintenance schedule - for Europe

The following maintenance services must be performed to ensure good emission control and performance. Keep receipts for all vehicle emission services to protect your warranty. Where both mileage and time are shown, the frequency of service is determined by whichever occurs first.

NO.	Item	Remark
*1	Engine oil and engine oil filter	<ul style="list-style-type: none"> As it is normal for engine oil to be consumed during driving, the engine oil level should be checked on regular basis. The engine oil change interval for normal operating conditions is based on the use of the recommended engine specification. If the recommended engine oil specification is not used, then replace the engine oil according to the maintenance schedule under severe operating conditions.
*2	Coolant (Engine)	When adding coolant, use only deionized water or soft water for your vehicle and never mix hard water in the coolant filled at the factory. An improper coolant mixture can result in serious malfunction or engine damage.
*3	Coolant (HEV Inverter)	When adding coolant, use only deionized water or soft water for your vehicle and never mix hard water in the coolant filled at the factory. An improper coolant mixture can result in serious malfunction or engine damage.
*4	Coolant (PHEV Inverter)	Recommend that the coolant be replaced by an authorized Kia dealer/service partner.
*5	HSG (Hybrid Starter & Generator) belt	Inspect HSG belt for evidence of cuts, cracks, excessive wear or oil saturation and replace if necessary.
*6	Spark plug	For your convenience, it can be replaced prior to it's interval when you do maintenance of other items.
*7	Dual clutch transmission (DCT) fluid	Dual clutch transmission (DCT) fluid should be changed anytime it has been submerged in water.
*8	Fuel additives	<p>Kia recommends that you use unleaded gasoline which has an octane rating of RON (Research Octane Number) 95/AKI (Anti Knock Index) 91 or higher.</p> <p>For customers who do not use good quality gasolines including fuel additives regularly, and have problems starting or the engine does not run smoothly, one bottle of additives should be added to the fuel tank when the engine oil is replaced. Additives are available from a professional workshop along with information on how to use them. Kia recommends to visit an authorized Kia dealer/service partner. Do not mix other additives.</p>

I: Inspect and if necessary, adjust, correct, clean or replace.

R: Replace or change

Number of months or driving distance, whichever comes first								
Months	24	48	72	96	120	144	168	192
Miles × 1,000	20	40	60	80	100	120	140	160
Km × 1,000	30	60	90	120	150	180	210	240
Engine oil and engine oil filter ¹	Replace every 15,000 km (10,000 miles) or 12 months							
Coolant (Engine) ²	At first, Replace 180,000 km (120,000 miles) or 120 months After that, Replace every 30,000 km (20,000 miles) or 24 months							
Coolant (Inverter)	HEV ³	At first, Replace 180,000 km (120,000 miles) or 120 months After that, Replace every 30,000 km (20,000 miles) or 24 months						
	PHEV ⁴	Replace every 60,000km (40,000 miles) or 36 months						
HSG (Hybrid Starter & Generator) belt ⁵	Inspect every 15,000 km (10,000 miles) or 12 months Replace every 105,000 km (70,000 miles) or 48 months							
Spark plugs ⁶	Replace every 150,000 km (100,000 miles)							
Dual clutch transmission (DCT) fluid ⁷	No check, No service required							
Engine clutch actuator fluid	R	R	R	R	R	R	R	R
Engine clutch actuator hose and line	I	I	I	I	I	I	I	I
Drive shaft and boots	I	I	I	I	I	I	I	I
Fuel additives ⁸	Add every 15,000 km (10,000 miles) or 12 months							
Fuel lines, hoses and connections	-	I	-	I	-	I	-	I
Fuel tank air filter	-	I	-	I	-	I	-	I
Vapor hose and fuel filler cap	-	I	-	I	-	I	-	I
Air cleaner filter	I	R	I	R	I	R	I	R
Exhaust system	I	I	I	I	I	I	I	I
Cooling system	I	I	I	I	I	I	I	I
Air conditioner compressor/refrigerant	I	I	I	I	I	I	I	I
Climate control air filter	R	R	R	R	R	R	R	R
Brake discs and pads	I	I	I	I	I	I	I	I
Brake lines, hoses and connections	I	I	I	I	I	I	I	I
Brake fluid	R	R	R	R	R	R	R	R
Steering gear rack, linkage and boots	I	I	I	I	I	I	I	I
Suspension ball joints	I	I	I	I	I	I	I	I
Tire (pressure & tread wear)	I	I	I	I	I	I	I	I
Battery (12V) condition	I	I	I	I	I	I	I	I
Pan-European eCall system battery (if equipped)	Replace every 4 years							

Maintenance under severe usage conditions - for Europe

I: Inspect and if necessary, adjust, correct, clean or replace.

R: Replace or change.

Maintenance item	Maintenance operation	Maintenance intervals	Driving condition
Engine oil and engine oil filter	R	Every 7,500 km (5,000 miles) or 6 months	A, B, C, D, E, F, G, H, I, J, K, L
HSG (Hybrid Starter& Generator) belt	R	Every 45,000 km (30,000 miles) or 24 months	B, C, D, E, I, K
	I	Every 7,500 km (5,000 miles) or 6 months	
Spark plugs	R	More frequently	A, B, F, G, H, I, K
Dual clutch transmission (DCT) fluid	R	Every 120,000 km (80,000 miles)	C, D, F, G, H, I, J
Drive shaft and boots	I	More frequently	C, D, E, F, G, H, I, J
Air cleaner filter	R	More frequently	C, E
Climate control air filter	R	More frequently	C, E, G
Brake discs and pads and calipers	I	More frequently	C, D, E, G, H, I, J, K
Steering gear rack, linkage and boots	I	More frequently	C, D, E, F, G
Suspension ball joints	I	More frequently	C, D, E, G, H, I

A: Repeated driving short distance of less than 8 km (5 miles) in normal temperature or less than 16 km (10 miles) in freezing temperature

B: Extensive engine idling or low speed driving for long distances

C: Driving on rough, dusty, muddy, unpaved, graveled or salt-spread roads

D: Driving in areas using salt or other corrosive materials or in very cold weather

E: Driving in heavy dust condition

F: Driving in heavy traffic area

G: Driving on uphill, downhill, or mountain road repeatedly

H: Using for towing or camping and driving with loading on the roof

I: Driving as a patrol car, taxi, other commercial use of vehicle towing

J: Frequently driving under high speed or rapid acceleration/deceleration

K: Frequently driving in stop-and-go condition

L: Engine oil usage which is not recommended (Mineral type, Semi-synthetic, Lower grade spec, etc.).

Normal maintenance schedule - except Europe

The following maintenance services must be performed to ensure good emission control and performance. Keep receipts for all vehicle emission services to protect your warranty. Where both mileage and time are shown, the frequency of service is determined by whichever occurs first.

NO.	Item	Remark
*1	Engine oil and engine oil filter	<ul style="list-style-type: none"> As it is normal for engine oil to be consumed during driving, the engine oil level should be checked on regular basis. The engine oil change interval for normal operating conditions is based on the use of the recommended engine specification. If the recommended engine oil specification is not used, then replace the engine oil according to the maintenance schedule under severe operating conditions.
*2	Coolant (Engine)	When adding coolant, use only deionized water or soft water for your vehicle and never mix hard water in the coolant filled at the factory. An improper coolant mixture can result in serious malfunction or engine damage.
*3	Coolant (HEV Inverter)	When adding coolant, use only deionized water or soft water for your vehicle and never mix hard water in the coolant filled at the factory. An improper coolant mixture can result in serious malfunction or engine damage.
*4	Coolant (PHEV Inverter)	Recommend that the coolant be replaced by an authorized Kia dealer/service partner.
*5	HSG (Hybrid Starter & Generator) belt	Inspect HSG belt for evidence of cuts, cracks, excessive wear or oil saturation and replace if necessary.
*6	Spark plug	For your convenience, it can be replaced prior to it's interval when you do maintenance of other items.
*7	Dual clutch transmission (DCT) fluid	Dual clutch transmission (DCT) fluid should be changed anytime it has been submerged in water.
*8	Fuel additives	<p>Kia recommends that you use unleaded gasoline which has an octane rating of RON (Research Octane Number) 95 / AKI (Anti Knock Index) 91 or higher (for Europe) or Octane Rating of RON (Research Octane Number) 91 / AKI (Anti-Knock Index) 87 or higher (except Europe).</p> <p>For customers who do not use good quality gasolines including fuel additives regularly, and have problems starting or the engine does not run smoothly, one bottle of additives should be added to the fuel tank when the engine oil is replaced. Additives are available from a professional workshop along with information on how to use them. Kia recommends to visit an authorized Kia dealer/service partner. Do not mix other additives.</p>

I: Inspect and if necessary, adjust, correct, clean or replace.

R: Replace or change

Number of months or driving distance, whichever comes first		12	24	36	48	60	72	84	96
Months		10	20	30	40	50	60	70	80
Miles × 1,000		15	30	45	60	75	90	105	120
Km × 1,000									
Engine oil and engine oil filter ¹	Except Middle East, India, Libya, Algeria, Morocco, Tunisia, Sudan, Egypt, Iran, Central & South America, Brazil, Mexico, China	Replace every 15,000 km (10,000 miles) or 12 months							
	For Middle East, India, Libya, Algeria, Morocco, Tunisia, Sudan, Egypt, Iran, Central & South America, Brazil	Replace every 10,000 km (6,500 miles) or 12 months							
	For Mexico	Replace every 10,000 km (6,500 miles) or 6 months							
	For China	Replace every 5,000 km (3,000 miles) or 6 months							
Coolant (Engine) ²		At first, Replace 180,000 km (120,000 miles) or 120 months After that, Replace every 30,000 km (20,000 miles) or 24 months							
Coolant (Inverter)	HEV ³	At first, Replace 180,000 km (120,000 miles) or 120 months After that, Replace every 30,000 km (20,000 miles) or 24 months							
	PHEV ⁴	Replace every 60,000km (40,000 miles) or 36 months							
HSG (Hybrid Starter & Generator) belt ⁵	Except Middle East, India, Libya, Algeria, Morocco, Tunisia, Sudan, Egypt, Iran, Central & South America, Brazil, Mexico, China	Inspect every 15,000 km (10,000 miles) or 12 months Replace every 105,000 km (70,000 miles) or 48 months							
	For Middle East, India, Libya, Algeria, Morocco, Tunisia, Sudan, Egypt, Iran, Central & South America, Brazil, Mexico, China	Inspect every 10,000 km (6,500 miles) or 12 months Replace every 100,000 km (65,000 miles) or 48 months							
Spark plugs ⁶		Replace every 150,000 km (100,000 miles)							
Dual clutch transmission (DCT) fluid ⁷		No check, No service required							
Engine clutch actuator fluid		Replace every 40,000 km (26,000 miles) or 24 months							
Engine clutch actuator hose and line		I	I	I	I	I	I	I	I
Drive shaft and boots		-	I	-	I	-	I	-	I
Fuel additives ⁸	Except Middle East, India, Libya, Algeria, Morocco, Tunisia, Sudan, Egypt, Iran, Central & South America, Brazil, Mexico, China	Add every 15,000 km (10,000 miles) or 12 months							
	For Middle East, India, Libya, Algeria, Morocco, Tunisia, Sudan, Egypt, Iran, Central & South America, Brazil	Add every 10,000 km (6,500 miles) or 12 months							
	For Mexico	Add every 10,000 km (6,500 miles) or 6 months							
	For China	Add every 5,000 km (3,000 miles) or 6 months							
Fuel filter (Gasoline)	For China, Brazil	-	I	-	R	-	I	-	R
Fuel lines, hoses and connections		-	-	-	I	-	-	-	I

Number of months or driving distance, whichever comes first								
Months	12	24	36	48	60	72	84	96
Miles × 1,000	10	20	30	40	50	60	70	80
Km × 1,000	15	30	45	60	75	90	105	120
Fuel tank air filter	-	I	-	R	-	I	-	R
Vapor hose and fuel filler cap	-	-	-	I	-	-	-	I
Air cleaner filter	Except China, India, Middle East	I	I	R	I	I	R	I
	For China, India, Middle East	R	R	R	R	R	R	R
Exhaust system	-	I	-	I	-	I	-	I
Cooling system	I	I	I	I	I	I	I	I
Air conditioner compressor/refrigerant	I	I	I	I	I	I	I	I
Climate control air filter	Except Australia and New Zealand	R	R	R	R	R	R	R
	For Australia and New Zealand	I	R	I	R	I	R	I
Brake discs and pads	-	I	-	I	-	I	-	I
Brake lines, hoses and connections	-	I	-	I	-	I	-	I
Brake fluid	Except Australia and New Zealand	I	I	R	I	I	R	I
	For Australia and New Zealand	I	R	I	R	I	R	I
Steering gear rack, linkage and boots	I	I	I	I	I	I	I	I
Suspension ball joints	I	I	I	I	I	I	I	I
Tire (pressure & tread wear)	I	I	I	I	I	I	I	I
Battery (12V) condition	I	I	I	I	I	I	I	I
UAE eCall system battery (if equipped)	Replace every 4 years							

Maintenance under severe usage conditions- except Europe

I: Inspect and if necessary, adjust, correct, clean or replace.

R: Replace or change

	Maintenance item	Maintenance operation	Maintenance intervals	Driving condition
Engine oil and engine oil filter	Except Middle East, India, Libya, Algeria, Morocco, Tunisia, Sudan, Egypt, Iran, Central & South America, Brazil, Mexico, China	R	Every 7,500 km (5,000 miles) or 6 months	A, B, C, D, E, F, G, H, I, J, K, L
	For Middle East, India, Libya, Algeria, Morocco, Tunisia, Sudan, Egypt, Iran, Central & South America, Brazil		Every 5,000 km (3,000 miles) or 6 months	
	For Mexico, China		Every 5,000 km (3,000 miles) or 3 months	
HSG (Hybrid Starter & Generator) belt	Except Middle East, India, Libya, Algeria, Morocco, Tunisia, Sudan, Egypt, Iran, Central & South America, Brazil, Mexico, China	R	Every 45,000 km (30,000 miles) or 24 months	B, C, D, E, I, K
		I	Every 7,500 km (5,000 miles) or 6 months	
	R	Every 50,000 km (32,500 miles) or 24 months		
	I	Every 5,000 km (3,000 miles) or 6 months		
Spark plugs		R	More frequently	A, B, F, G, H, I, K
Dual clutch transmission (DCT) fluid		R	Every 120,000 km (80,000 miles)	C, D, F, G, H, I, J
Drive shaft and boots		I	More frequently	C, D, E, F, G, H, I, J
Air cleaner filter		R	More frequently	C, E
Climate control air filter		R	More frequently	C, E, G
Brake discs and pads and calipers		I	More frequently	C, D, E, G, H, I, J, K
Steering gear rack, linkage and boots		I	More frequently	C, D, E, F, G
Suspension ball joints		I	More frequently	C, D, E, G, H, I

- A: Repeatedly driving short distance of less than 8 km (5 miles) in normal temperature or less than 16 km (10 miles) in freezing temperature.
- B: Extensive engine idling or low speed driving for long distances.
- C: Driving on rough, dusty, muddy, unpaved, graveled or saltspread roads.
- D: Driving in areas using salt or other corrosive materials or in very cold weather
- E: Driving in heavy dust condition.
- F: Driving in heavy traffic area.
- G: Driving on uphill, downhill, or mountain roads repeatedly.
- H: Using for towing or camping and driving with loading on the roof.
- I: Driving as a patrol car, taxi, other commercial use of vehicle towing.
- J: Frequently driving under high speed or rapid acceleration/deceleration.
- K: Frequently driving in stop-and-go conditions.
- L: Engine oil usage which is not recommended (Mineral type, Semi-synthetic, Lower grade spec, etc.)

Normal maintenance schedule - for Australia and New Zealand

The following maintenance services must be performed to ensure good emission control and performance. Keep receipts for all vehicle emission services to protect your warranty. Where both mileage and time are shown, the frequency of service is determined by whichever occurs first.

NO.	Item	Remark
*1	Engine oil and engine oil filter	<ul style="list-style-type: none"> As it is normal for engine oil to be consumed during driving, the engine oil level should be checked on regular basis. The engine oil change interval for normal operating conditions is based on the use of the recommended engine specification. If the recommended engine oil specification is not used, then replace the engine oil according to the maintenance schedule under severe operating conditions.
*2	Coolant (Engine)	When adding coolant, use only deionized water or soft water for your vehicle and never mix hard water in the coolant filled at the factory. An improper coolant mixture can result in serious malfunction or engine damage.
*3	Coolant (HEV Inverter)	When adding coolant, use only deionized water or soft water for your vehicle and never mix hard water in the coolant filled at the factory. An improper coolant mixture can result in serious malfunction or engine damage.
*4	Coolant (PHEV Inverter)	Recommend that the coolant be replaced by an authorised Kia dealer/service partner.
*5	HSG (Hybrid Starter & Generator) belt	Inspect HSG belt for evidence of cuts, cracks, excessive wear or oil saturation and replace if necessary.
*6	Spark plug	For your convenience, it can be replaced prior to its interval when you do maintenance of other items.
*7	Dual clutch transmission (DCT) fluid	Dual clutch transmission (DCT) fluid should be changed anytime it has been submerged in water.
*8	Fuel additives	<p>Kia recommends that you use unleaded petrol which has an octane rating of RON (Research Octane Number) 95 / AKI (Anti Knock Index) 91 or higher (for Europe) or Octane Rating of RON (Research Octane Number) 91 / AKI (Anti-Knock Index) 87 or higher (except Europe).</p> <p>For customers who do not use good quality petrols including fuel additives regularly, and have problems starting or the engine does not run smoothly, one bottle of additives should be added to the fuel tank when the engine oil is replaced. Additives are available from a professional workshop along with information on how to use them. Kia recommends to visit an authorised Kia dealer/service partner. Do not mix other additives.</p>

I: Inspect and if necessary, adjust, correct, clean or replace.

R: Replace or change

Number of months or driving distance, whichever comes first									
Months		12	24	36	48	60	72	84	96
Km × 1,000		15	30	45	60	75	90	105	120
Engine oil and engine oil filter ¹		R	R	R	R	R	R	R	R
Coolant (Engine) ²		At first, Replace 180,000 km or 120 months After that, Replace every 30,000 km or 24 months							
Coolant (Inverter)	HEV ³	At first, Replace 180,000 km or 120 months After that, Replace every 30,000 km or 24 months							
	PHEV ⁴	Replace every 60,000km or 36 months							
HSG (Hybrid Starter & Generator) belt ⁵		Inspect every 15,000 km or 12 months Replace every 105,000 km or 48 months							
Spark plugs ⁶		Replace every 150,000 km							
Dual clutch transmission (DCT) fluid ⁷		No check, No service required							
Engine clutch actuator fluid		Replace every 40,000 km or 24 months							
Engine clutch actuator hose and line		I	I	I	I	I	I	I	I
Drive shaft and boots		-	I	-	I	-	I	-	I
Fuel additives ⁸		Add every 15,000 km or 12 months							
Fuel lines, hoses and connections		-	-	-	I	-	-	-	I
Fuel tank air filter		-	I	-	R	-	I	-	R
Vapour hose and fuel filler cap		-	-	-	I	-	-	-	I
Air cleaner filter		I	I	R	I	I	R	I	I
Exhaust system		-	I	-	I	-	I	-	I
Cooling system		I	I	I	I	I	I	I	I
Air conditioner compressor/refrigerant		I	I	I	I	I	I	I	I
Climate control air filter		I	R	I	R	I	R	I	R
Brake discs and pads		-	I	-	I	-	I	-	I
Brake lines, hoses and connections		-	I	-	I	-	I	-	I
Brake fluid		I	R	I	R	I	R	I	R
Steering gear rack, linkage and boots		I	I	I	I	I	I	I	I
Suspension ball joints		I	I	I	I	I	I	I	I
Tire (pressure & tread wear)		I	I	I	I	I	I	I	I
Battery (12V) condition		I	I	I	I	I	I	I	I

Maintenance under severe usage conditions- for Australia and New Zealand

I: Inspect and if necessary, adjust, correct, clean or replace.

R: Replace or change

Maintenance item	Maintenance operation	Maintenance intervals	Driving condition
Engine oil and engine oil filter	R	Every 7,500 km or 6 months	A, B, C, D, E, F, G, H, I, J, K, L
HSG (Hybrid Starter & Generator) belt	R	Every 45,000 km or 24 months	B, C, D, E, I, K
	I	Every 7,500 km or 6 months	
Spark plugs	R	More frequently	A, B, F, G, H, I, K
Dual clutch transmission (DCT) fluid	R	Every 120,000 km	C, D, F, G, H, I, J
Drive shaft and boots	I	More frequently	C, D, E, F, G, H, I, J
Air cleaner filter	R	More frequently	C, E
Climate control air filter	R	More frequently	C, E, G
Brake discs and pads and calipers	I	More frequently	C, D, E, G, H, I, K
Steering gear rack, linkage and boots	I	More frequently	C, D, E, F, G
Suspension ball joints	I	More frequently	C, D, E, G, H, I

A: Repeatedly driving short distance of less than 8 km in normal temperature or less than 16 km in freezing temperature.

B: Extensive engine idling or low speed driving for long distances.

C: Driving on rough, dusty, muddy, unpaved, graveled or saltspread roads.

D: Driving in areas using salt or other corrosive materials or in very cold weather

E: Driving in heavy dust condition.

F: Driving in heavy traffic area.

G: Driving on uphill, downhill, or mountain roads repeatedly.

H: Using for towing or camping and driving with loading on the roof.

I: Driving as a patrol car, taxi, other commercial use of vehicle towing.

J: Frequently driving under high speed or rapid acceleration/deceleration.

K: Frequently driving in stop-and-go conditions.

L: Engine oil usage which is not recommended (Mineral type, Semi-synthetic, Lower grade spec, etc.)

Explanation of scheduled maintenance items

Engine oil and filter

The engine oil and filter should be changed at the intervals specified in the maintenance schedule. If the vehicle is being driven in severe conditions, more frequent oil and filter changes are required.

Hybrid Starter & Generator (HSG) belt

Inspect all hybrid starter & generator belts for evidence of cuts, cracks, excessive wear or oil saturation and replace if necessary. Hybrid starter & generator belts should be checked periodically for proper tension and adjusted as necessary.

CAUTION

When you are inspecting the belt, place the ignition switch in the LOCK/OFF or ACC position.

Fuel filter

Kia gasoline vehicles are equipped a lifetime fuel filter that integrated with the fuel tank. Regular maintenance or replacement is not needed but depends on fuel quality. If there are some important safety matters like fuel flow restriction, surging, loss of power, hard starting problem etc, fuel filter inspection or replace is needed.

Have the fuel filter inspected or replaced by a professional workshop. Kia recommends to visit an authorized Kia dealer/service partner.

Fuel lines, fuel hoses and connections

Check the fuel lines, fuel hoses and connections for leakage and damage. Have the fuel lines, fuel hoses and connections replaced by a professional workshop. Kia recommends to visit an authorized Kia dealer/service partner.

Vapor hose and fuel filler cap

The vapor hose and fuel filler cap should be inspected at those intervals specified in the maintenance schedule. Make sure that a new vapor hose or fuel filler cap is correctly replaced.

Air cleaner filter

Have the air cleaner filter replaced by a professional workshop. Kia recommends to visit an authorized Kia dealer/service partner.

Spark plugs

Make sure to install new spark plugs of the correct heat range.

When assembling parts, be sure to wipe the inside and outside of the boot bottom of the ignition coil and the insulator of the spark plug with a soft cloth to prevent contamination of the spark plug insulator.

WARNING

Do not disconnect and inspect spark plugs when the engine is hot. You may burn yourself.

Cooling system

Check the cooling system components, such as the radiator, coolant reservoir, hoses and connections for leakage and damage. Replace any damaged parts.

Coolant/inverter coolant

The coolant should be changed at the intervals specified in the maintenance schedule.

Dual clutch transmission (DCT) fluid

Inspect the dual clutch transmission fluid according to the maintenance schedule.

Brake hoses and lines

Visually check for proper installation, chafing, cracks, deterioration and any leakage. Replace any deteriorated or damaged parts immediately.

Brake fluid

Check the brake fluid level in the brake fluid reservoir. The level should be between "MIN" and "MAX" marks on the side of the reservoir. Use only hydraulic brake fluid conforming to DOT 4 specification.

Brake discs, pads and calipers

Check the pads for excessive wear, discs for run out and wear, and calipers for fluid leakage.

For more information on checking the pads or lining wear limit, we recommend to refer to the Kia web site.

(www.kia-hotline.com)

Suspension mounting bolts

Check the suspension connections for looseness or damage. Retighten to the specified torque.

Steering gear box, linkage & boots/lower arm ball joint

With the vehicle stopped and engine off, check for excessive free-play in the steering wheel.

Check the linkage for bends or damage. Check the dust boots and ball joints for deterioration, cracks, or damage. Replace any damaged parts.

Drive shafts and boots

Check the drive shafts, boots and clamps for cracks, deterioration, or damage. Replace any damaged parts and, if necessary, repack the grease.

Air conditioning refrigerant

Check the air conditioning lines and connections for leakage and damage.

Checking fluid levels

When checking engine oil, engine coolant, brake fluid, and washer fluid, always be sure to clean the area around any filler plug, drain plug, or dipstick before checking or draining any lubricant or fluid. This is especially important in dusty or sandy areas and when the vehicle is used on unpaved roads. Cleaning the plug and dipstick areas will prevent dirt and grit from entering the engine and other mechanisms that could be damaged.

Engine oil

Checking engine oil level

Engine oil is used for lubricating, cooling, and operating various hydraulic components in the engine. Engine oil consumption while driving is normal, and it is necessary to check and refill the engine oil regularly. Also, check and refill the oil level within the recommended maintenance schedule to prevent deterioration of oil performance.

Check the engine oil following the below procedure.

Smartstream G1.6 GDi HEV/PHEV

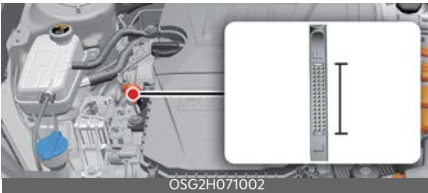

Operation

1. Be sure the vehicle is on level ground.
2. Start the engine and allow it to reach normal operating temperature.
3. Turn the engine off, remove the oil filler cap and pull the dipstick out. Wait for 15 minutes for the oil to return to the oil pan.
4. Wipe the dipstick clean and re-insert it fully.
5. Pull the dipstick out again and check between the F-L line, and if it is below the L line, add enough oil to bring the level to F line.

Replenishing engine oil

Smartstream G1.6 GDi HEV/PHEV



Use a funnel to help prevent oil from being spilled on engine components.

Use only the specified engine oil. (Refer to "Recommended lubricants and capacities" on page 9-6.)

- Do not spill engine oil when adding or changing engine oil. Wipe off spilled oil immediately.
- The engine oil consumption may increase while you break in a new vehicle and it will be stabilized after driving 6,000 km (4,000 miles).
- The engine oil consumption can be affected by driving habits, climate conditions, traffic conditions, oil quality, etc. Therefore, it is recommended that you inspect the engine oil level regularly and refill it if necessary.

Changing engine oil and filter

Have the engine oil and filter replaced by a professional workshop. Kia recommends to visit an authorized Kia dealer/service partner.

- If the maintenance schedule to replace engine oil is exceeded, the engine oil performance may deteriorate, and the engine condition may be affected. Therefore, replace the engine oil according to the maintenance schedule.
- To keep the engine in optimal condition, use the recommended engine oil and filter. If the recommended engine

oil and filter are not used replace it according to the maintenance schedule under severe usage conditions.

- * The purpose of the maintenance schedule for engine oil replacement is to prevent oil deterioration and it is irrelevant to oil consumption. Check and refill engine oil regularly.

WARNING

- Be very careful not to touch the radiator hose when checking or adding the engine oil as it may be hot enough to burn you.
- Used engine oil may cause irritation or cancer of the skin if left in contact with the skin for prolonged periods of time. Used engine oil contains chemicals that have caused cancer in laboratory animals. Always protect your skin by washing your hands thoroughly with soap and warm water as soon as possible after handling used oil. Do not leave used engine oil within the reach of children.

CAUTION

- When you wipe the oil level gauge, you should wipe it with a clean cloth. When mixed with debris, it can cause engine damage.
- The engine oil is very hot immediately after the vehicle has been driven and can cause burns during replacement. Replace the engine oil after the engine oil has cooled down.

* NOTICE

When the oil pressure is low due to insufficient engine oil, the Engine Oil Pressure () warning light will illuminate.

In addition, the enhanced engine protection system, which limits the engine's power is activated and the Malfunction Indicator Lamp () will illuminate when the vehicle is driven in this state continuously.

When oil pressure is restored, the Engine Oil Pressure warning light will turn off and the engine power will no longer be limited.

Engine coolant

Checking coolant level



Check the condition and connections of all cooling system hoses and heater hoses. Replace any swollen or deteriorated hoses.

The coolant level should be filled between MAX and MIN (F and L) marks on the side of the coolant reservoir when the engine is cool.

* INFORMATION

If frequent additions are required, have the system inspected by a professional workshop. Kia recommends to visit an authorized Kia dealer/service partner.

⚠ WARNING



The electric motor (cooling fan) is controlled by engine coolant temperature, refrigerant pressure and vehicle speed. It may sometimes operate even when the engine is not running. Use extreme caution when working near the blades of the cooling fan so that you are not injured by a rotating fan blades. As the engine coolant temperature decreases, the electric motor will automatically shut off. This is a normal condition. The electric motor (cooling fan) may operate until you disconnect the negative battery cable.

⚠ CAUTION



- Never attempt to remove the coolant reservoir cap while the engine is operating or hot. Doing so might lead to cooling system and engine damage. Also, hot coolant or steam could cause serious personal injury. Turn the engine off and wait until it cools down. Use extreme care when removing the coolant reservoir cap. Wrap a thick towel around it, and turn in slowly to the first stop. Step back while the pressure is released from the cooling system. When you are sure all the pressure has been released, press down on the cap, using a thick towel, and continue turning to remove it. Even if the engine is not operating, do not remove the coolant reservoir cap or the drain plug while the engine and radiator are hot. Hot coolant and steam may still blow out under pressure, causing serious injury.

- When the engine overheats from low engine coolant, suddenly adding engine coolant may cause cracks in the engine. To prevent damage, add engine coolant slowly in small quantities.
- Do not drive with no engine coolant. It may cause water pump failure and engine seizure, etc.

* NOTICE

Make sure the coolant cap is properly closed after refill of coolant. Otherwise the engine could be overheated while driving.

Operation

1. Check if the coolant reservoir cap label is straight In front.



2. Make sure that the tiny protrusions inside the coolant cap are securely interlocked.

Recommended engine coolant

- When adding coolant, use only deionized water or soft water for your vehicle and never mix hard water in the coolant filled at the factory.
- Do not use alcohol or methanol coolant or mix them with the specified coolant.
- Do not use a solution that contains more than 60% antifreeze or less than 35% antifreeze.

Refer to the following table for mixture percentage.

Ambient Temperature	Mixture Percentage (volume)	
	Antifreeze	Water
-15°C (5°F)	35	65
-25°C (-13°F)	40	60
-35°C (-31°F)	50	50
-45°C (-49°F)	60	40

⚠ WARNING



• Do not remove the coolant reservoir cap when the engine and radiator are hot. Scalding hot coolant and steam may blow out under pressure causing serious injury.

- Do not use radiator coolant or anti-freeze in the washer fluid reservoir.
- Radiator coolant can severely obscure visibility when sprayed on the windshield and may cause loss of vehicle control or damage the paint and body trim.

Checking the inverter coolant level (HEV)

If frequent additions are required, we recommend that the system be inspected by a professional workshop. Kia recommends to visit an authorized Kia dealer/service partner.

The inverter coolant level should be in between MAX and MIN when the engine is cooled down.

⚠ WARNING

Adding other cooling substances or water might lead to inverter cooling system degradation or even failure.



- Turn the vehicle off and wait until it cools down.
- Use extreme care when removing the inverter coolant reservoir cap. Wrap a thick towel around it, and turn it slowly to the first stop.
- Step back while the pressure is released from the cooling system.
- When you are sure all the pressure has been released, press down on the cap, using a thick towel, and continue turning to remove it.

- Check the condition and connections of all cooling system hoses and heater hoses.
- Replace any swollen or deteriorated hoses.
- Check the coolant level. The coolant level should be filled between MAX and MIN marks on the side of the coolant reservoir when the engine room is cool.
- If the coolant level is low, add enough specified coolant to provide protection against freezing and corrosion. Bring the level to MAX, but do not overfill.

WARNING

Make sure the inverter coolant reservoir cap is properly closed after refill or coolant.

Otherwise the inverter could be overheated while driving.

1. Check if the inverter coolant reservoir cap label is straight In front.



2. Make sure that the tiny protrusions inside the inverter coolant reservoir cap are securely interlocked.

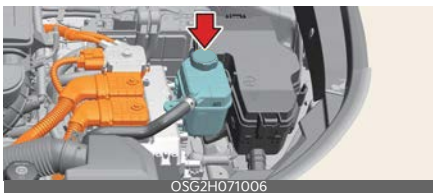

WARNING



Removing inverter coolant reservoir cap

Never remove the inverter coolant reservoir cap while the engine and radiator are hot. Hot coolant and steam may blow out under pressure, causing serious injury.

Checking the inverter coolant level (PHEV)

If frequent additions are required, we recommend that the system be inspected by a professional workshop. Kia recommends to visit an authorized Kia dealer/service partner.

The inverter coolant level should be in between MAX and MIN when the engine is cooled down. When the coolant level (in the reservoir) is low, we recommend that you contact your authorized Kia dealer/service partner. Use only designated coolant water for electric vehicles.

WARNING

Adding other cooling substances or water might lead to inverter cooling system degradation or even failure.

Changing the coolant

We recommend that the coolant be replaced by an authorized Kia dealer according to the Maintenance Schedule at the beginning of this chapter.

WARNING



Cooling fan

Use caution when working near the blade of the cooling fan. The electric motor (cooling fan) is controlled by coolant temperature, refrigerant pressure and vehicle speed. It may sometimes operate even when the vehicle is not running.

Changing coolant

Have the coolant replaced by a professional workshop. Kia recommends to visit an authorized Kia dealer/service partner.

CAUTION

Put a thick cloth around the coolant reservoir cap before refilling the coolant in order to prevent the coolant from overflowing into engine parts such as the alternator.

Hybrid starter & generator (HSG) belt

Checking the Hybrid Starter & Generator (HSG) belt

We recommend that you have the Hybrid Starter & Generator (HSG) belt inspected or replaced according to the Maintenance Schedule in this chapter by an authorized Kia dealer/service partner.

CAUTION

When the HSG belt is worn out or damaged, replace the belt. Otherwise, it may cause engine overheating or battery discharge.

WARNING

- Turn the vehicle off while you inspect the engine or Hybrid Starter & Generator (HSG) belt. Otherwise it may result in serious injury.
- Keep hands, clothing etc. away from the Hybrid Starter & Generator (HSG) belt

Brake fluid

Checking brake fluid level

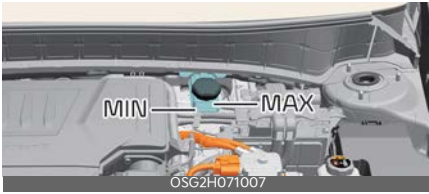

Operation

1. Clean the area around the reservoir cap.
2. Periodically check that the fluid level in the brake fluid reservoir is between MIN and MAX. The level will fall with accumulated mileage. This is a normal condition associated with the wear of the brake linings.

Check the fluid level in the reservoir periodically. The fluid level should be between MAX and MIN marks on the side of the reservoir. Never mix different types of fluid.

Use only the specified brake fluid. (Refer to "Recommended lubricants and capacities" on page 9-6.)

* INFORMATION

If the fluid level is excessively low, have the system checked by a professional workshop. Kia recommends to visit an authorized Kia dealer/service partner.

⚠ WARNING

- In the event the brake system requires frequent additions of fluid, have the system inspected by a professional workshop. Kia recommends to visit an authorized Kia dealer/service partner.
- When changing and adding brake fluid, handle it carefully. Do not let it come in contact with your eyes. If brake fluid should come in contact with your eyes, immediately flush them with a large quantity of fresh tap water. Have your eyes examined by a doctor as soon as possible.

⚠ CAUTION

Do not allow brake fluid to contact the vehicle's body paint, as paint damage will result. Brake fluid, which has been exposed to open air for an extended time should never be used as its quality cannot be guaranteed. It should be properly disposed. Don't put in the wrong kind of fluid. A few drops of mineral-based oil, such as engine oil, in your brake system can damage brake system parts.

Engine clutch actuator fluid

Checking the engine clutch actuator fluid level



In normal driving conditions, the actuator fluid level does not go down rapidly. However, oil consumption rate may rise as vehicle mileage increases, and leakage in actuator related parts may result in increased consumption of the engine clutch actuator oil. Regularly check and make sure the engine clutch actuator oil fluid level is between MIN and MAX marks.

If the oil level is below MIN mark, have the vehicle checked by a professional workshop. Kia recommends to visit an authorized Kia dealer/service partner.

If the fluid level is excessively low, have the system checked by a professional workshop. Kia recommends to visit an authorized Kia dealer/service partner.

Use only the specified engine clutch actuator fluid. (Refer to "Recommended lubricants and capacities" on page 9-6.) Never mix different types of fluid.

- Check the fluid level in the engine clutch actuator fluid reservoir and add fluid if necessary. Plain water may be used if washer fluid is not available.

The reservoir is translucent so that you can check the level with a quick visual inspection.

⚠ CAUTION

Do not allow engine clutch actuator fluid to contact the vehicle's body paint, as paint damage will result. The engine clutch actuator fluid, which has been exposed to open air for an extended time should never be used as its quality cannot be guaranteed. It should be properly disposed. Don't put in the wrong kind of fluid. A few drops of mineral-based oil, such as engine oil, in your engine clutch system can damage engine clutch system parts.

⚠ WARNING

- In the event the engine clutch system requires frequent additions of fluid, have the system inspected by a professional workshop. Kia recommends to visit an authorized Kia dealer/service partner.
- When changing and adding the engine clutch actuator fluid, handle it carefully. Do not let it come in contact with your eyes. If engine clutch actuator fluid should come in contact with your eyes, immediately flush them with a large quantity of fresh tap water. Have your eyes examined by a doctor as soon as possible.

Washer fluid

Checking washer fluid level



Operation

- Check the fluid level in the washer fluid reservoir and add fluid if necessary. Plain water may be used if washer fluid is not available.

However, use washer solvent with antifreeze characteristics in cold climates to prevent freezing.

The reservoir is translucent so that you can check the level with a quick visual inspection.

⚠ WARNING

- Do not use radiator coolant or anti-freeze in the washer fluid reservoir.
- Radiator coolant can severely obscure visibility when sprayed on the windshield and may cause loss of vehicle control or damage to paint and body trim.
- Windshield washer fluid agents contain some amounts of alcohol and can be flammable under certain circumstances. Do not allow sparks or flame to contact the washer fluid or the washer fluid reservoir. Damage to the vehicle or occupants could occur.
- Windshield washer fluid is poisonous to humans and animals. Do not drink and avoid contacting windshield washer fluid. Serious injury or death could occur.

Air cleaner filter

Replacing air cleaner filter

Operation

1. Loosen the air cleaner cover attaching clips (1) and open the cover (2).



2. Wipe the inside of the air cleaner. Replace air cleaner filter.



3. Lock the cover with the cover attaching clips. Assemble in reverse order.

⚠ CAUTION

- Do not drive with the air cleaner removed; this will result in excessive engine wear.
- When removing the air cleaner filter, be careful that dust or dirt does not enter the air intake, or damage may result.
- Use parts for replacement from a professional workshop. Kia recommends to visit an authorized Kia dealer/service partner.

Climate control air filter

Replacing climate control air filter

Operation

1. Open the glove box and remove the stopper (1).

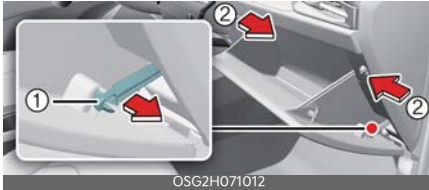

2. With the glove box open, remove the glove box by pushing the both sides of it (2).

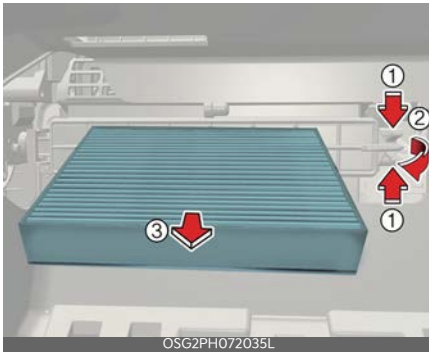

3. Remove the climate control air filter cover (2) by pulling out both sides (1) of the cover.



4. Replace the climate control air filter (3).
5. Assemble in reverse order.

* NOTICE

- When replacing the climate control air filter install it properly. Otherwise, the system may produce noise and the effectiveness of the filter may be reduced.
- If the vehicle is operated in extremely dusty or sandy areas, replace the element more often than the usual recommended intervals.

Wiper blades

Replacing front wiper blade



Operation

1. Turn off the vehicle.
2. Move the wiper switch to the single wiping (MIST/1x) position.
3. Hold the wiper switch for more than 2 seconds.
4. Type A (if equipped)
 - Raise the wiper arm.
 - Lift the wiper blade clip up. Pull down the blade assembly and remove it.



- Install the new blade assembly.



5. Type B (if equipped)
 - Raise the wiper arm and turn the wiper blade assembly to expose the plastic locking clip.



- Compress the clip and slide the blade assembly downward.



- Lift it off the arm.
 - Install the blade assembly in the reverse order of removal.
6. Install the new blade assembly.

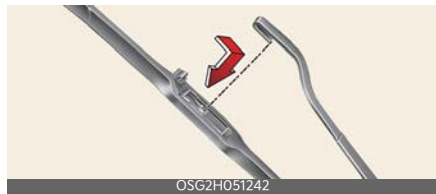

7. Return the wiper arm on the wind-shield.
8. Turn the vehicle on and wiper arms will return to the normal operating position.

Replacing rear wiper blade



Operation

1. Turn off the vehicle.
2. Move the wiper switch to the single wiping (MIST/1x) position.
3. Hold the wiper switch for more than 2 seconds.
4. Raise the wiper arm and pull out the wiper blade assembly.



5. Lift up the wiper blade, and pull the blade to remove it.



6. Install the new blade assembly by inserting the center part into the slot in the wiper arm until it clicks into place.

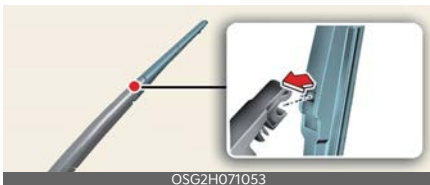

If the replacement is complete, put down the wiper arm to place it on the rear windshield, and turn the vehicle to ON position and operate the wipers to check the blade is installed correctly.

7. Make sure the blade assembly is installed firmly by trying to pull it slightly.

* INFORMATION

To prevent damage to the wiper arms or other components, have the wiper blade replaced by a professional workshop. Kia recommends to visit an authorized Kia dealer/service partner.

⚠ CAUTION

- Do not use gasoline, kerosene, paint thinner, or other solvents on or near them.
- Do not attempt to move the wipers manually.
- The use of a non-specified wiper blade could result in wiper malfunction and failure.
- Do not allow the wiper arm to fall against the windshield, since it may chip or crack the windshield.
- If the wiper arm receives too much force while pulling the blade, the center part may be damaged.
- The wiper could not operate for approximately 10 seconds when the wiper is operated without washer fluid or the blades are frozen. This is not a malfunction, it is a wiper protection system activated by motor overload circuit within the wiper motor.
- The front windshield should be cleaned with water hose and wiped with clean towel with wiper blades raised up. Also, the wiper blades

should be wiped clean when the grease or wax is applied to the blades.

*** NOTICE**

Commercial hot waxes applied by automatic car washes have been known to make the windshield difficult to clean. And it is the responsibility of customers to wash and manage the vehicle with adequate methods and materials.

Battery (Plug-in hybrid)

For best battery service



- * The battery is located in the right side of the luggage room.
- Keep the battery securely mounted.
- Keep the battery top clean and dry.
- Keep the terminals and connections clean, tight, and coated with petroleum jelly or terminal grease.
- Rinse any spilled electrolyte from the battery immediately with a solution of water and baking soda.
- If the vehicle is not going to be used for an extended time, disconnect the battery cables.

⚠ WARNING



Always read the following instructions carefully when handling a battery.



Keep lighted cigarettes and all other flames or sparks away from the battery.



Hydrogen, a highly combustible gas, is always present in battery cells and may explode if ignited.



Keep batteries out of the reach of children because batteries contain highly corrosive SULFURIC ACID. Do not allow battery acid to contact your skin, eyes, clothing or paint finish.



If any electrolyte gets into your eyes, flush your eyes with clean

water for at least 15 minutes and get immediate medical attention.

If electrolyte gets on your skin, thoroughly wash the contacted area. If you feel pain or burning sensation, get medical attention immediately.



Wear eye protection when charging or working near a battery. Always provide ventilation when working in an enclosed

space.



An inappropriately disposed battery can be harmful to the environment and human health.

Dispose the battery according to your local law(s) or regulation.

- When lifting a plastic-cased battery, excessive pressure on the case may cause battery acid to leak, resulting in personal injury. Lift with a battery carrier or with your hands on opposite corners.
- Never attempt to recharge the battery when the battery cables are connected.
- The electrical ignition system works with high voltage. Never touch these components with the engine running or the vehicle is in ON position.

Failure to follow the above warnings can result in serious bodily injury or death.

⚠ CAUTION

If you connect unauthorized electronic devices to the battery, the battery may be discharged. Never use unauthorized devices.

* NOTICE

Your vehicle is equipped with maintenance free battery. If your vehicle is equipped with the battery marked with

LOWER and UPPER on the side, you can check the electrolyte level. The electrolyte level should be between LOWER and UPPER. If the electrolyte level is low, it needs to add distilled (demineralized) water (Never add sulfuric acid or other electrolyte). When refill, be careful not to splash the battery and adjacent components. And do not overfill the battery cells. It can cause corrosion on other parts. Make sure that the cell caps are tightened.

Contact a professional workshop. Kia recommends to visit an authorized Kia dealer/service partner.

Battery capacity label

Example



* The actual battery label in the vehicle may differ from the illustration.

- 1 The Kia model name of battery
- 2 The nominal capacity (in Ampere hours)
- 3 The nominal reserve capacity (in min.)
- 4 The nominal voltage
- 5 The cold-test current in amperes by SAE/EN
- 6 The cold-test current in amperes by SAE/EN

Battery recharging

Your vehicle has a maintenance-free, calcium-based battery.

- If the battery becomes discharged in a short time (because, for example, the headlights or interior lights were left on while the vehicle was not in use), run the engine for at least approximately 60 minutes while driving or at idle.

Also, connect the fully automatic regulated charger to the front jumper posts located in the engine compartment, or 12V battery located in the luggage room.

- If the battery gradually discharges because of high electric load while the vehicle is being used, recharge it at 20~30A for two hours.

WARNING

- When recharging the battery, observe the following precautions:
 - The battery must be removed from the vehicle and placed in an area with good ventilation.
 - Do not allow cigarettes, sparks, or flame near the battery.
 - Watch the battery during charging, and stop or reduce the charging rate if the battery cells begin gassing (boiling) violently or if the temperature of the electrolyte of any cell exceeds 49°C (120°F).
 - Wear eye protection when checking the battery during charging.
 - Disconnect the battery charger in the following order.
 1. Turn off the battery charger main switch.
 2. Unhook the negative clamp from the negative battery terminal.
 3. Unhook the positive clamp from the positive battery terminal.

- Before performing maintenance or recharging the battery, turn off all accessories and stop the engine.
- The negative battery cable must be removed first and installed last when the battery is disconnected.

CAUTION

Do not open or remove the cap on top of the battery. This may cause leaks of internal electrolyte that could result in severe injury.

Reset items

Items should be reset after the battery has been discharged or the battery has been disconnected.

- Auto up/down window
- Trip computer
- Climate control system
- Driver position memory system
- Integrated memory system
- Infotainment system

Tires and wheels

Tire care

For proper maintenance, safety, and maximum fuel economy, you must always maintain recommended tire inflation pressures and stay within the load limits and weight distribution recommended for your vehicle.

Recommended cold tire inflation pressures



All specifications (sizes and pressures) can be found on a label attached to the vehicle.

* INFORMATION

All tire pressures (including the spare) should be checked when the tires are cold. "Cold Tires" means the vehicle has not been driven for at least three hours or driven less than 1.6 km (one mile).

Checking tire inflation pressure

- Remove the valve cap from the tire valve stem. Press the tire gauge firmly onto the valve to get a pressure measurement. If the pressure is low, add air until you reach the recommended amount.
- If you overfill the tire, release air by pushing on the metal stem in the center of the tire valve. Be sure to put the valve caps back on the valve stems.

⚠ WARNING

- Overinflation or underinflation can reduce tire life, adversely affect vehicle handling, and lead to sudden tire failure. This could result in loss of vehicle control and potential injury.
- Severe underinflation (70 kPa (10 psi) or more) can lead to severe heat build-up, causing blowouts, tread separation and other tire failures that can result in the loss of vehicle control leading to severe injury or death. This risk is much higher on hot days and when driving for long periods at high speeds.
- Inspect your tires frequently for proper inflation as well as wear and damage. Always use a tire pressure gauge.
- Tires with too much or too little pressure wear unevenly causing poor handling, loss of vehicle control, and sudden tire failure leading to accidents, injuries, and even death. The recommended cold tire pressure for your vehicle can be found in this manual and on the tire label located on the driver's side center pillar.
- Worn tires can cause accidents. Replace tires that are worn, show uneven wear, or are damaged.
- Remember to check the pressure of your spare tire. Kia recommends that you check the spare every time you check the pressure of the other tires on your vehicle.

⚠ CAUTION

- Underinflation also results in excessive wear, poor handling and reduced fuel economy. Wheel deformation also is possible. Keep your tire pres-

tures at the proper levels. If a tire frequently needs refilling, have the system checked by a professional workshop. Kia recommends to visit an authorized Kia dealer/service partner.

- Overinflation produces a harsh ride, excessive wear at the center of the tire tread, and a greater possibility of damage from road hazards.
- Warm tires normally exceed recommended cold tire pressures by 28 to 41 kPa (4 to 6 psi). Do not release air from warm tires to adjust the pressure or the tires will be underinflated.
- Be sure to reinstall the tire inflation valve caps. Without the valve cap, dirt or moisture could get into the valve core and cause air leakage. If a valve cap is missing, install a new one as soon as possible.
- Always observe the following:
 - Check tire pressure when the tires are cold. (After vehicle has been parked for at least three hours or hasn't been driven more than 1.6 km (one mile) since startup.)
 - Check the pressure of your spare tire each time you check the pressure of other tires.
 - Never overload your vehicle. Be careful not to overload a vehicle luggage rack if your vehicle is equipped with one.
 - Worn, old tires can cause accidents. If your tread is badly worn, or if your tires have been damaged, replace them.

Tire rotation

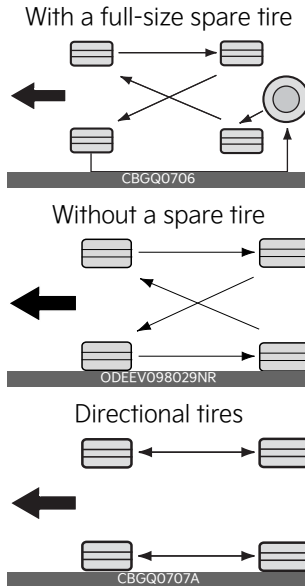

To equalize tread wear, it is recommended that the tires be rotated every 10,000 km (6,500 miles) or sooner if irregular wear develops.

WARNING

- Do not use the compact spare tire for tire rotation.
- Do not mix bias ply and radial ply tires under any circumstances. This may cause unusual handling characteristics that could result in death, severe injury, or property damage.

*** NOTICE**

Rotate radial tires that have an asymmetric tread pattern only from front to rear and not from right to left.

Wheel alignment and tire balance

The wheels on your vehicle were aligned and balanced carefully at the factory to give you the longest tire life and best overall performance.

If you notice your vehicle vibrating when driving on a smooth road, your wheels may need to be rebalanced.

⚠ CAUTION

Improper wheel weights can damage your vehicle's aluminum wheels. Use only approved wheel weights.

Tire replacement

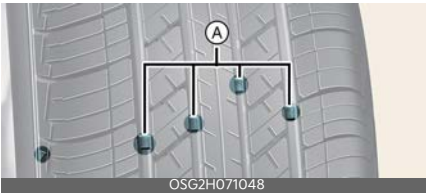

A: Tread wear indicator

If the tire is worn evenly, a tread wear Indicator will appear as a solid band across the tread.

This shows there is less than 1.6 mm (1/16 in.) of tread left on the tire. Replace the tire when this happens.

Do not wait for the band to appear across the entire tread before replacing the tire.

Compact spare tire replacement (if equipped)

A compact spare tire has a shorter tread life than a regular size tire. Replace it when you can see the tread wear indicator bars on the tire. The replacement compact spare tire should be the same size and design tire as the one provided with your new vehicle and should be

mounted on the same compact spare tire wheel. The compact spare tire is not designed to be mounted on a regular size wheel, and the compact spare tire wheel is not designed for mounting a regular size tire.

⚠ WARNING

To reduce the chance of serious or fatal injuries from an accident caused by tire failure or loss of vehicle control:

- Replace tires that are worn, show uneven wear, or are damaged. Worn tires can cause loss of braking effectiveness, steering control, and traction.
- Do not drive your vehicle with too little or too much pressure in your tires. This can lead to uneven wear and tire failure.
- When replacing tires, never mix radial and bias-ply tires on the same car. You must replace all tires (including the spare) if moving from radial to bias-ply tires.
- It is best to replace all four tires at the same time. If that is not possible, or necessary, then replace the two front or two rear tires as a pair. Replacing just one tire can seriously affect your vehicle's handling.
- Using tires and wheels other than the recommended sizes could cause unusual handling characteristics and poor vehicle control, resulting in a serious accident.
- Wheels that do not meet Kia's specifications may fit poorly and result in damage to the vehicle or unusual handling and poor vehicle control.
- The ABS works by comparing the speed of the wheels. The tire size affects wheel speed. When replacing

tires, all 4 tires must use the same size, type, construction and tread pattern originally supplied with the vehicle. Using tires of a different size can cause the ABS (Anti-lock Brake System) and ESC (Electronic Stability Control) to work irregularly.

⚠ CAUTION

When replacing the tires, recheck and tighten the wheel nuts after driving about 50 km (31 miles) and recheck after driving about 1,000 km (620 miles). If the steering wheel shakes or the vehicle vibrates while driving, the tire is out of balance. Align the tire balance. If the problem is not solved, contact a professional workshop. Kia recommends to visit an authorized Kia dealer/service partner.

* NOTICE

We recommend that when replacing tires, use the same originally supplied with the vehicles. If not, that affects driving performance.

Wheel replacement

When replacing the metal wheels for any reason, make sure the new wheels are equivalent to the original factory units in diameter, rim width and offset.

⚠ WARNING

A wheel that is not the correct size may adversely affect wheel and bearing life, braking and stopping abilities, handling characteristics, ground clearance, body-to-tire clearance, snow chain clearance, speedometer and odometer calibration, headlight aim and bumper height.

Tire traction

Tire traction can be reduced if you drive on worn tires, tires that are improperly inflated or on slippery road surfaces. Tires should be replaced when tread wear indicators appear. Slow down whenever there is rain, snow or ice on the road to reduce the possibility of losing control of the vehicle.

Tire maintenance

In addition to proper inflation, correct wheel alignment helps to decrease tire wear. If you find a tire is worn unevenly, have a professional workshop check the wheel alignment. Kia recommends to visit an authorized Kia dealer/service partner.

When you have new tires installed, make sure they are balanced. This will increase vehicle ride comfort and tire life. Additionally, a tire should always be rebalanced if it is removed from the wheel.

Tire sidewall labeling



This information identifies and describes the fundamental characteristics of the tire and also provides the tire identification number (TIN) for safety standard certification. The TIN can be used to identify the tire in case of a recall.

1. Manufacturer or brand name

2. Tire size designation

A tire's sidewall is marked with a tire size designation. You will need this information when selecting replacement tires for your vehicle. The following explains what the letters and numbers in the tire size designation mean.

Example tire size designation:
(These numbers are provided as an example only; your tire size designator could vary depending on your vehicle.)

P225/45 R18 108T

225 - Tire width in millimeters.

45 - Aspect ratio. The tire's section height as a percentage of its width.

R - Tire construction code (Radial).

18 - Rim diameter in inches.

108 - Load Index, a numerical code associated with the maximum load the tire can carry.

T - Speed Rating Symbol. See the speed rating chart in this section for additional information.

Tire speed ratings

The chart below lists many of the different speed ratings currently being used for passenger car tires. The speed rating is part of the tire size designation on the sidewall of the tire. This symbol corresponds to that tire's designed maximum safe operating speed.

Speed Rating Symbol	Maximum Speed
S	180 km/h (112 mph)
T	190 km/h (118 mph)
H	210 km/h (130 mph)
V	240 km/h (149 mph)

Speed Rating Symbol	Maximum Speed
W	270 km/h (168 mph)
Y	300 km/h (186 mph)

Wheel size designation

Wheels are also marked with important information that you need if you ever have to replace one. The following explains what the letters and numbers in the wheel size designation mean.

Example wheel size designation:

7.5JX18

7.5 - Rim width in inches.

J - Rim contour designation.

18 - Rim diameter in inches.

3. Checking tire life (TIN : Tire Identification Number)

Any tires that are over 6 years old, based on the manufacturing date, should be replaced by new ones. You can find the manufacturing date on the tire sidewall, displaying the DOT Code. The manufacturing date is designated by the last four digits (characters) of the DOT code.

DOT: XXXX XXXX 0000

The front part of the DOT means a plant code number, tire size and tread pattern and the last four numbers indicate week and year manufactured.

For example, DOT XXXX XXXX 1622 represents that the tire was produced in the 16th week of 2022.

⚠ WARNING

Tires degrade over time, even when they are not being used. Regardless of the remaining tread, we recommend that tires be replaced after approximately six (6) years of normal service. Heat caused by hot climates or frequent high loading

conditions can accelerate the aging process. Failure to follow this warning can result in sudden tire failure, which could lead to a loss of control and an accident involving serious injury or death.

4. Tire ply composition and material

The number of layers or plies of rubber-coated fabric in the tire. Tire manufacturers also must indicate the materials in the tire, which include steel, nylon, polyester, and others. The letter "R" means radial ply construction; the letter "D" means diagonal or bias ply construction; and the letter "B" means belted-bias ply construction.

5. Maximum permissible inflation pressure

This number is the greatest amount of air pressure that should be put in the tire. Do not exceed the maximum permissible inflation pressure. Refer to "Tires and wheels" on page 9-5.

6. Maximum load rating

This number indicates the maximum load in kilograms and pounds that can be carried by the tire. When replacing the tires on the vehicle, always use a tire that has the same load rating as the factory installed tire.

7. Uniform tire quality grading

Quality grades can be found where applicable on the tire sidewall between tread shoulder and maximum section width.

For example:

TREADWEAR 200
TRACTION AA
TEMPERATURE A

WARNING

- The traction grade assigned to this tire is based on straightahead braking traction tests, and does not include acceleration, cornering, hydroplaning, or peak traction characteristics.
 - The temperature grade for this tire is established for a tire that is properly inflated and not overloaded. Excessive speed, under inflation, or excessive loading, either separately or in combination, can cause heat build-up in tire and sudden tire failure. This can cause loss of vehicle control and serious injury or death.
-

Tread wear

The tread wear grade is a comparative rating based on the wear rate of the tire when tested under controlled conditions on a specified government test course. For example, a tire graded 150 would wear one-and-a-half times (1½) as well on the government course as a tire graded 100.

The relative performance of tires depends upon the actual conditions of their use, however, and may depart significantly from the norm due to variations in driving habits, service practices and differences in road characteristics and climate.

These grades are molded on the sidewalls of passenger vehicle tires. The tires available as standard or optional equipment on your vehicle may vary with respect to grade.

Traction - AA, A, B & C

The traction grades, from highest to lowest, are AA, A, B and C. Those grades represent the tire's ability to stop on wet pavement as measured under controlled conditions on specified government test surfaces of asphalt and concrete. A tire marked C may have poor traction performance.

Temperature -A, B & C

The temperature grades are A (the highest), B, and C, representing the tire's resistance to the generation of heat and its ability to dissipate heat when tested under controlled conditions on a specified indoor laboratory test wheel.

Sustained high temperature can cause the material of the tire to degenerate and reduce tire life, and excessive temperature can lead to sudden tire failure. Grades B and A represent higher levels of performance on the laboratory test wheel than the minimum required by law.

Low aspect ratio tire (if equipped)

Low aspect ratio tires, whose aspect ratio is lower than 50, are provided for sporty looks.

Because the low aspect ratio tires are optimized for handling and braking, it may be more uncomfortable to ride in and there is more noise compare with normal tires.

CAUTION

- Because the sidewall of the low aspect ratio tire is shorter than the normal, the wheel and tire of the low aspect ratio tire is easier to be damaged. So, follow the instructions below.
 - When driving on a rough road or off road, drive cautiously because tires and wheels may be damaged. And after driving, inspect tires and wheels.
 - When passing over a pothole, speed bump, manhole, or curb stone, drive slowly so that the tires and wheels are not damaged.
 - If the tire is impacted, inspect the tire condition or contact a professional workshop. Kia recommends to visit an authorized Kia dealer/ service partner.
 - To prevent damage to the tire, inspect the tire condition and pressure every 3,000 km.
- It is not easy to recognize the tire damage with your own eyes. But if there is the slightest hint of tire damage, even though you cannot see the tire damage with your own eyes, have the tire checked or replaced because the tire damage may cause air leakage from the tire.
- If the tire is damaged by driving on a rough road, off road, pothole, manhole, or curb stone, it will not be covered by the warranty.
- You can find out the tire information on the tire sidewall.

Fuses

Blade type



Cartridge type



Multi fuse



BFT

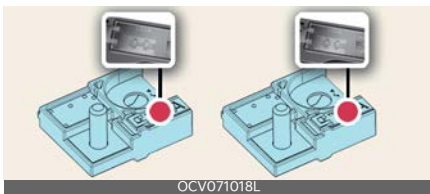

* Left: Normal, Right: Blown

* The actual fuse/relay panel label may differ.

Before replacing a blown fuse, disconnect the negative battery cable.

If the electrical system does not work, first check the driver's side fuse panel.

Always replace a blown fuse with one of the same rating.

If the replacement fuse blows, this indicates an electrical problem. Avoid using the system involved and immediately consult a professional workshop. Kia recommends to consult an authorized Kia dealer/service partner.

⚠ WARNING

- Never replace a fuse with anything but another fuse of the same rating.
- A higher capacity fuse could cause damage and possibly a fire.
- Never install a wire or aluminum foil instead of the proper fuse even as a temporary repair. It may cause extensive wiring damage and a possible fire.
- Do not arbitrarily modify or add-on electric wiring of the vehicle.

⚠ CAUTION

- When replacing a blown fuse or relay with a new one, make sure the new fuse or relay fits tightly into the clips. The incomplete fastening fuse or relay may cause the vehicle wiring and electric systems damage and a possible fire.
- Do not remove fuses, relays and terminals fastened with bolts or nuts. The fuses, relays and terminals may be fastened incompletely, and it may cause a possible fire. If fuses, relays and terminals fastened with bolts or nuts are blown, consult a professional workshop. Kia recommends to consult an authorized Kia dealer/service partner.
- Do not input any other objects except fuses or relays into fuse/relay terminals such as a driver or wiring. It may cause contact failure and system malfunction.

- Do not plug in screwdrivers or aftermarket wiring into the terminal originally designed for fuse and relays only. The electrical system and wiring of the vehicle interior may be damaged or burned due to contact failure.
- If you directly connect the wire on the taillight or replace the bulb which is over the regulated capacity to install trailers etc., the inner junction block can get burned.
- Do not use a screwdriver or any other metal object to remove fuses because it may cause a short circuit and damage the system.

* NOTICE

- When replacing fuse, turn the ignition "OFF" and turn off switches of all electrical devices then remove battery (-) terminal.
- The actual fuse/relay panel label may differ from equipped items.
- **Window tinting precaution**
Window tint (especially metallic film) might cause communication disorder or poor radio reception, and malfunction of the automatic lighting system due to excessive change of illumination inside the vehicle. The solution used might also flow into electric, electronic devices causing disorder and failure.

Replacing inner panel fuse

Operation

1. Turn the vehicle and all other switches off.
2. Open the fuse panel cover.



3. Pull the suspected fuse straight out. Use the removal tool (1) provided in the main fuse box in the engine compartment.



4. Check the removed fuse; replace it if it is blown. Spare fuses are provided in the instrument panel fuse panel (or in the engine compartment fuse panel).
5. Push in a new fuse of the same rating, and make sure it fits tightly in the clips.

* INFORMATION

If the headlights or taillights, stoplights, day time running lights (DRL) do not work and the fuses are OK, consult a professional workshop. Kia recommends to consult an authorized Kia dealer/service partner.

Replacing engine compartment fuse

Replacing blade/cartridge type fuses



Operation

1. Turn the vehicle and all other switches off.
2. Remove the fuse panel cover by pressing the tab and pulling the cover up.

When the blade type fuse is disconnected, remove it by using the clip (1) designed for changing fuses located in the engine room fuse box. Upon removal, securely insert reserve fuse of equal quantity.



3. Check the removed fuse; replace it if it is blown. To remove or insert the fuse, use the fuse puller in the engine compartment fuse panel.
4. Push in a new fuse of the same rating, and make sure it fits tightly in the clips. If it fits loosely, consult a professional workshop. Kia recommends to consult an authorized Kia dealer/service partner.

Replacing main/multi fuses



Operation

1. Turn off the vehicle.
2. Remove the fuse panel cover by pressing the tab and pulling the cover up.
3. Disconnect the negative battery cable.
4. Remove the nuts shown in the picture above.
5. Replace the fuse with a new one of the same rating.
6. Reinstall in the reverse order of removal.
7. If it fits loosely, consult a professional workshop. Kia recommends to consult an authorized Kia dealer/service partner.

Replacing relay



1. Turn the vehicle and all other switches off.
2. Remove the fuse panel cover by pressing the tab and pulling the cover up.
3. Replace the relay with a new one of the same rating.
4. Reinstall in the reverse order of removal.

5. If it fits loosely, consult a professional workshop. Kia recommends to consult an authorized Kia dealer/service partner.

⚠ CAUTION

- After checking the fuse panel in the engine compartment, securely install the fuse panel cover through the audible clicking sound. If not, electrical failures may occur from water contact.
- Visually inspect the battery cap for secure closing. If the battery cap is not securely latched, the electrical system may be damaged to due influx of moisture into the system.

*** NOTICE**

- The electronic system may not function correctly even when the engine room and internal fuse box's individual fuses are not disconnected. In such case the cause of the problem may be disconnection of the main fuse (BFT type), which is located inside the positive battery terminal (+) cap. Since the main fuse is designed more intricately than other parts, visit a professional workshop. Kia recommends to visit the nearest authorized Kia dealer/service partner.
- If the multi fuse is blown, consult a professional workshop. Kia recommends to consult an authorized Kia dealer/service partner.

Fuse/relay panel description

Inside the fuse/relay panel covers, you can find the fuse/relay label describing fuse/relay name and capacity.

*** NOTICE**

Not all fuse panel descriptions in this manual may be applicable to your vehicle. It is accurate at the time of printing. When you inspect the fuse panel in your vehicle, refer to the fuse panel label.

Driver's side fuse panel









For HEV vehicle







USE THE DESIGNATED FUSE ONLY
 USE SOLO LOS FUSIBLES ESPECIFICADOS

استخدم الفيوز ذو القياس المناسب

P/NO: 91990-ATO40

OSG2PH072006L

Fuse Name	Symbol	Fuse rating	Circuit Protected
T/GATE		15 A	Tail Gate Relay
DR LOCK		20 A	Center Door Lock/Unlock Relay, Dead Lock Relay
MULTI MEDIA	MULTI MEDIA	25 A	Audio/Navigation Head Unit
E-CALL	E-CALL	10 A	E-Call Unit
MEMORY	MEMORY	10 A	Instrument Cluster, Head Up Display, Mood lamp, Air Conditioner Control Module
START		7.5 A	Burglar Alarm Relay, HPCU, IBU
E-SHIFTER3	³ 	10 A	SCU, Electronic Shift Dial
MODULE6	⁶ MODULE	7.5 A	IBU (INTEGRATED BODY CONTROL UNIT)
MODULE3	³ MODULE	7.5 A	Overhead Console, Multifunction Switch, Stop Lamp Switch
A/BAG1	¹ 	15 A	SRS (Supplemental Restraint System) Control Module
WASHER		15 A	Washer control lever
MODULE1	¹ MODULE	10 A	KEY INTERLOCK, AIR CONDITIONER CONTROL MODULE, CHARGING LAMP (THE PLUG-IN HYBRID VEHICLE), HAZARD SWITCH, RAIN SENSOR, STEERING WHEEL REMOTE CONTROL
IBU1	¹ IBU	10 A	IBU(INTEGRATED BODY CONTROL UNIT), SPORT MODE SWITCH
MODULE2	² MODULE	10 A	IBU, ADAS PARKING ECU, E-CALL, AUDIO/ NAVIGATION HEAD UNIT, Engine Room Junction Block (P/OUTLET Relay)
A/BAG IND	^{IND} 	7.5 A	INSTRUMENT CLUSTER(SRS CONTROL MODULE)
IBU2	² IBU	7.5 A	IBU (Integrated Body Control Unit)
MODULE4	⁴ MODULE	10 A	IBU, ADAS PARKING ECU, VESS UNIT, FRONT VIEW CAMERA, CRASH PAD SWITCH, CENTER CONSOL, REAR CORNER RADAR
A/CON	A/C	7.5 A	AIR CONDITIONER CONTROL MODULE, Engine Room Junction Block (BLOWER,PTC RELAY), A/C COMPRESSOR
A/BAG2	² 	10 A	SRS (Supplemental Restraint System) Control Module
CLUSTER	CLUSTER	7.5 A	INSTRUMENT CLUSTER, HEAD UP DISPLAY
MODULE5	⁵ MODULE	10 A	HEAD LAMP LEVELING DEVICE, AUDIO/ NAVIGATION HEAD UNIT, WIRELESS SMART PHONE CHARGING SYSTEM, E-CALL UNIT, AIR CONDITIONER CONTROL MODULE, OVERHEAD CONSOLE LAMP, ELECTRIC CHROMIC MIRROR, AMP(AMPLIFIER),SEAT WARMER CONTROL MODULE
MODULE7	⁷ MODULE	7.5 A	ADAS PARKING ECU, AC INVERTER, COOLING FAN MOTOR, SEAT WARMER CONTROL MODULE
BRAKE SWITCH	BRAKE SWITCH	10 A	IBU (Integrated Body Control Unit), Stop Lamp Switch
MDPS2	² 	7.5 A	MDPS (Motor Driven Power Steering) Unit

Fuse Name	Symbol	Fuse rating	Circuit Protected
SUNROOF		20 A	SUNROOF UNIT
HEATED MIRROR		10 A	Outside Heated Mirror
IG3 2	² IG3	10 A	BATTERY MANAGEMENT SYSTEM
IG3 3	³ IG3	10 A	ON BOARD CHARGER UNIT, HPCU, Engine Room Junction Block (BATTERY C/FAN Relay), A/C COMPRESSOR
IG3 4	⁴ IG3	10 A	AUDIO/ NAVIGATION HEAD UNIT, CHARGING IND, INSTRUMENT CLUSTER, AIR CONDITIONER CONTROL MODULE, HV PTC HEATER UNIT
CHILD LOCK		15 A	Electronic child safety lock system
FRT WIPER2	² 	10 A	Front Wiper Motor
FCA		10 A	Front Radar
RR WIPER		15 A	Rear Wiper Relay, Rear Wiper Motor
E-SHIFTER4	⁴ E-SHIFTER	10 A	SCU, Electronic Shift Dial
BMS	BATTERY MANAGEMENT	10 A	Battery Management System
USB CHARGER	USB CHARGER	10 A	USB CHARGER (FRONT TRAY/ SEAT DRV/ PASS)
IG1 2	² IG1	25 A	Engine Room Junction Block (PCB BLOCK FUSE - IEB4, ECU3, DCT3, EWP3)
FUEL FILLER DOOR		10 A	Opening the fuel filler door
E-SHIFTER2	² E-SHIFTER	10 A	SCU, Electronic Shift Dial





Engine compartment fuse panel

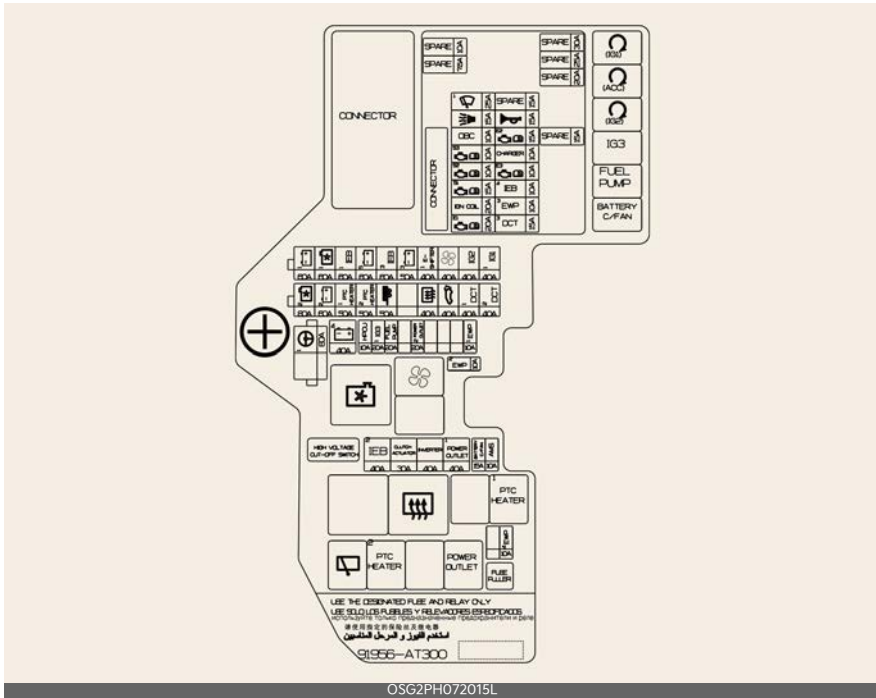





OSG2PH072023L

















Engine Room Junction Block

Fuse Name		Symbol	Fuse rating	Circuit Protected
MULTI FUSE	C/FAN2	 2	80 A	Cooling Fan Motor
MULTI FUSE	PTC HEATER1	 PTC HEATER	50 A	PTC HEATER #1 RELAY
	B+2	 2	60 A	ICU JUNCTION BLOCK (IPS)
MULTI FUSE	MDPS 1	 1	80 A	MDPS (Motor Driven Power Steering) Unit
	REAR HEATED	 1	40 A	Engine Room Junction Block (Rear Heated Relay)

Fuse Name		Symbol	Fuse rating	Circuit Protected
MULTI FUSE	POWER TAIL-GATE		40 A	Power Tail Gate Unit
	E-SHIFTER1	¹ 	40 A	SCU
MULTI FUSE	B+3	³ 	50 A	ICU JUNCTION BLOCK (FUSE - CHILD LOCK, E-SHIFTER3, P/WDW LH, P/WDW RH, T/GATE OPEN, AMP, P/SEAT DRV, P/SEAT PASS, S/HEATER FRT, S/HEATER RR), EWP2
MULTI FUSE	TRAILER	² 	50 A	Trailer Module
	FUEL PUMP		20 A	Engine Room Junction Block (Fuel Pump Relay)
MULTI FUSE	BLOWER		40 A	Engine Room Junction Block (Blower Relay)
MULTI FUSE	B+4	⁴ 	40 A	ICU JUNCTION BLOCK (FUSE - MULTIMEDIA, E-CALL, A/BAG2, BRAKE SWITCH, MODULE1, FUEL LID, IBU1, SUNROOF, BATTERY MANAGEMENT, DOOR LOCK)
	B+1	¹ 	60 A	ICU JUNCTION BLOCK (IPS)
	AMS	AMS	10 A	BATTERY SENSOR(PHEV)
FUSE	IEB2	² IEB	40 A	Integrated Electric Brake Unit
	IEB3	³ IEB	60 A	Integrated Electric Brake Unit
MULTI FUSE	IEB1	¹ IEB	60 A	Integrated Electric Brake Unit
	IG3 1	IG3	20 A	IGNITION3 RELAY
FUSE	BATTERY C/ FAN	BATTERY C/FAN	15 A	Battery Cooling Fan
	HPCU	HPCU	10 A	Hybrid Power Control Unit
	EWP2	² EWP	10 A	BATTERY ELECTRONIC WATER PUMP
FUSE	POWER OUT-LET2	² POWER OUTLET	20 A	Front Power Outlet
	EWP1	¹ EWP	10 A	Engine Electronic Water Pump
MULTI FUSE	PTC HEATER2	² PTC HEATER	50 A	PTC HEATER #2 RELAY
	DCT1	¹ DCT	40 A	DUAL CLUTCH TRANSMISSION
	DCT2	² DCT	40 A	DUAL CLUTCH TRANSMISSION
	C/FAN1	¹ 	60 A	COOLING FAN MOTOR
	B+5	⁵ 	60 A	Engine Room PCB Junction Block
	IG2	IG2	40 A	ICU JUNCTION BLOCK (FUSE - WASHER, A/C, MODULE6, MODULE7, WIPER RR)
	IG1 1	¹ IG1	40 A	ICU JUNCTION BLOCK (FUSE -MODULE2, USB CHARGER, A/BAG1, IBU2, MDPS2, CLUSTER, MODULE3, A/BAG IND, MODULE4, MODULE5, E-SHIFTER2, FCA, ING1 2)













Fuse Name		Symbol	Fuse rating	Circuit Protected
FUSE	CLUTCH ACTRUATOR		30 A	ENGINE CLUTCH ACTUATOR (HPCU)
	INVERTER		40 A	AC INVERTER
	POWER OUT-LET1	¹ 	40 A	Front Power Outlet
	EWP4	⁴ 	10 A	Engine Electronic Water Pump

PCB Block

Fuse Name	Symbol	Fuse rating	Circuit Protected
SENSOR1	^{S1} 	15 A	Oxygen Sensor (Up/Down)
ECU2	^{E2} 	15 A	ECM (ENGINE CONTROL MODULE)
SENSOR3	^{S3} 	10 A	FUEL PUMP RELAY
SENSOR2	^{S2} 	10 A	OIL CONTROL VALVE, PURGE CONTROL SOLENOID VALVE, VARIABLE OIL PUMP VALVE CONTROL, COOLING FAN MOTOR RELAY,FUEL TANK ISOLATION VALVE(PHEV)
FRT WIPER1	¹ 	25 A	Front Wiper Motor
ECU 3	^{E3} 	10 A	ECM (ENGINE CONTROL MODULE)
IEB 4	⁴ 	10 A	Integrated Electric Brake Unit
EWP 3	¹ 	10 A	Engine Electronic Water Pump
OBC		10 A	ON BOARD CHARGER UNIT(PHEV)
ECU1	^{E1} 	20 A	ECM (ENGINE CONTROL MODULE)
B/ALARM HORN		15 A	BURGLAR ALARM HORN RELAY
IGN COIL		20 A	Ignition Coil #1/#2/#3/#4
CHARGER		10 A	CHARGER LOCK/UNLOCK RELAY(PHEV)
DCT3	³ 	15 A	DUAL CLUTCH TRANSMISSION

Relay

Refer to the following table for the relay type.

Relay Name	Symbol	TYPE
Fuel Pump Relay		MICRO
PTC Heater1 Relay		MICRO
Blower Relay		MICRO
Rear Heated Relay		MINI
IG3 Relay		MICRO
Battery Cooling Fan Relay (HEV)		MICRO
PDM (IG1) RELAY		MICRO
PDM (ACC) RELAY		MICRO
PDM (IG2) RELAY		MICRO
COOLING FAN MOTOR RELAY		MICRO
PTC HEATER2 RELAY		MICRO
POWER OUTLET		MICRO

Engine compartment fuse panel (Battery terminal cover) (For Plug-in Hybrid)

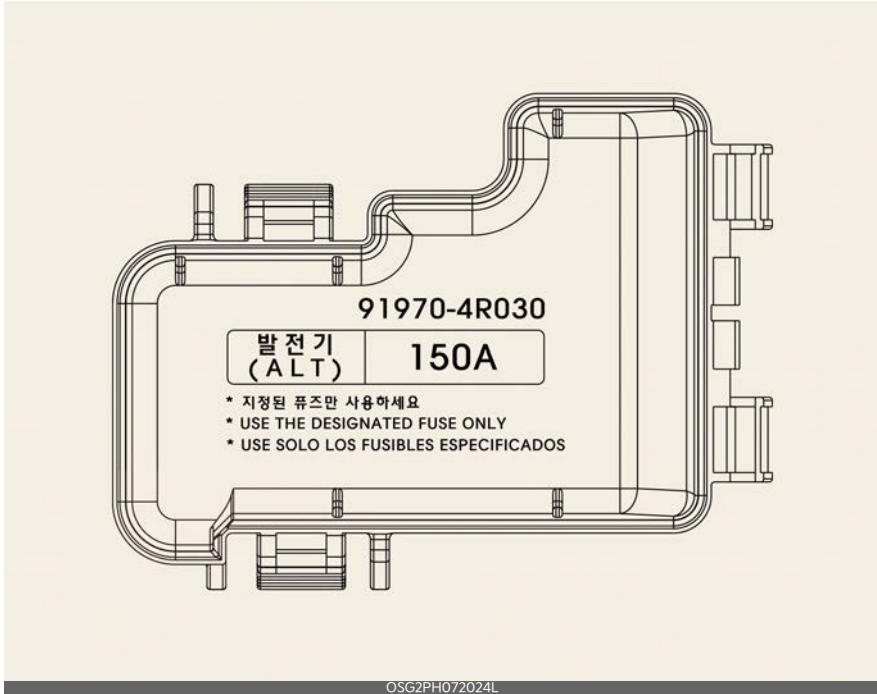

Light bulbs

Bulb replacement precautions

Turn off the engine at a safe place, firmly apply the parking brake and take out the battery's negative (-) terminal. Use only the bulbs of the specified wattage.

Lamp part malfunction due to net-work failure

The headlamp, taillight, and fog light may lit up when the head lamp switch is turned ON, and not light up when the taillight or for light switch is turned ON. This may be cause by network failure or vehicle electrical control system malfunction. If there is a problem, have the system serviced by a professional workshop. Kia recommends to visit an authorized Kia dealer/service partner.

Lamp part malfunction due to electrical control system stabilization

A normally functioning lamp may flicker momentarily. This momentary occurrence is due to stabilization unction of the vehicle's electrical on control system. If the lamp soon returns to normal, the vehicle does not require service.

However, if the lamp goes out after the momentary flickering, or the flickering continues, have the system serviced by a professional workshop. Kia recommends to visit an authorized Kia dealer/service partner.

WARNING

- Prior to working on the light, firmly apply the parking brake, ensure that the ignition switch is turned to the LOCK position and turn off the lights

to avoid sudden movement of the vehicle and burning your fingers or receiving an electric shock.

- Be sure to replace the burned out bulb with one of the same wattage rating. Otherwise, it may cause extensive wiring damage and possible fire.

CAUTION

- If you don't have necessary tools, the correct bulbs and the expertise, consult a professional workshop. Kia recommends to consult an authorized Kia dealer/service partner.
- In many cases, it is difficult to replace vehicle light bulbs because other parts of the vehicle must be removed before you can get to the bulb. This is especially true if you have to remove the headlight assembly to get to the bulb(s). Removing/installing the headlight assembly can result in damage to the vehicle. Use only Kia Genuine Parts or those of an equivalent standard part. If not, it may lead to blowing a fuse or other wiring damages.
- If unauthentic parts or substandard lights are used when changing lights, it may lead to fuse disconnection and malfunction, and other wiring damages.
- Do not install extra lamps or LED to the vehicle. If supplementary lights are installed, it may lead to lamp malfunction and flickering of the lights. In addition, the fuse box and other wiring may be damaged.

NOTICE

- If the light bulb or lamp connector is removed from an operating lamp activated by electricity, the fuse box's

electronic device may scan it as a malfunction. Therefore, a lamp malfunction history may be recorded in Diagnostic Trouble Code (DTC) in the fuse box.

- It is normal for an operating lamp may blink temporarily. Since this occurrence is due stabilization function of the vehicle's electronic control device, if the lamp lights up normally after temporary blinking, there is no problem in the vehicle.

However, if the lamp continues to blink several times or turn off completely, there may be an error in the vehicle's electronic control device. In this case, have the vehicle checked by a professional workshop immediately. Kia recommends to visit an authorized Kia dealer/service partner.

- After an accident or after the headlight assembly is reinstalled, have the headlight aiming adjusted by a professional workshop. Kia recommends to visit an authorized Kia dealer/service partner.
- After driving in heavy rain or washing, headlamp and taillamp lenses could appear frosty. This condition is caused by the temperature difference between the lamp inside and outside. This is similar to the condensation on your windows inside your vehicle during the rain and doesn't indicate a problem with your vehicle. If the water leaks into the lamp bulb circuitry, have the vehicle checked by a professional workshop. Kia recommends to visit an authorized Kia dealer/service partner.

* NOTICE

Traffic Change (For Europe)

The low beam light distribution is asymmetric. If you go abroad to a country with opposite traffic direction, this asymmetric part will dazzle oncoming car driver. To prevent dazzle, ECE regulation demand several technical solutions (ex. automatic change system, adhesive sheet, down aiming). This headlamps are designed not to dazzle opposite drivers. So, you need not change your headlamps in a country with opposite traffic direction.

Light position (Front)

Head lamp - Type A



Head lamp - Type B



Front fog lamp



- 1 Headlamp (Low) (LED type)
- 2 Headlamp (Low/High) (Bulb type)

- 3 Headlamp (Low/High) (LED type)
- 4 Front turn signal lamp (Bulb type)
- 5 Day time running lamp/Position lamp (LED type)
- 6 Day time running lamp/Position lamp/ Front turn signal lamp (LED type)
- 7 Front fog lamp (LED type)

- 6 High mounted stop lamp (LED type)
- 7 License plate lamp (Bulb type)
- 8 Rear fog lamp (LED type, Left-hand drive)
Backup lamp (Bulb type, Right-hand drive)
- 9 Rear fog lamp (LED type, Left-hand drive)
Backup lamp (LED type, Right-hand drive)

Light position (Rear)

Rear combination lamp - Type A



OSG2PH072008L

Rear combination lamp - Type B



OSG2PH072009L



OSG2PH071024

- 1 Rear turn signal lamp (Bulb type)
- 2 Backup lamp (Bulb type, Left-hand drive)
Rear fog lamp (LED type, Right-hand drive)
- 3 Rear turn signal lamp (LED type)
- 4 Backup lamp (LED type, Left-hand drive)
Rear fog lamp (LED type, Right-hand drive)
- 5 Tail lamp (LED type)

Light position (Side) (if equipped)



OSG2PH072025L



OSG2PH072029L

- 1 Side repeater lamp (Bulb type)
- 2 Side repeater lamp (LED type)

Replacing lights (LED type)

If the LED lamp does not operate, have your vehicle checked by a professional workshop. Kia recommends to visit an authorized Kia dealer/service partner. The LED lamp cannot be replaced as a single unit because it is an integrated unit. The LED lamp has to be replaced with the unit.

A skilled technician should check or repair the LED lamp, for it may damage related parts of the vehicle.

Replacing headlamp (Low beam/ High beam) (Bulb type)

Operation

1. Before turning off the vehicle, operate the steering wheel in the opposite direction of the lamp to be replaced to steer the tires toward the inside of the vehicle body.
 - When replacing the right headlamp: operate to the left
 - When replacing the left headlamp: operate to the right
2. Turn off vehicle and disconnect the negative terminal from the battery.
3. Remove the wheel guard fasteners using a tool and then remove the wheel guard.



4. Remove the socket from the assembly (1) by turning the socket counter-clockwise until the tabs on the socket align with the slots on the assembly



5. Remove the bulb from the socket by pressing it in and rotating it counter-clockwise until the tabs on the bulb align with the slots in the socket. Pull the bulb out of the socket.

6. Insert a new bulb by inserting it into the socket and rotating it until it locks into place
7. Install the socket in the assembly by aligning the tabs on the socket with the slots in the assembly. Push the socket into the assembly and turn the socket clockwise
8. Connect the negative terminal from the battery.

Replacing front turn signal lamp (Bulb type)



Operation

1. Disconnect the negative terminal from the battery.
2. Remove the socket from the assembly (1) by turning the socket counter-clockwise until the tabs on the socket align with the slots on the assembly.
3. Remove the bulb from the socket by pressing it in and rotating it counter-clockwise until the tabs on the bulb align with the slots in the socket. Pull the bulb out of the socket.
4. Insert a new bulb by inserting it into the socket and rotating it until it locks into place.
5. Install the socket in the assembly by aligning the tabs on the socket with the slots in the assembly. Push the socket into the assembly and turn the socket clockwise.
6. Connect the negative terminal from the battery.

Replacing rear turn signal lamp, backup lamp (Bulb type)

Operation

1. Open the tailgate.
2. Open the service cover.
3. Loosen the light assembly retaining screws with a cross-tip screw driver.
4. Remove the rear combination lamp assembly from the body of the vehicle.
5. Disconnect the rear combination lamp connector.
6. Remove the socket from the assembly by turning the socket counterclockwise until the tabs on the socket align with the slots on the assembly.



- 1) Rear turn signal lamp bulb
- 2) Backup lamp

7. Remove the bulb from the socket by pressing it in and rotating it counterclockwise until the tabs on the bulb align with the slots in the socket. Pull the bulb out of the socket.
8. Insert a new bulb by inserting it into the socket and rotating it until it locks into place.
9. Install the socket in the assembly by aligning the tabs on the socket with the slots in the assembly. Push the socket into the assembly and turn the socket clockwise.
10. Install the rear combination lamp assembly to the body of the vehicle.
11. Install the service cover.

Replacing side repeater lamp (Bulb type)



Operation

1. Turn off vehicle and disconnect the negative terminal from the battery.
2. Using a screwdriver, gently pry the lamp assembly
3. Separate the socket and the lens parts by turning the socket counterclockwise until the tabs on the socket align with the slots on the lens part.
4. Remove the bulb by pulling it straight out.
5. Install a new bulb in the socket.
6. Install the lamp assembly.

⚠ CAUTION

Be careful not to dirty or damage the lens, lens tab, and plastic housings.

Replacing license plate lamp (Bulb type)

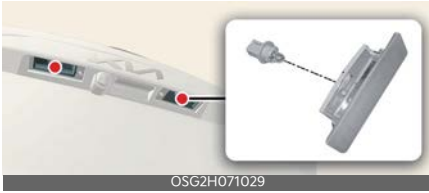

Operation

1. Turn off vehicle and disconnect the negative terminal from the battery.
2. Using a screwdriver, gently pry the lamp assembly.
3. Remove the bulb by pulling it straight out.
4. Install a new bulb in the socket.
5. Install the lamp assembly.

⚠ CAUTION

Be careful not to dirty or damage the lens, lens tab, and plastic housings.

Replacing map lamp (Bulb type)



Operation

1. Using a flat-blade screwdriver, gently pry the lens cover from lamp housing.
2. Remove the bulb by pulling it straight out.
3. Install a new bulb in the socket.
4. Align the lens cover tabs with the lamp housing notches and snap the lens into place.

⚠ WARNING

Prior to working on the Interior lamps, ensure that the "OFF" button is depressed to avoid burning your fingers or receiving an electric shock.

Replacing room lamp (Bulb type)



Operation

1. Using a flat-blade screwdriver, gently pry the lens cover from lamp housing.
2. Remove the bulb by pulling it straight out.
3. Install a new bulb in the socket.
4. Align the lens cover tabs with the lamp housing notches and snap the lens into place.

⚠ WARNING

Prior to working on the Interior lamps, ensure that the "OFF" button is depressed to avoid burning your fingers or receiving an electric shock.

Replacing vanity mirror lamp (Bulb type)



Operation

1. Using a flat-blade screwdriver, gently pry the lens cover from lamp housing.
2. Remove the bulb by pulling it straight out.
3. Install a new bulb in the socket.
4. Align the lens cover tabs with the lamp housing notches and snap the lens into place.

⚠ WARNING

Prior to working on the Interior lamps, ensure that the "OFF" button is depressed to avoid burning your fingers or receiving an electric shock.

Replacing glove box lamp (Bulb type)

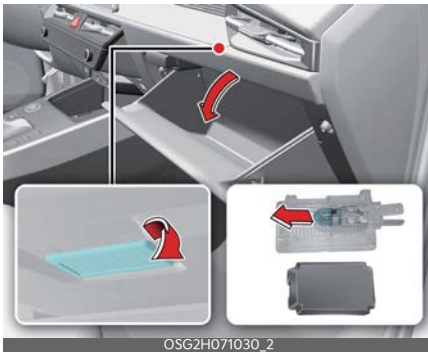

Operation

1. Using a flat-blade screwdriver, gently pry the lamp assembly from interior.
2. Remove the cover from the lamp assembly.
3. Remove the bulb by pulling it straight out.
4. Install a new bulb in the socket.
5. Install the cover to the lamp assembly.
6. Install the lamp assembly to interior.

⚠ WARNING

Prior to working on the Interior lamps, ensure that the "OFF" button is depressed to avoid burning your fingers or receiving an electric shock.

Replacing luggage lamp (Bulb type)



Operation

1. Using a flat-blade screwdriver, gently pry the lens cover from lamp housing.
2. Remove the bulb by pulling it straight out.
3. Install a new bulb in the socket.
4. Align the lens cover tabs with the lamp housing notches and snap the lens into place.

⚠ WARNING

Prior to working on the Interior lamps, ensure that the "OFF" button is depressed to avoid burning your fingers or receiving an electric shock.

Headlamp and front fog lamp aiming (for Europe)

Headlamp aiming

Type A

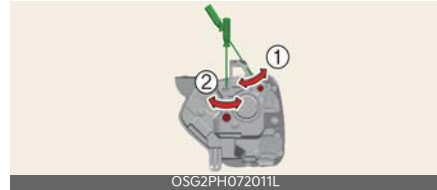

Type B

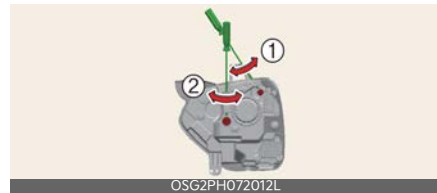

Operation

- Inflate the tires to the specified pressure and remove any loads from the vehicle except the driver, spare tire, and tools.
- The vehicle should be placed on a flat floor.
- Draw vertical lines (Vertical lines passing through respective head lamp centers) and a horizontal line (Horizontal line passing through center of head lamps) on the screen.
- With the head lamp and battery in normal condition, aim the head lamps so the brightest portion falls on the horizontal and vertical lines.
- To aim the low beam left or right, turn the screwdriver (1) clockwise or counterclockwise. To aim the low beam up or down, turn the screwdriver (2) clockwise or counterclockwise.

Front fog lamp aiming (if equipped)



The front fog lamp can be aimed in the same manner as the head lamps. With the front fog lamps and battery in normal condition, aim the front fog lamps.

Operation

- Turn the screwdriver clockwise or counterclockwise to aim the front fog lamp up or down.

Aiming point

Type A



OSG2PH072041L

Type B



OSG2PH072016L

* A: Screen

Vehicle condition		Head lamp				Front fog lamp (LED type) (if equipped)	
		Ground Height		Distance between lamps		Ground Height	Distance between lamps
		Low/High beam		Low/High beam			
		H1	H2	W1	W2	H3	W3
without driver [mm (in)]	Type A	727.4 (28.6)		1,470.4 (57.9)		354.8 (14.0)	1,060 (41.7)
	Type B	750.0 (29.5)	681.1 (26.8)	1,479.8 (58.3)	1,478.5 (58.2)		
with driver [mm (in)]	Type A	717.4 (28.2)		1,470.4 (57.9)		344.8 (13.6)	1,060 (41.7)
	Type B	740.0 (29.1)	671.1 (26.4)	1,479.8 (58.3)	1,478.5 (58.2)		

Head lamp low beam (LHD Vehicle)

Based on 10m screen

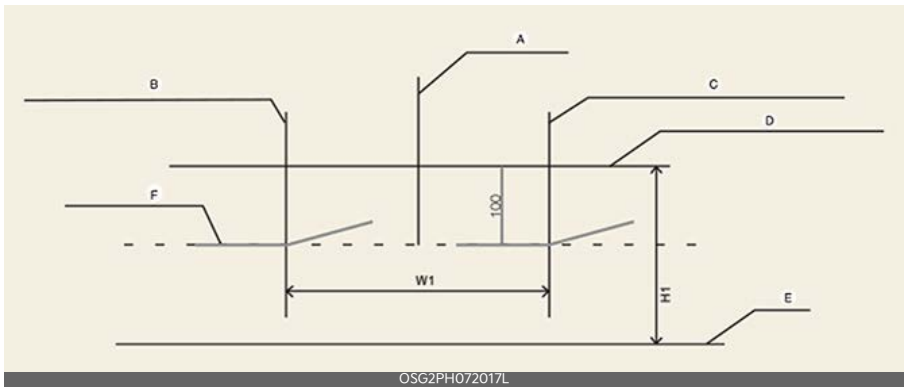

- A: Vehicle axis
- B: Vertical line of the left head lamp bulb center
- C: Vertical line of the right head lamp bulb center
- D: Horizontal line of head lamp bulb center
- E: Ground
- F: Cut-Off line

Operation

1. Turn the low beam on without driver aboard.
2. The cut-off line should be projected in the cut-off line shown in the picture.
3. When aiming the low beam, vertical aiming should be adjusted after adjusting the horizontal aiming.
4. If head lamp leveling device is equipped, adjust the head lamp leveling device switch with 0 positions.

Head lamp low beam (RHD Vehicle)

Based on 10m screen

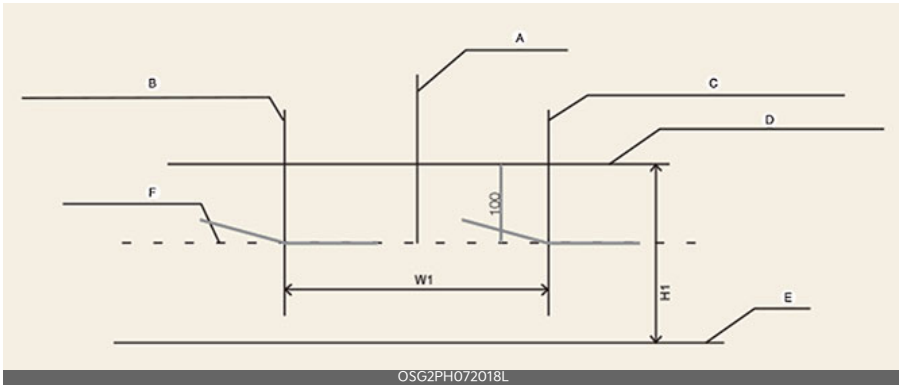

OSG2PH072018L

- A: Vehicle axis
- B: Vertical line of the left head lamp bulb center
- C: Vertical line of the right head lamp bulb center
- D: Horizontal line of head lamp bulb center
- E: Ground
- F: Cut-Off line

Operation

1. Turn the low beam on without driver aboard.
2. The cut-off line should be projected in the cut-off line shown in the picture.
3. When aiming the low beam, vertical aiming should be adjusted after adjusting the horizontal aiming.
4. If head lamp leveling device is equipped, adjust the head lamp leveling device switch with 0 positions.

Front fog lamp (if equipped)

Based on 10m screen

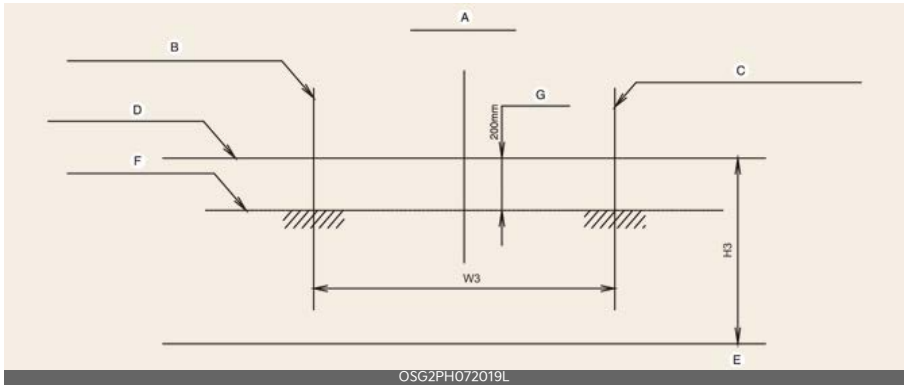

- A: Vehicle axis
- B: Vertical line of the left fog lamp bulb center
- C: Vertical line of the right fog lamp bulb center
- D: Horizontal line of fog lamp bulb center
- E: Ground
- F: Cut-Off line
- G: Upper limit

Operation

1. Turn the front fog lamp on without the driver aboard.
2. The cut-off line should be projected in the allowable range (shaded region).

Appearance care

Exterior care

Exterior general caution

It is very important to follow the label directions when using any chemical cleaner or polish. Read all warning and caution statements that appear on the label.

* NOTICE

If you park the vehicle around a stainless signboard or windshield building etc., the plastic exterior trim (bumper, spoiler, garnish, lamp, outside mirror etc.) may be damaged by reflected sunlight from the external structure. To avoid damaging the plastic exterior trim, park the vehicle away from the areas where the reflected light may occur or use a vehicle cover. (Depending on the vehicle, the type of exterior trim applied such as spoiler may differ.)

Finish maintenance

Washing

To help protect your vehicle's finish from rust and deterioration, wash it thoroughly and frequently at least once a month with lukewarm or cold water.

If you use your vehicle for off-road driving, you should wash it after each off-road trip. Pay special attention to the removal of any accumulation of salt, dirt, mud, and other foreign materials. Make sure the drain holes in the lower edges of the doors and rocker panels are kept clear and clean. Insects, tar, tree sap, bird droppings, industrial pollution and

similar deposits can damage your vehicle's finish if not removed immediately. Even prompt washing with plain water may not completely remove all these deposits. A mild soap, safe for use on painted surfaces, may be used. After washing, rinse the vehicle thoroughly with lukewarm or cold water. Do not allow soap to dry on the finish.

⚠ WARNING

After washing the vehicle, test the brakes while driving slowly to see if they have been affected by water. If braking performance is impaired, dry the brakes by applying them lightly while maintaining a slow forward speed.

⚠ CAUTION

- Do not use strong soap, chemical detergents or hot water, and do not wash the vehicle in direct sunlight or when the body of the vehicle is warm.
- Be careful when washing the side windows of your vehicle. Especially, with high-pressure water, water may leak through the windows and wet the interior.
- To prevent damage to the plastic parts and lamps, do not clean with chemical solvents or strong detergents.

High-pressure washing



- When using high-pressure washers, make sure to maintain sufficient distance from the vehicle. Insufficient clearance or excessive pressure can lead to component damage or water penetration.
- Do not spray the camera, sensors or its surrounding area directly with a high pressure washer. Shock applied from high pressure water may cause the device to not operate normally.
- Do not bring the nozzle tip close to boots (rubber or plastic covers) or connectors as they may be damaged if they come into contact with high pressure water.

⚠ CAUTION

- Water washing in the engine compartment including high pressure water washing may cause the failure of electrical circuits located in the engine compartment.
- Never allow water or other liquids to come in contact with electrical/electronic components inside the vehicle as this may damage them.

* NOTICE

Finish damage repair

- Automatic car wash which uses rotating brushes should not be used as this can damage the surface of your vehicle. A steam cleaner which washes the vehicle surface at high temperature

may result the oil to adhere and leave stains that is difficult to remove.

- Use a soft cloth (e.g. microfiber towel or sponge) when washing your vehicle and dry with a microfiber towel. When you hand wash your vehicle, you should not use a cleaner that finishes with wax. If the vehicle surface is too dirty (sand, dirt, dust, contaminant, etc.), clean the surface with water before washing the car.

Waxing

Wax the vehicle when water will no longer bead on the paint.

Always wash and dry the vehicle before waxing. Use a good quality liquid or paste wax, and follow the manufacturer's instructions. Wax all metal trim to protect it and to maintain its luster.

Removing oil, tar, and similar materials with a spot remover will usually strip the wax from the finish. Be sure to re-wax these areas even if the rest of the vehicle does not yet need waxing. Do not apply wax on embossed unpainted unit, as it may tarnish the unit.

⚠ CAUTION

- Wiping dust or dirt off the body with a dry cloth will scratch the finish.
- Do not use steel wool, abrasive cleaners, acid detergents or strong detergents containing high alkaline or caustic agents on chrome-plated or anodized aluminum parts. This may result in damage to the protective coating and cause discoloration or paint deterioration.

Finish damage repair

Deep scratches or stone chips in the painted surface must be repaired promptly. Exposed metal will quickly rust and may develop into a major repair expense.

* NOTICE

If your vehicle is damaged and requires any metal repair or replacement, be sure the body shop applies anti-corrosion materials to the parts repaired or replaced.

Bright-metal maintenance

- To remove road tar and insects, use a tar remover, not a scraper or other sharp object.
- To protect the surfaces of bright metal parts from corrosion, apply a coating of wax or chrome preservative and rub to a high luster.
- During winter weather or in coastal areas, cover the bright metal parts with a heavier coating of wax or preservative. If necessary, coat the parts with non-corrosive petroleum jelly or other protective compound.

Underbody maintenance

Corrosive materials used for ice and snow removal and dust control may collect on the underbody. If these materials are not removed, accelerated rusting can occur on underbody parts such as the fuel lines, frame, floor pan and exhaust system, even though they have been treated with rust protection.

Thoroughly flush the vehicle underbody and wheel openings with lukewarm or cold water once a month, after off-road driving and at the end of each winter.

Pay special attention to these areas because it is difficult to see all the mud and dirt. It will do more harm than good to wet down the road grime without removing it. The lower edges of the doors, rocker panels, and frame members have drain holes that should not clog with dirt; trapped water in these areas can cause rusting.

⚠ WARNING

After washing the vehicle, test the brakes while driving slowly to see if they have been affected by water. If braking performance is impaired, dry the brakes by applying them lightly while maintaining a slow forward speed.

Aluminum wheel maintenance

The aluminum wheels are coated with a clear protective finish.

- Do not use any abrasive cleaner, polishing compound, solvent, or wire brushes on aluminum wheels. They may scratch or damage the finish.
- Clean the wheel when it has cooled.
- Use only a mild soap or neutral detergent, and rinse thoroughly with water. Also, be sure to clean the wheels after driving on salted roads. This helps prevent corrosion.
- Avoid washing the wheels with high-speed car wash brushes.
- Do not use any alkaline or acid detergent. It may damage and corrode the aluminum wheels coated with a clear protective finish.

Corrosion protection

Protecting your vehicle from corrosion

By using the most advanced design and construction practices to combat corrosion, we produce vehicles of the highest quality. However, this is only part of the job. To achieve the longterm corrosion resistance your vehicle can deliver, the owner's cooperation and assistance is also required.

Common causes of corrosion

The most common causes of corrosion on your vehicle are:

- Road salt, dirt and moisture that is allowed to accumulate underneath the vehicle.
- Removal of paint or protective coatings by stones, gravel, abrasion or minor scrapes and dents which leave unprotected metal exposed to corrosion.

High-corrosion areas

If you live in an area where your vehicle is regularly exposed to corrosive materials, corrosion protection is particularly important. Some of the common causes of accelerated corrosion are road salts, dust control chemicals, ocean air and industrial pollution.

Moisture breeds corrosion

Moisture creates the conditions in which corrosion is most likely to occur. For example, corrosion is accelerated by high humidity, particularly when temperatures are just above freezing. In such conditions, the corrosive material is kept in contact with the vehicle's surface by moisture that evaporate slowly. Mud

is particularly corrosive because it dries slowly and holds moisture in contact with the vehicle. Although the mud appears to be dry, it can still retain moisture and promote corrosion. High temperatures can also accelerate corrosion of parts that are not properly ventilated so the moisture can be dispersed.

For all these reasons, it is particularly important to keep your vehicle clean and free of mud or accumulations of other materials. This applies not only to the visible surfaces but particularly to the underside of the vehicle.

To help prevent corrosion

You can help prevent corrosion from getting started by observing the following:

Keep your vehicle clean

The best way to prevent corrosion is to keep your vehicle clean and free of corrosive materials. Attention to the underside of the vehicle is particularly important.

- If you live in a high-corrosion area - where road salts are used, near the ocean, areas with industrial pollution, acid rain, etc., you should take extra care to prevent corrosion. In winter, hose off the underside of your vehicle at least once a month and be sure to clean the underside thoroughly when winter is over.
- When cleaning underneath the vehicle, give particular attention to the components under the fenders and other areas that are hidden from view. Do a thorough job; just dampening the accumulated mud rather than washing it away will accelerate corrosion rather than prevent it. Water

under high pressure and steam are particularly effective in removing accumulated mud and corrosive materials.

- When cleaning lower door panels, rocker panels and frame members, be sure that drain holes are kept open so that moisture can escape and not be trapped inside to accelerate corrosion.

Keep your garage dry

Don't park your vehicle in a damp, poorly ventilated garage. This creates a favorable environment for corrosion. This is particularly true if you wash your vehicle in the garage or drive it into the garage when it is still wet or covered with snow, ice or mud. Even a heated garage can contribute to corrosion unless it is well ventilated so moisture is dispersed.

Keep paint and trim in good condition

Scratches or chips in the finish should be covered with "touch-up" paint as soon as possible to reduce the possibility of corrosion. If bare metal is showing through, the attention of a qualified body and paint shop is recommended.

Bird droppings: Bird droppings are highly corrosive and may damage painted surfaces in just a few hours. Always remove bird droppings as soon as possible.

Don't neglect the interior

Moisture can collect under the floor mats and carpeting and cause corrosion. Check under the mats periodically to be sure the carpeting is dry. Use particular

care if you carry fertilizers, cleaning materials or chemicals in the vehicle. These should be carried only in proper containers and any spills or leaks should be cleaned up, flushed with clean water and thoroughly dried.

Interior care

Interior general precautions

Prevent chemicals such as perfume, cosmetic oil, sun cream, hand cleaner, and air freshener from contacting the interior parts because they may cause damage or discoloration. If they do contact the interior parts, wipe them off immediately. If necessary, use a mixture of warm water and mild non-detergent cleaner (test all cleaners on a concealed area before use). Use proper car cleaner to clean interior parts.

CAUTION

- Never allow water or other liquids to come in contact with electrical/electronic components inside the vehicle as this may damage them.
- When cleaning leather products (steering wheel, seats etc.), use neutral detergents or low alcohol content solutions. If you use high alcohol content solutions or acid/alkaline detergents, the color of the leather may fade or the surface may get stripped off.

Taking care of leather seats (if equipped)

- Vacuum the seat periodically to remove dust and sand on the seat. It will prevent abrasion or damage of the leather and maintain its quality.
- Wipe the leather seat cover often with dry or soft cloth.
- Sufficient use of a leather protective may prevent abrasion of the cover and helps maintain the color. Be sure to read the instructions and consult a specialist when using leather coating or protective agents.
- Leather with bright colors (beige, cream beige) is easily contaminated and clear in appearance. Clean the seats frequently.
- Avoid wiping with wet cloth. It may cause the surface to crack.

Cleaning the leather seats (if equipped)

- Remove all contaminations instantly. Refer to instructions below for removal of each contaminant.
- Cosmetic products (sunscreen, foundation, etc.)
 - Apply cleansing cream on a cloth and wipe the contaminated point. Wipe off the cream with a wet cloth and remove water with a dry cloth.
- Beverages (coffee, soft drink, etc.)
 - Apply a small amount of neutral detergent and wipe until contaminations do not smear.
- Oil
 - Remove oil instantly with absorbable cloth and wipe with stain remover for leather only.
- Chewing gum

- Harden the gum with ice and remove gradually.

Fabric seat cover using precautions (if equipped)

Please clean the fabric seats regularly with a vacuum cleaner in consideration of fabric material characteristics. If they are heavily soiled with beverage stains, etc., use a suitable interior cleaner. To prevent damage to seat covers, wipe off the seat covers down to the seams with a large wiping motion and moderate pressure using a soft sponge or microfiber cloth.

Velcro closures on clothing or sharp objects may cause snagging or scratches on the surface of the seats. Make sure not to rub such objects against the surface.

Cleaning the upholstery and interior trim

Car interior surfaces

Remove dust and loose dirt from interior surfaces with a whisk broom or a vacuum cleaner. If necessary, clean interior surfaces with a mixture of warm water and mild non-detergent cleaner (test all cleaners on a concealed area before use).

Fabric

Remove dust and loose dirt from fabric with a whisk broom or vacuum cleaner. Clean with a mild soap solution recommended for upholstery or carpets. Remove fresh spots immediately with a fabric spot cleaner. If fresh spots do not receive immediate attention, the fabric can be stained and its color can be

affected. Also, its fire-resistant properties can be reduced if the material is not properly maintained.

⚠ CAUTION

Using anything but recommended cleaners and procedures may affect the fabric's appearance and fire-resistant properties.

Cleaning the lap/shoulder belt webbing

Clean the belt webbing with any mild soap solution recommended for cleaning upholstery or carpet. Follow the instructions provided with the soap. Do not bleach or re-dye the webbing because this may weaken it.

Cleaning the interior window glass

If the interior glass surfaces of the vehicle become fogged (that is, covered with an oily, greasy or waxy film), they should be cleaned with a glass cleaner. Follow the directions on the glass cleaner container.

⚠ CAUTION

Do not scrape or scratch the inside of the rear window. This may result in damage of the rear window defroster grid.

Emission control system (if equipped)

The emission control system of your vehicle is covered by a written limited warranty. Please see the warranty information contained in the Warranty & Maintenance book in your vehicle.

Your vehicle is equipped with an emission control system to meet all applicable emission regulations.

There are three emission control systems, as follows.

1. Crankcase emission control system
2. Evaporative emission control system
3. Exhaust emission control system

In order to assure the proper function of the emission control systems, have your vehicle inspected and maintained by a professional workshop in accordance with the maintenance schedule in this manual. Kia recommends to visit an authorized Kia dealer/service partner.

Caution for the Inspection and Maintenance Test (With Electronic Stability Control (ESC) system)

- **To prevent the vehicle from misfiring during dynamometer testing, turn the Electronic Stability Control (ESC) system off by pressing the ESC switch.**
- **After dynamometer testing is completed, turn the ESC system back on by pressing the ESC switch again.**

1. Crankcase emission control system

The positive crankcase ventilation system is employed to prevent air pollution caused by blow-by gases being emitted from the crankcase. This system supplies fresh filtered air to the crankcase through the air intake hose. Inside the crankcase, the fresh air mixes with blow-by gases, which then pass through the PCV valve into the induction system.

2. Evaporative emission control system

The Evaporative Emission Control System is designed to prevent fuel vapors from escaping into the atmosphere.

Canister

Fuel vapors generated inside the fuel tank are absorbed and stored in the onboard canister. When the engine is running, the fuel vapors absorbed in the canister are drawn into the surge tank through the purge control solenoid valve.

Purge Control Solenoid Valve (PCSV)

The purge control solenoid valve is controlled by the Engine Control Module (ECM); when the engine coolant temperature is low during idling, the PCSV closes so that evaporated fuel is not taken into the engine. After the engine warms up during ordinary driving, the PCSV opens to introduce evaporated fuel to the engine.

3. Exhaust emission control system

The Exhaust Emission Control System is a highly effective system which controls exhaust emissions while maintaining good vehicle performance.

Engine exhaust gas precautions (carbon monoxide)

- Carbon monoxide can be present with other exhaust fumes. Therefore, if you smell exhaust fumes of any kind inside your vehicle, have it inspected and repaired immediately. If you ever suspect exhaust fumes are coming into your vehicle, drive it only with all the windows fully open. Have your vehicle checked and repaired immediately.
- Do not operate the engine in confined or closed areas (such as garages) any more than what is necessary to move the vehicle in or out of the area.
- When the vehicle is stopped in an open area for more than a short time with the engine running, adjust the ventilation system (as needed) to draw outside air into the vehicle.
- Never sit in a parked or stopped vehicle for any extended time with the engine running.
- When the engine stalls or fails to start, excessive attempts to restart the engine may cause damage to the emission control system.

⚠ WARNING

Engine exhaust gases contain carbon monoxide (CO). Though colorless and odorless, it is dangerous and could be lethal if inhaled. Follow the instructions on this page to avoid CO poisoning.

Operating precautions for catalytic converters

Your vehicle is equipped with a catalytic converter emission control device.

Therefore, the following precautions must be observed:

- Make sure to refuel your vehicle according to the "Fuel requirements" on page 2-2.
- Do not operate the vehicle when there are signs of engine malfunction, such as misfire or a noticeable loss of performance.
- Do not misuse or abuse the engine. Examples of misuse are coasting with the ignition off and descending steep grades in gear with the ignition off.
- Do not operate the engine at high idle speed for extended periods (5 minutes or more).
- Do not modify or tamper with any part of the engine or emission control system. All inspections and adjustments must be made by a professional workshop. Kia recommends to visit an authorized Kia dealer/service center.
- Avoid driving with an extremely low fuel level. Running out of fuel could cause the engine to misfire, damaging the catalytic converter.

Failure to observe these precautions could result in damage to the catalytic converter and to your vehicle. Additionally, such actions could void your warranties.

WARNING

- A hot exhaust system can ignite flammable items under your vehicle. Do not park the vehicle over or near flammable objects, such as grass, vegetation, paper, leaves, etc.
- The exhaust system and catalytic system are very hot while the engine is running or immediately after the engine is turned off. Keep away from the exhaust system and catalytic, you may get burned.

Also, do not remove the heat sink around the exhaust system, do not seal the bottom of the vehicle or do not coat the vehicle for corrosion control. It may present a fire risk under certain conditions.

Gasoline particulate filter (if equipped)

The Gasoline Particulate Filter (GPF) is the system that removes the soot from the exhaust gas. Unlike a disposable air filter, the GPF system automatically burns (oxidizes) and removes the accumulated soot while driving.

However, repeated short-distance driving or long-distance driving at a low speed can stop the accumulated soot from automatically being removed by the GPF system. If the accumulated soot reaches a certain amount, the GPF warning light () will illuminate. To re-operate the GPF system, the vehicle should be driven for more than 30 minutes at a speed of 80 km/h and faster. Ensure the following conditions are met: safe road conditions, transmission 3 or above, and engine speed of 1,500-4,000 rpm. Driving at 80 km/h or faster for recommended hours will get the GPF

system back to work and stop the GPF warning light.

If the GPF warning light stays on or the warning message "check exhaust system" pops up even after driving at recommended speed and for recommended hours, visit a professional workshop and have them check the GPF system. Constant driving with the GPF warning light on can damage the GPF system and undermine fuel economy.

Procedure for entering forced engine activation mode

If the engine needs to be kept running while the vehicle is stopped to inspect emission gas or perform vehicle maintenance, follow below procedure to enter forced engine activation mode.

1. Place the shift dial in P (Park) position with the vehicle stopped. Engage the parking brake. Then, follow the steps (1) to (5).

Below steps from (1) to (5) must be completed within 60 seconds. If not, the process is reset and you must start again from step (1).

- 1) Turn the ignition switch to the ON position. Vehicles equipped with the smart key, press the ENGINE START/STOP button twice without depressing the brake pedal.
 - 2) Place the shift dial in P (Park) position and depress the accelerator pedal twice.
 - 3) Place the shift dial in N (Neutral) position and depress the accelerator pedal twice.
 - 4) Place the shift dial in P (Park) position and depress the accelerator pedal twice.
 - 5) With the brake pedal depressed, start the engine, and maintain idling state. The engine remains in idle state and the forced engine activation mode is maintained even when the gear is shifted to a different position.
2. **(READY)** indicator on the instrument cluster blinks when the vehicle is in forced engine activation mode. Check the **(READY)** indicator blinking to ensure that the forced engine activation mode is correctly entered.

The **(READY)** indicator continues blinking until the forced engine activation mode is canceled. When the mode is canceled the **(READY)** indicator will stop blinking.

3. To cancel the forced engine activation mode, turn the vehicle off.

Specifications & Consumer information

Dimensions	9-2
Engine	9-2
Gross vehicle weight	9-2
Luggage volume	9-3
Air conditioning system.....	9-3
Bulb wattage	9-4
Tires and wheels	9-5
Recommended lubricants and capacities	9-6
• Recommended SAE viscosity number.....	9-7
Vehicle Identification Number (VIN).....	9-8
Vehicle certification label.....	9-8
Tire specification and pressure label.....	9-8
Engine number.....	9-9
Air conditioner compressor label	9-9
Refrigerant label.....	9-9
Fuel label	9-9
Declaration of conformity	9-10
How to check the symbol on the charging label (For Europe)	9-11

Specifications & Consumer information

Dimensions

Item		mm (in.)	
Overall length		4,420 (174.0)	
Overall width		1,825 (71.9)	
Overall height		1,545 (60.8)	
Tread	Front	205/60 R16	1,585 (62.4)
		225/45 R18	1,573 (61.9)
	Rear	205/60 R16	1,596 (62.8)
		225/45 R18	1,585 (62.4)
Wheelbase		2,720 (107.1)	

Engine

Item	Smartstream G1.6 GDi HEV/PHEV
Displacement [cc (cu in.)]	1,580 (96.4)
Bore x Stroke [mm (in.)]	72.0 x 97.0 (2.83 x 3.81)
Firing order	1-3-4-2
No. of cylinders	4 (inline)

Gross vehicle weight

Item	Gross vehicle weight [kg (lbs.)]
Smartstream G1.6 GDi HEV	1,940 (4,277)
Smartstream G1.6 GDi PHEV	2,060 (4,542)

Luggage volume

- Min: Behind rear seat to upper edge of the of the seatback
- Max: Behind front seat to roof

Item		Volume	
VDA [L (cu ft)]	Smartstream G1.6 GDi HEV	MIN.	451 (15.9)
		MAX.	1,445 (51)
	Smartstream G1.6 GDi PHEV	MIN.	348 (12.3)
		MAX.	1,342 (47.4)

Air conditioning system

Please contact a professional workshop for more details. Kia recommends to contact an authorized Kia dealer/service partner.

Item		Weight of volume (g)	Classification
Refrigerant	HEV	500±25	R-134a
	PHEV	500±25	
	HEV	450±25	R-1234yf
	PHEV	480±25	
Compressor lubricant		120±10	POE

Bulb wattage

*: if equipped

Light bulb		Bulb type	Wattage (Watt)
Head lamp (Type A)	Head lamp (High/Low)	HB3	60
	Turn signal lamps	PY21W	21
	Position and daytime running lamps	LED	LED
Head lamp (Type B)	Head lamp (High)	LED	LED
	Head lamp (High/Low)	LED	LED
	Turn signal lamps	LED	LED
	Position and daytime running lamps	LED	LED
Front and side	Front fog lamps	LED	LED
	Side repeater lamps (Bulb type)	WY5W	5
	Side repeater lamps (LED type)	LED	LED
Rear combination lamp	Stop lamps	LED	LED
	Tail lamps	LED	LED
Rear lower combination lamp (Type A)	Turn signal lamps	PY21W	21
	Rear fog lamp	LED	LED
	Backup lamps	W16W	16
Rear lower combination lamp (Type B)	Turn signal lamps	LED	LED
	Rear fog lamp	LED	LED
	Backup lamps	LED	LED
Rear	High mounted stop lamp	LED	LED
	License plate lamps	W5W	5
Interior	Map lamps (Bulb type)	WEDGE(W10W)	10
	Map lamps (LED type)	LED	LED
	Room lamps (Bulb type)	FESTOON	10
	Room lamps (LED type)	LED	LED
	Vanity mirror lamps*	FESTOON	5
	Glove box lam	W5W	5
	Luggage lamp (Bulb type)	FESTOON	10
	Luggage lamp (LED type)	LED	LED
Ambient light	LED	LED	

Tires and wheels

*1. Load Index

*2. Speed Symbol

Item	Tire size	Wheel size	Load capacity		Speed capacity		Inflation pressure [bar (psi, kPa)]				Wheel lug nut torque kgf·m (lbf·ft, N·m)
			L ^{*1}	kg	SS ^{*2}	km/h	Normal load		Maximum load		
							Front	Rear	Front	Rear	
Full size tire	205/60 R16	6.5Jx16	92	630	H	210	25 (36, 250)				11-13 (79-94, 107-127)
	225/45 R18	7.5Jx18	95	690	V	240					
Compact spare tire (steel wheel)	T125/80 D16	4Tx16	97	730	M	130	420 kpa (60 psi)				
Compact spare tire (alloy wheel)	Compact spare tire's size is based on the full size tire equipped on your vehicle.										

CAUTION

When replacing tires, use the same size originally supplied with the vehicle. Using tires of a different size can damage the related parts or make it work irregularly.

NOTICE

- We recommend that when replacing tires, use the same originally supplied with the vehicles. If not, that affects driving performance.
- When driving in high altitude grades, it is natural for the atmospheric pressure to decrease. Therefore, please check the tire pressure and add more air when necessary.
 - Additionally required tire air pressure per km above sea level: 1.5 psi/km

Recommended lubricants and capacities

To help achieve proper engine and powertrain performance and durability, use only lubricants of the proper quality.

The correct lubricants also help promote engine efficiency that results in improved fuel economy.

These lubricants and fluids are recommended for use in your vehicle.

Lubricant		Volume (L)	Classification
Engine oil ¹ (drain and refill) Recommends  TotalEnergies		3.8	SAE 5W-30, ACEA A5/B5 ²
Dual clutch transmission (DCT) fluid ³		1.6 ~ 1.7	HK D DCTF TGO-10 PLUS (SK), SPIRAX S6 GHDE 70W DCTF PLUS (H.K.SHELL), Kia genuine DCTF 70W SYNTHETIC PLUS
Coolant (Engine) ⁴		6.7	An Phosphate based ethylene glycol based coolant
Coolant (Inverter) ⁴	HEV	1.8	An Phosphate based ethylene glycol based coolant
	PHEV	4.8	Contact an authorized Kia dealer/service partner
Brake fluid		As required	SAE J1704 DOT-4 LV / FMVSS 116 DOT-4 / ISO4925 CLASS-6
Engine clutch actuator fluid		As required	FMVSS116 DOT-3 / FMVSS 116 DOT-4
Fuel	HEV	42	Gasoline
	PHEV	37	

- * 1. Refer to "Recommended SAE viscosity number" on page 9-7.
- * 2. Requires <ACEA A5/B5 Full synthetic> grade engine oil. If a lower grade engine oil (mineral oil including Semi-synthetic) is used, then the engine oil and engine oil filter must be replaced as indicated severe maintenance condition.
- * 3. To maintain your vehicle's best performance, use Kia genuine oil or those of an equivalent standard oil.
- * 4. Different type of coolant or water may damage the electrical component.

Recommended SAE viscosity number

		Temperature Range for SAE Viscosity Numbers									
Temperature	°C	-30	-20	-10	0	10	20	30	40	50	
	°F	-10	0	20	40	60	80	100	120		
Smartstream G1.6 GDI HEV/PHEV		5W-30									



An engine oil displaying this API Certification Mark conforms to the international Lubricant Specification Advisory Committee (ILSAC). It is recommended to only use engine oils that uphold this API Certification Mark.

CAUTION

Always be sure to clean the area around any filler plug, drain plug, or dipstick before checking or draining any lubricant. This is especially important in dusty or sandy areas and when the vehicle is used on unpaved roads. Cleaning the plug and dipstick areas will prevent dirt and grit from entering the engine and other mechanisms that could be damaged.

Engine oil viscosity (thickness) has an effect on fuel economy and cold weather operating (engine start and engine oil flowability). Lower viscosity engine oils can provide better fuel economy and cold weather performance, however, higher viscosity engine oils are required for satisfactory lubrication in hot weather.

Using oils of any viscosity other than those recommended could result in engine damage.

When choosing an oil, consider the range of temperature your vehicle will be operated in before the next oil change. Proceed to select the recommended oil viscosity from the chart.

Vehicle Identification Number (VIN)

Type A - For hybrid vehicle



Type A - For plug-in hybrid vehicle



Type B



The Vehicle Identification Number (VIN) is the number used in registering your vehicle and in all legal matters pertaining to its ownership, etc.

- Type A: Engraved on the floor under the front right seat. Open the cover to check the VIN.
- Type B: Written on a plate attached to the top of the dashboard through the front windshield.

Vehicle certification label (if equipped)



The vehicle certification label attached on the center pillar as shown gives the vehicle identification number (VIN).

Tire specification and pressure label

Type A



Type B



The tire label located on the center pillar as shown gives the tire pressures recommended for your vehicle. The tires supplied on your new vehicle are chosen to provide the best performance for normal driving.

Engine number

Smartstream G1.6 GDi HEV/PHEV



The engine number is stamped on the engine block as shown.

Air conditioner compressor label



A compressor label informs you the type of compressor your vehicle is equipped with such as model, supplier part number, production number, refrigerant (1) and refrigerant oil (2).

Refrigerant label



The refrigerant label is located as shown.

Fuel label (if equipped)

The fuel label is attached on the fuel filler door.

Hybrid vehicle



- A. Octane rating of unleaded gasoline
 1. RON/ROZ: Research Octane Number
 2. (R+M)/2, AKI: Anti Knock Index
- B. Identifiers for Gasoline-type fuels
 - * This symbol means usable fuel. Do not use any other fuel.
- C. For further details, refer to the "Fuel requirements" on page 2-2.

Plug-in hybrid vehicle

For Europe

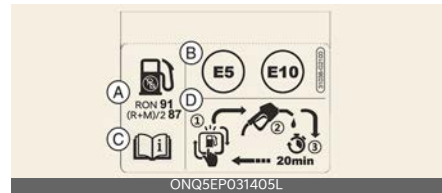

Except Europe



- A. Octane rating of unleaded gasoline

1. RON/ROZ: Research Octane Number
 2. (R+M)/2, AKI: Anti Knock Index
- B. Identifiers for Gasoline-type fuels
 - * This symbol means usable fuel. Do not use any other fuel.
 - C. For further details, refer to the "Fuel requirements" on page 2-2.
 - D. Add fuel into the fuel tank within 20 minutes.

Declaration of conformity

CE CE 0678

The radio frequency components of the vehicle comply with requirements and other relevant provisions of Directive 1995/5/EC.

Further information including the manufacturer's declaration of conformity is available on Kia website as follows:
<http://www.kia-hotline.com>

How to check the symbol on the charging label (For Europe) (if equipped)

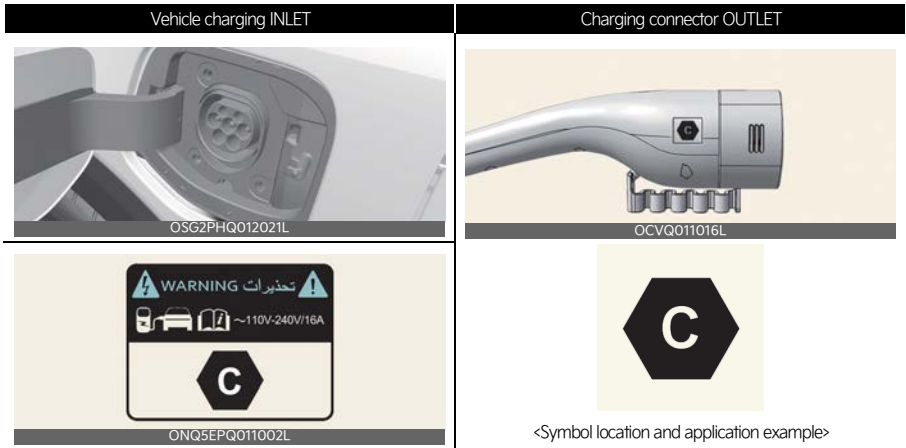

Precautions for charging AC and Trickle charger (Portable charging cable) (AC charging)

1. After opening the charging door, check the charging symbol at the bottom of the warning label.
2. Check the charging connector symbol of the AC and Trickle charger cable.
3. After checking the alphabet letter of the charging symbol, proceed the charging step.
 - * Refer to "Electric charging label symbol table (For Europe)" on page 9-12.
4. Risk of failure, fire, injury, etc. expected when using the charging connector with unmatched symbol.

Electric charging label (For Europe)



The electric charging label is attached on the charging door.

1 ~ 3: Warning for high voltage

4: Identifier for charging door

5: For more details, refer to "How to check the symbol on the charging label (For Europe) (if equipped)" on page 9-11.

6: Charging voltage and current - (~) AC single phase.

7: Identifiers for charging type. For more details, refer to "Electric charging label symbol table (For Europe)" on page 9-12.

Electric charging label symbol table (For Europe)

AC and Trickle charger charging

Supply Type	Configuration	Type of Accessory	Voltage range	Identifier
AC	7P	Vehicle connector and vehicle inlet	≤ 480V RMS	

Abbreviation **A**

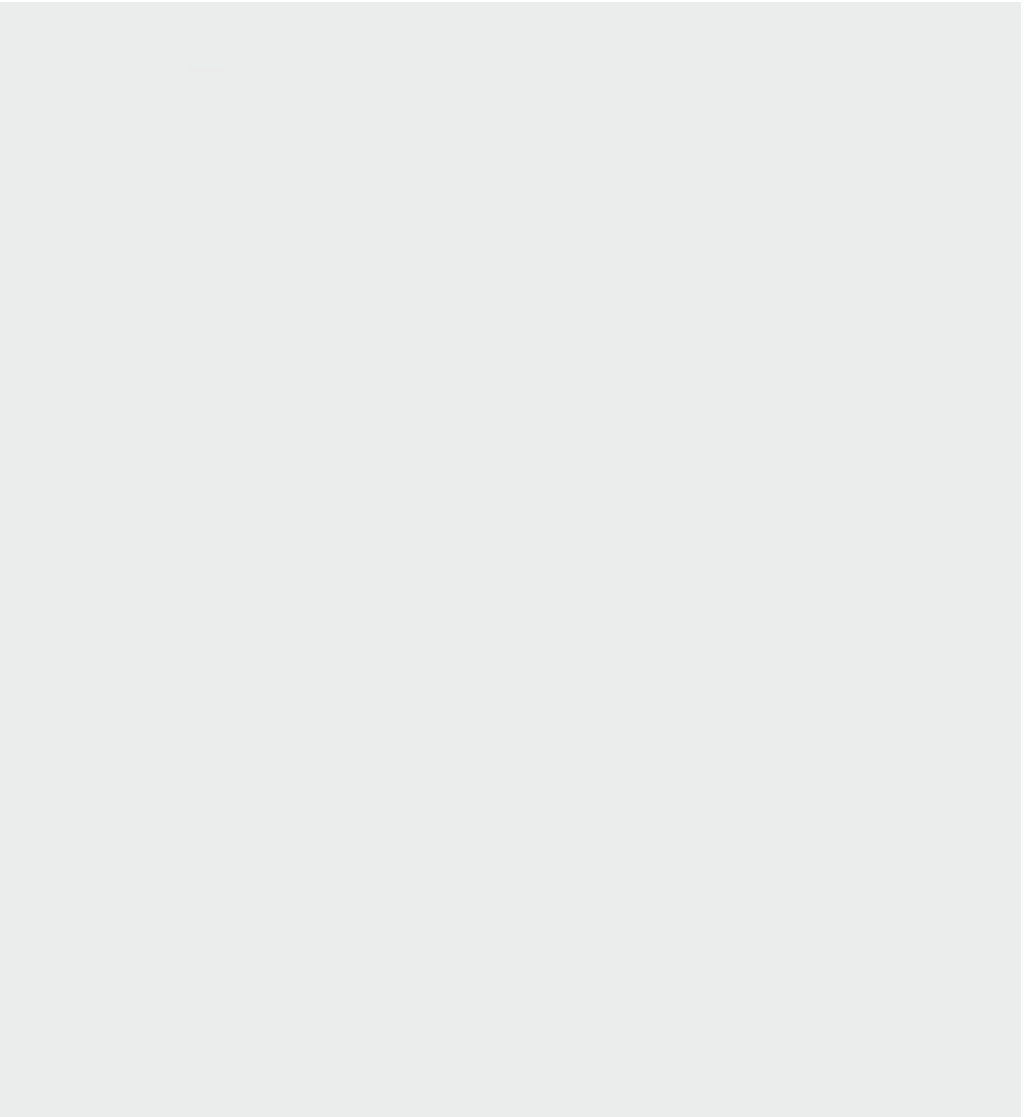

Abbreviation

ABS

Anti-lock Brake System

BAS

Brake Assistant System

BCA

Blind-Spot Collision-Avoidance Assist

SCC

Smart Cruise Control

CRS

Child Restraint System

DAW

Driver Attention Warning

DRL

Daytime Running Light

EBD

Electronic Brake force Distribution

ECM

Electric Chromic Mirror

ESC

Electronic Stability Control

ESS

Emergency Stop Signal

FCA

Forward Collision-Avoidance Assist

HAC

Hill-start Assist Control

HBA

High Beam Assist

HMSL

High Mounted Stop Lamp

ISLA

Intelligent Speed Limit Assist

LATCH

Lower Anchors and Tether for Children

LFA

Lane Following Assist

LKA

Lane Keeping Assist

MCB

Multi-Collision Brake

MDPS

Motor Driven Power Steering

MIL

Malfunction Indicator Lamp

MSLA

Manual Speed Limit Assist

PCA

Reverse Parking Collision-Avoidance Assist

PDW

Reverse Parking Distance Warning

RCCA

Rear Cross-Traffic Collision-Avoidance Assist

RVM

Rear View Monitor

SBW

Shift-By-Wire

Abbreviation

SCC

Smart Cruise Control

SEW

Safe Exit Warning

SEA

Safe Exit Assist

SRS

Supplemental Restraint System

SRSCM

SRS Control Module

TBT

Turn By Turn

TCS

Traction Control System

TIN

Tire Identification Number

TPMS

Tire Pressure Monitoring System

VIN

Vehicle Identification Number

VSM

Vehicle Stability Management

Appendix **A**

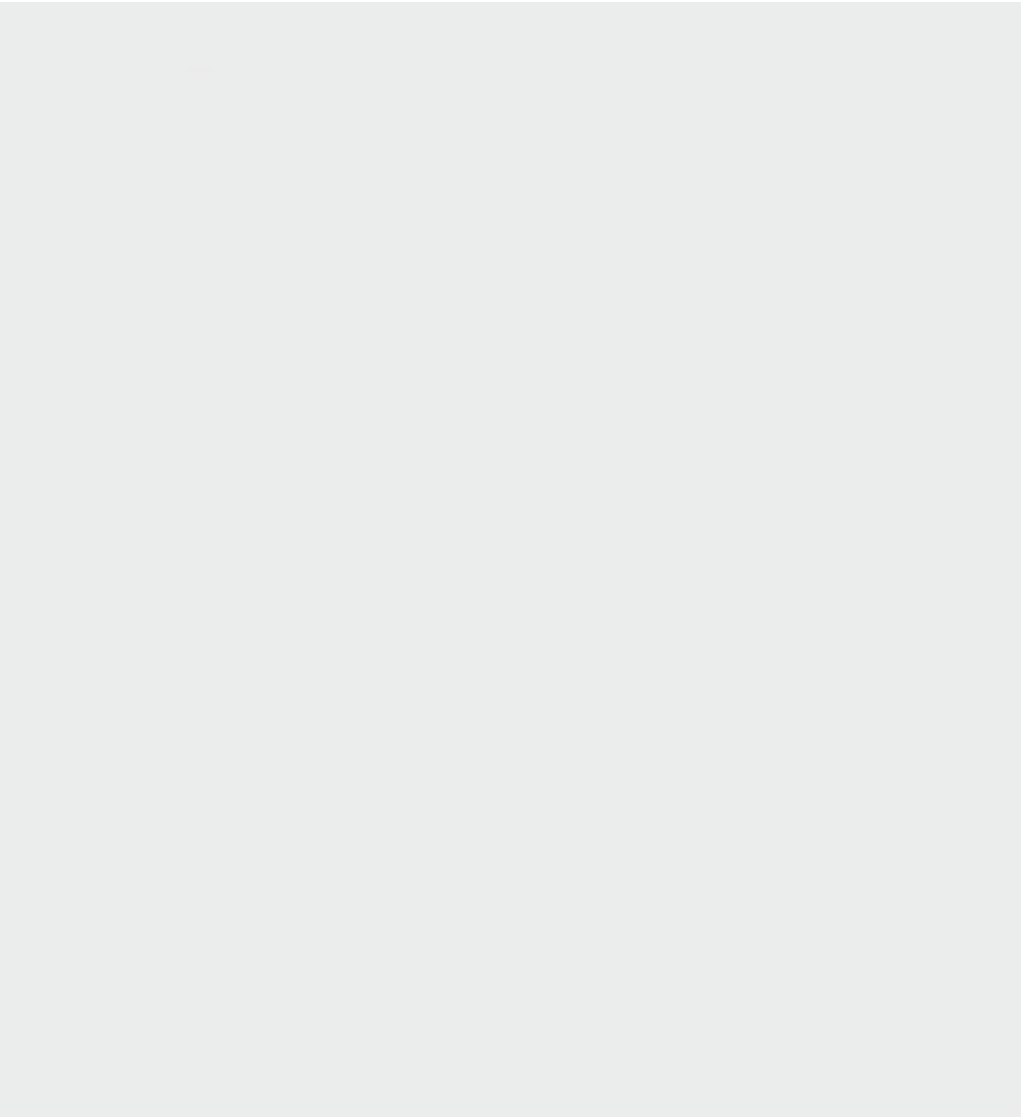

Appendix

Akstur að vetri til

Alvarlegar veðuráðstæður að vetri til leiða til meira slits og annarra vandamála.

Til að lágmarka vandamál í akstri að vetri til ættir þú að fylgja eftirfarandi uppástungum:

Aðstæður í snjó eða hálfu

Til að geta ekið ökutækinu þínu í djúpum snjó kann að vera nauðsynlegt að nota snjóhjólarða eða setja snjókeðjur á hjólin.

Ef þörf er á snjóhjólbörðum er nauðsynlegt að velja hjólarða sem eru jafngildir upprunalegu hjólbörðunum að stærð og tegund. Misbrestur á að gera svo kann að hafa óhagstæð áhrif á öryggi og aksturseginnleika ökutækisins þíns. Ennfremur kunna hraðakstur, snögg hröðun, skyndileg beiting hemla og krappar beygjur hugsanlega að reynast mjög hættuleg iðja.

Meðan á hraðaminnkun stendur skal nota hemla ökutækisins til hins ýtrasta. Skyndileg beiting hemla á snævi þöktum eða ísuðum vegum kann að valda því að bíllinn renni til. Þú þarft að halda hæfilegri fjarlægð frá ökutækinu sem er á ferðinni fyrir framan þitt ökutæki. Beittu einnig hemlunum varlega. Taka ætti fram að uppsetning snjókeðja á hjólarðana veitir meiri aksturskraft en kemur ekki í veg fyrir hliðarskrik.

Snjókeðjur eru ekki löglegar í öllum ríkjum. Athugaðu ríkislög áður en snjókeðjur eru settar á.

Snjóhjólarðar

Ef þú setur snjóhjólarða undir ökutækið þitt skaltu ganga úr skugga um að þeir séu þverbandahjólarðar af sömu stærð og á sama álagssviði og upprunalegu hjólarðarnir. Settu snjóhjólarða á öll fjögur hjólin til að jafna út meðhöndlun ökutækisins við öll veðurskilyrði. Hafðu í huga að gripið sem snjóhjólarðar veita á þurrum vegum kann að vera minna en hjólarðanna sem ökutækið var upphaflega búið. Þú ættir að aka varlega, jafnvel þegar vegurinn er auður. Athugaðu hjá hjólarðasalanum varðandi ráðleggingar um hámarkshraða.

Settu ekki undir neglða hjólarða án þess að athuga fyrst staðbundnar reglugerðir ríkis og bæja vegna mögulegra takmarkana á notkun þeirra.

⚠ VÍÐVÖRUN

Stærð snjóhjólarða

Snjóhjólarðar ættu að vera af jafngildri stærð og tegund og venjulegir hjólarðar ökutækisins. Að öðrum kosti kann það að hafa óhagstæð áhrif á aksturseginnleika ökutækisins.

Keðjur á hjólbarða

snjókeðjur



OSG2H051096

úr dúk



OSG2H051097

Þar sem hliðar þverbandsahjólbarða eru þynnri kunna þeir að skemmast ef sumar tegundir af snjókeðjum eru festar við þá. Þar af leiðandi er mælt með notkun snjóhjólarbarða í stað snjókeðja. Ekki skal setja keðjur á ökutæki sem búin eru álfelgum; snjókeðjur kunna að valda skemmdum á felgunum. Ef það verður að nota snjókeðjur skal nota keðjur úr dúk sem eru innan við 12 mm (0,47 tommur) að þykkt.

Skemmdir á ökutækinu þínu af völdum rangrar notkunar snjókeðja falla ekki undir ábyrgð framleiðandans. Þegar þú notar snjókeðjur skaltu festa þær við drifhjólin sem hér segir.

- Á framhjóladrifnum ökutækjum eru það framhjólin sem gefa aflið. Því verður að setja snjókeðjur á hjólbarðana að framan.
- Á ökutækjum með aldrifi verður að setja snjókeðjur á hjólbarða bæði að framan og aftan. Ef ekki er hægt að komast hjá því skal aðeins setja snjókeðjur á hjólbarðana að framan. Í því tilfalli skal lágmarka akstursvega-

lengd til að koma í veg fyrir skemmdir á aldrifskerfinu.

- Þegar keðjur hafa verið settar á skal aka hægt. Ef þú heyrir hljóð sem verður vegna þess að keðjurnar snerta yfirbygginguna skaltu hægja á þar til hljóðið hættir og fjarlægja keðjuna um leið og þú ferð að aka á hreinsuðum vegum til að koma í veg fyrir skemmdir.
- Röng keðjustærð eða rangt uppsettar keðjur geta skemmt hemlaleiðslur ökutækisins, fjöðrun, yfirbyggingu og hjól. Þar af leiðandi skaltu fylgja leiðbeiningum framleiðandans þegar þú setur á snjókeðjur og festa þær eins þétt og mögulegt er. Aaktu hægt (innan við 30 km/klst.) með uppsettar keðjur.

▲ VARÚÐ

- Gakktu úr skugga um að snjókeðjurnar séu af rétttri stærð og tegund fyrir hjólbarðana þína. Rangar snjókeðjur geta valdið skemmdum á yfirbyggingu ökutækisins og fjöðrun og ekki er víst að þær falli undir ábyrgð framleiðanda ökutækisins. Einnig geta tengikrókar snjókeðjanna skemmt vegna snertingar við ökutækið sem veldur því að snjókeðjurnar losna frá hjólbarðanum. Gakktu úr skugga um að snjókeðjurnar séu í SAE-flokki og „S“-vottaðar.
- Athugaðu alltaf uppsetningu og rétta festingu keðja eftir að hafa ekið um það bil 0,5 til 1 km til að tryggja örugga festingu. Hertu keðjurnar eða settu þær upp aftur ef þær eru lausar.
- Notaðu keðjur úr dúki á ökutæki með 18 tommu (235/60R18) eða 19 tommu (235/55R19) hjólbarða.

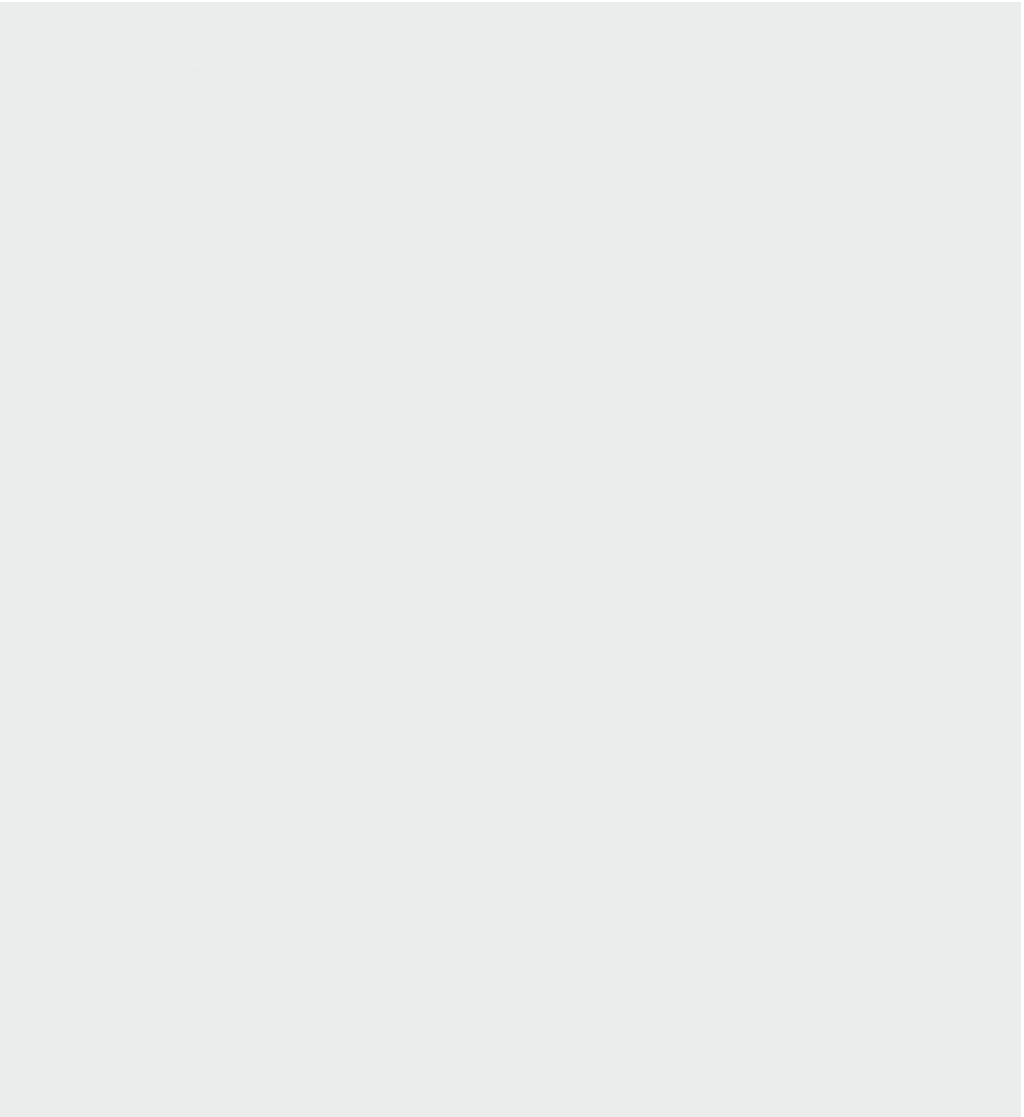

Index

A

AC charge	1-9
AC charging connector lock	1-7
ac inverter	5-102
active air flap	6-42
malfunction	6-42
air bag	
air bag collision sensors	4-46
curtain air bag	4-44
driver's and passenger's front air bag	4-41
inflation conditions	4-47
non-inflation conditions	4-48
side air bag	4-43
SRS care	4-50
SRS components and functions	4-39
warning and indicator	4-36
air bag - supplemental restraint system	4-33
air bag collision sensors	4-46
air cleaner filter	8-30
ambient light	5-99
anti-lock brake system (ABS)	6-37
appearance care	8-70
exterior care	8-70
interior care	8-74
armrest	4-12
ashtray	5-100
audio system	
radio	5-110
auto hold	6-35
automatic climate control system	
controlling fan speed	5-93
using the infotainment/climate switchable controller	5-87, 5-108

B

battery	8-34
before driving	6-6
blind-spot collision-avoidance assist (BCA)	6-70
brake assist system (BAS)	6-40
brake fluid	8-28

brake system	6-31
auto hold	6-35
electronic parking brake (EPB)	6-32
parking brake	6-32
bulb replacement precautions	8-57

C

care of seat belts	4-21
center console storage/glove box	5-96
charging Information	1-4
charging precautions	1-8
charging status	1-5
charging the plug-in hybrid vehicle	1-4
AC charge	1-9
AC charging connector lock	1-7
charging Information	1-4
charging precautions	1-8
charging status	1-5
charging time	1-4
charging type	1-4
how to disconnect charging connector in emergency	1-15
scheduled charging	1-7
trickle charger (portable charging cable)	1-10
charging time	1-4
charging type	1-4
child restraint system (CRS)	4-22
installing a CRS	4-24
ISOFIX anchorage system	4-24
climate control air filter	8-31
climate control system	5-84
closing the hood	5-34
coat hook	5-106
components of the hybrid/plug-in hybrid vehicle	1-30
high voltage service interlock connector	1-36
hybrid vehicle components	1-33
if an accident occurs	1-36
plug-in hybrid vehicle components	1-30
when the hybrid vehicle shuts off	1-37
cruise control (CC)	6-99
cup holders	5-99

curtain air bag 4-44

D

declaration of conformity 6-165

defogging (windshield) 5-94

defrosting (windshield) 5-94

door lock 5-12

door lock/unlock features 5-15

inside the vehicle 5-14

outside the vehicle 5-12

door locks

rear occupant alert (ROA) 5-17

drive mode integrated control system 6-41

drive mode 6-41

driver attention warning (DAW) 6-94

driver position memory system 5-18

easy access function 5-19

recalling memory position 5-18

resetting 5-19

setting memory position 5-18

driver's and passenger's front air bag 4-41

driving the hybrid/plug-in hybrid vehicle 1-16

energy flow 1-26

hybrid system gauge 1-19

LCD display messages 1-20

special features 1-17

starting the vehicle 1-16

warning and indicator lights 1-19

driving the plug-in hybrid vehicle

changing plug-in hybrid mode (plug-in hybrid vehicle) 1-16

dual clutch transmission 5-50, 6-13

E

eCall system 7-33

economical operation 6-173

electronic parking brake (EPB) 6-32

electronic stability control (ESC) 6-37

emergency 7-3

emergency starting 7-5

engine overheats 7-8

flat tire (with spare tire) 7-14

if the engine will not start 7-4

in case of an emergency while driving 7-3

road warning 7-3

towing 7-25

emergency commodity 7-27

emergency stop signal (ESS) 6-39

emergency towing 7-25

emission control system 8-76

Engine clutch actuator fluid 8-29

engine compartment 8-4

engine coolant 8-24

engine oil 8-22

EV button 1-16

exterior features 5-107

roof rack 5-107

F

flat tire (with spare tire) 7-14

floor mat anchors 5-106

forward/reverse parking distance warning (PDW) 6-143

fuel filler door 5-35

fuel requirements 2-2

fuses

driver's side fuse panel 8-48

replacing engine compartment fuse 8-46

replacing inner panel fuse 8-45

G

green zone drive mode for Europe 6-43

H

headlamp leveling adjustment switch 5-78

headrest 4-10

head-up display (HUD) 5-71

HEV (hybrid electric vehicle) system 1-3

high beam assist (HBA) 5-75

high voltage service interlock

connector	1-36
highway driving assist (HDA)	6-123
hill-start assist control (HAC)	6-38
hood	5-33
closing the hood	5-34
opening the hood	5-33
hybrid starter & generator (hsg)	
belt	8-27
hybrid vehicle components	1-33

I

immobilizer system	5-11
infotainment system	5-108
inside rear view mirror	5-45
instrument cluster	5-49
dual clutch transmission	5-50
intelligent speed limit assist (ISLA)	6-89
interior features	5-99
ac inverter	5-102
ambient light	5-99
ashtray	5-100
coat hook	5-106
cup holders	5-99
floor mat anchors	5-106
power outlet	5-103
seat warmer/ventilation	5-100
sun visor	5-101
USB charger	5-102
wireless smart phone charging system	5-104
interior light	5-82
glove box lamp	5-83
luggage room lamp	5-83
map lamp	5-82
room lamp	5-82
vanity mirror lamp	5-83
ISOFIX anchorage system	4-24

K

key	5-5
immobilizer system	5-11
replacing the key battery	5-8

L

lane following assist (LFA)	6-120
LCD display	5-54
LCD display modes	5-54
LCD display modes	
driver assistance settings (infotainment system)	5-61
driving assist mode	5-55
information mode	5-57
master warning mode	5-58
service Interval	5-58
trip computer mode	5-55
turn by turn (TBT) mode	5-57
light bulbs	8-57
bulb replacement precautions	8-57
light position (front)	8-58
light position (rear)	8-59
light position (side)	8-59
replacing license plate lamp (Bulb type)	8-62
replacing lights (LED type)	8-59
replacing side repeater lamp (Bulb type)	8-61
lighting	5-73
high beam assist (HBA)	5-75
loading your vehicle - for australia	6-187
luggage board	5-97

M

maintenance	
air cleaner filter	8-30
appearance care	8-70
battery	8-34
brake fluid	8-28
climate control air filter	8-31
emission control system	8-76
engine clutch actuator fluid	8-29
engine coolant	8-24
engine oil	8-22
tires and wheels	8-37
washer fluid	8-30
wiper blades	8-32
maintenance services	8-6
owner maintenance schedule	8-7

manual speed limit assist (MSLA)	6-87
mirrors	5-45
adjusting the day/night rear view mirror	
electric chromic mirror (ECM)	5-45
inside rear view mirror	5-45
outside rear view mirror	5-46
multi-collision brake (MCB)	6-38

N

navigation-based smart cruise control (NSCC)	6-114
---	-------

O

Open Source Software Notice	2-6
opening the hood	5-33
outside rear view mirror	
auto reverse function	5-47

P

paddle shifter	6-23
Pan-European eCall system	7-28
pan-european ecall system	
description of the ecall in-vehicle system	7-29
information on data processing	7-29
passenger's front air bag ON/OFF	
settings	4-36
PHEV (plug-in hybrid electric vehicle) system	1-2
plug-in hybrid vehicle components	1-30
portable charge	
charging status indicator lamp for portable charger	1-12
how to connect	1-10
power outlet	5-103
power tailgate	5-20
automatic reversal	5-21
resetting	5-24
setting power tailgate	5-23

R

rear cross-traffic collision-avoidance assist (RCCA)	6-132
rear occupant alert (ROA)	5-17
rear view monitor (RVM)	6-128
regenerative braking system	
adjusting with paddle shifter	6-23
relaxion comfort seat	4-5
remote key	5-5
remote smart parking assist (RSPA)	6-155
replacing lights (LED type)	8-59
reverse parking collision-avoidance assist (PCA)	6-148
reverse parking distance warning (PDW)	6-140
malfunction and precautions	6-141
operation	6-141
settings	6-140
Risk of burns when parking or stopping vehicle	2-6
roof rack	5-107

S

safe exit warning (SEW)	6-79
malfunction and limitations	6-81
operation	6-80
scheduled charging	1-7
scheduled maintenance items	8-20
air cleaner filter	8-20
air conditioning refrigerant	8-21
brake discs, pads and calipers	8-21
brake fluid	8-21
brake hoses and lines	8-21
coolant/inverter coolant	8-21
cooling system	8-21
drive belts	8-20
drive shafts and boots	8-21
dual clutch transmission (DCT) fluid	8-21
fluid levels	8-21
fuel filter	8-20
fuel lines, fuel hoses and connections	8-20
spark plugs (for gasoline engine)	8-20

steering gear box, linkage & boots/lower arm ball joint	8-21	center console storage/glove box	5-96
suspension mounting bolts	8-21	luggage board	5-97
vapor hose and fuel filler cap	8-20	sun visor	5-101
scheduled maintenance service	8-9	sunroof	5-39
seat	4-3	automatic reversal	5-40
feature of seat leather	4-4	resetting the sunroof	5-41
seat belt precautions	4-19	slide open/close	5-40
seat belt restraint system	4-13	sunroof open warning	5-42
seat belts	4-12	sunshade	5-39
seat leather	4-4	tilt open/close	5-39
seat warmer/ventilation	5-100		
side air bag	4-43	T	
smart cruise control (SCC)	6-102	tailgate	5-20
smart key	5-6	emergency safety release	5-27
smart regeneration system	6-25	opening the smart tailgate	5-25
activation	6-26	tailgate emergency safety release	5-27
basic setting of smart regeneration system	6-27	theft-alarm system	5-9
limitation	6-28	armed stage	5-9
malfunction	6-28	disarmed stage	5-9
resuming	6-27	theft-alarm stage	5-9
setting	6-25	tire mobility kit	7-20
smart tailgate	5-25	checking tire inflation pressure	7-23
special driving conditions	6-173	components of the tire mobility kit	7-21
specifications	9-2	distributing the sealant	7-22
air conditioner compressor label	9-9	safe use of the tire mobility kit	7-24
air conditioning system	9-3	using the tire mobility kit	7-22
bulb wattage	9-4	tire pressure monitoring system (TPMS)	7-9
declaration of conformity	9-10	tires and wheels	8-37
dimensions	9-2	checking tire inflation pressure	8-37
engine	9-2	low aspect ratio tire	8-43
engine number	9-9	recommended cold tire inflation pressures	8-37
fuel label	9-9	tire care	8-37
gross vehicle weight	9-2	tire maintenance	8-40
lubricants and capacities	9-6	tire replacement	8-39
luggage volume	9-3	tire rotation	8-38
refrigerant label	9-9	tire sidewall labeling	8-40
tire specification and pressure label	9-8	tire traction	8-40
tires and wheels	9-5	wheel alignment and tire balance	8-39
vehicle certification label	9-8	wheel replacement	8-40
vehicle identification number (VIN)	9-8	towing	7-25
starting the vehicle	6-9	emergency towing	7-25
steering wheel	5-42	towing service	7-25
heated steering wheel	5-44	towing service	7-25
horn	5-45	trailer towing	6-180
storage compartment	5-96		

driving with a trailer	6-182
hitches	6-181
maintenance	6-184
safety chains	6-182
trailer brakes	6-182
transmission	6-13
LCD display messages	6-18
trickle charger (portable charging cable)	1-10
trip information (Trip computer)	
energy flow	5-57
range	5-57

wiper blades	8-32
wipers and washers	5-78
wireless smart phone charging system	5-104

U

USB charger	5-102
--------------------	-------

V

vehicle break-in process	2-5
vehicle handling instructions	2-4
vehicle modifications	2-4
vehicle safety system	6-37
anti-lock brake system (ABS)	6-37
brake assistant system (BAS)	6-40
electronic stability control (ESC)	6-37
emergency stop signal (ESS)	6-39
hill-start assist control (HAC)	6-38
multi-collision brake (MCB)	6-38
vehicle stability management (VSM)	6-39
vehicle settings (infotainment system)	5-65
vehicle stability management (VSM)	6-39
vehicle weight	6-187
loading your vehicle - for australia	6-187

W

warning and indicator lights	5-67
washer fluid	8-30
windows	5-28
power window lock button	5-31
remote window closing/opening	5-31
windshield defrosting and defogging	5-94
winter driving	6-177

